



C186F

Caple In Column Integrated Freezer



**INSTRUCTION
MANUAL**

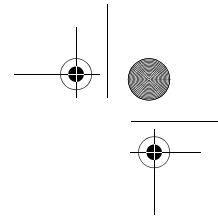
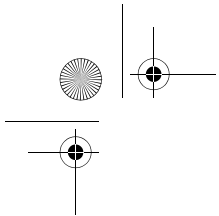

INSTRUCTIONS FOR USE

BEFORE USING THE APPLIANCE

SAFEGUARDING THE ENVIRONMENT

**PRECAUTIONS AND GENERAL
RECOMMENDATIONS**

HOW TO USE THE FREEZER

HOW TO DEFROST AND CLEAN THE FREEZER

TROUBLESHOOTING GUIDE

AFTER-SALES SERVICE

INSTALLATION

ELECTRICAL CONNECTION

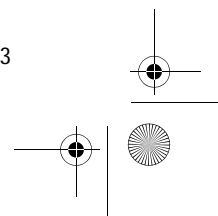
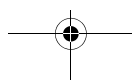
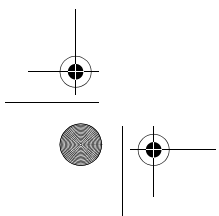
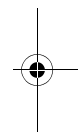
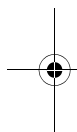

BEFORE USING THE APPLIANCE

- Your new appliance is designed exclusively for domestic use

To get the most out of your new appliance, read the user handbook thoroughly. The handbook contains a description of the appliance and useful tips for storing food. Keep this handbook for future consultation.

- After unpacking, make sure that the appliance is undamaged and that the door closes properly. Any damage must be reported to your dealer within 24 hours after delivery of the appliance.
- Wait at least two hours before switching the appliance on in order to ensure the refrigerant circuit is fully efficient.
- Installation of the appliance and electrical connections must be carried out by a qualified electrician, in accordance with the manufacturer's instructions and local safety regulations
- Clean the inside of the appliance before using it.

SAFEGUARDING THE ENVIRONMENT

1. Packing

The packaging material is entirely recyclable, and marked with the recycling symbol. Follow local regulations for scrapping. Keep the packaging materials (plastic bags, polystyrene parts, etc.) out of reach of children, as they are potentially dangerous.

2. Scrapping

The appliance is manufactured using recyclable material.

This appliance is marked according to the European directive 2002/96/EC on Waste Electrical and Electronic Equipment (WEEE). By ensuring this product is disposed of correctly, you will help prevent potential negative consequences for the environment and human health, which could otherwise be caused by inappropriate waste handling of this product.

The symbol  on the product, or on the documents accompanying the product, indicates that this appliance may not be treated as household waste. Instead it shall be handed over to the applicable collection point for the recycling of electrical and electronic equipment. Before scrapping, make the appliance unusable by cutting off the power cable and removing the doors and shelves so that children cannot easily climb inside the appliance.

Disposal must be carried out in accordance with local environmental regulations for waste disposal. Deliver the appliance immediately to an authorized dump; do not leave it unattended even for a few days, since it is potentially dangerous for children. For more detailed information about treatment, recovery and recycling of this product, please contact your local city office, your household waste disposal service or the shop where you purchased the product.

Information:

This appliance does not contain CFCs (replaced with R134a) or HFCs (replaced with R600a). Appliances with Isobutane (R600a): isobutane is a naturally occurring, low environmental impact gas. Caution is required, however, because isobutane is flammable. Therefore, it is essential to ensure that refrigerant pipelines are not damaged.

Declaration of conformity

- This appliance is designed to store food and is manufactured in conformity with EEC directive No. 89/109/EEC, 90/128/EEC, 02/72/EEC.

CE

- This appliance is designed, manufactured, and retailed in compliance with:
 - the safety objectives of the Low Voltage Directive 73/23/EEC;
 - the protection requirements of the "EMC" Directive 89/336/EEC amended by Directive 93/68/EEC;
- the electrical safety of the appliance can only be guaranteed if the product is connected to an approved earth connection.



PRECAUTIONS AND GENERAL RECOMMENDATIONS

- Use the refrigerator compartment only for storing fresh food and beverages and use the freezer compartment only for storing frozen food, freezing fresh food and making ice cubes.
- After installation, make sure that the appliance is not standing on the power supply cable.
- Do not store glass containers with liquids in the freezer since they may burst.
- Do not eat ice cubes or ice lollies immediately after taking them out of the freezer since they may cause cold burns.
- Before carrying out any maintenance or cleaning, always unplug the appliance or disconnect the power supply.
- Make sure that the appliance is not near a heat source.
- Do not store or use gasoline or other flammable vapours and liquids in the vicinity of this or any other appliance. The fumes can create a fire hazard or explosion.
- To ensure proper ventilation leave a 1 cm space on both sides and above the refrigerator.
- Ensure that the vent outlets on the appliance casing or housing unit are unobstructed in order to allow correct air circulation.
- All appliances equipped with an ice maker or water dispenser must be connected to a mains water supply that delivers potable water only (with water pressure between 1.7 and 8.1 bar (25 and 117 PSI)). Ice makers and/or water dispensers not directly connected to a mains water supply must be filled with potable water only.
- Install and level the appliance on a floor strong enough to take its weight and in an area suitable for its size and use.

- Install the appliance in a dry and well-ventilated place. The appliance is set for operation at specific ambient temperature ranges, according to the climatic class indicated on the data plate: The appliance may not work properly if it is left for a long period at a temperature above or below the indicated range.

Climatic class	Amb. T. (°C)	Amb. T. (°F)
SN	From 10 to 32	From 50 to 90
N	From 16 to 32	From 61 to 90
ST	From 18 to 38	From 64 to 100
T	From 18 to 43	From 64 to 110

- Be careful not to damage the floors when you move the appliance (e.g. parquet flooring).
- Do not use mechanical devices or any means other than those recommended by the manufacturer to speed up the defrosting process.
- Do not damage the refrigerant circuit.
- Do not use electrical appliances inside the freezer compartments, unless such appliances are specifically recommended by the manufacturer.
- This appliance is not designed for use by young children or the infirm.
- To avoid the risk of children being trapped and therefore suffocating, do not allow them to play or hide inside the appliance.
- The power cable may only be replaced by an authorized person.
- Do not use extension leads or adapters.
- It must be possible to disconnect the appliance from the mains by unplugging it or by means of a two-pole switch fitted upline of the socket.
- Ensure that the voltage indicated on the appliance data plate corresponds to the domestic supply voltage
- Do not swallow the contents (non-toxic) of the ice packs (if provided).

HOW TO USE THE FREEZER

The freezer can be used for storing already frozen food and for freezing fresh food. The amount of fresh food (in kg) that can be frozen in 24 hours is indicated on the appliance data plate. The freezer can operate at ambient temperatures between +10°C and +32°C. Optimal performance is obtained at temperatures between +16°C and +32°C.

Switching on the freezer for the first time

- There is no need to set the freezer temperature on the thermostat because the appliance is already factory set.
- Plug in the appliance. The green LED (indicating that the appliance is ON) and the red LED will light up, and on some models also the acoustic alarm (if provided) will sound after about 1 minute, indicating that the freezer has not yet reached a sufficiently cold temperature for storage of foodstuffs.
- To mute the acoustic alarm press the fast freeze button; the yellow LED will light up.
- Deactivate the fast freeze function when the red LED goes out.

Adjusting the thermostat

Select the freezer compartment temperature using the thermostat knob:

1 = Minimum freezing power

4 = Maximum freezing power

Ambient air temperature, the frequency of door opening and the amount of food to freeze can affect the freezer temperature adjustments.

We therefore recommend starting with a medium temperature setting 2 - 3.

Function of LEDs and acoustic alarm (if present)

The green LED indicates whether the appliance is ON. The red LED (and the acoustic alarm on some models) indicates that the internal temperature of the appliance is not suitable for storing food.

This occurs:

- After switching on the appliance.
- When the appliance is switched on again after defrosting and cleaning operations.
- When too much fresh food is placed in the freezer.
- When the door is not closed properly.
- When the cooling system is faulty (see "Troubleshooting guide").
- When the thermostat is set to higher values (lower temperatures).

The yellow LED indicates that the fast freeze function is activated. When it is selected, it also mutes the acoustic alarm (on some models only).

Freezers with door contact rod

The acoustic alarm sounds when the door has been left open for more than 1 minute. The alarm stops when the door is closed. If it is necessary to leave the freezer door open for more than 1 minute (e.g. to rearrange food in the drawers), the alarm can be deactivated by pulling the rod (see figure).

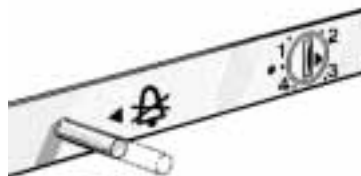

HOW TO USE THE FREEZER

Fast freeze operation

To freeze the maximum amount of food, press the fast freeze button 24 hours before placing fresh food in the freezer. The recommended amount of food to be frozen is indicated on the data plate on the inside of the appliance. When putting food in to freeze, the red LED may light up until the ideal temperature is reached.

hours after placing the food in to freeze, deactivate the fast freeze function.

Tips for freezing and storing fresh food

- Before freezing, wrap and seal fresh food in: aluminium foil, plastic wrap, cling film, polyethylene containers with lids, and other containers provided they are suitable for freezing foods.
- Foodstuffs (except meat, see below) must be fresh, mature and of prime quality in order to obtain high quality frozen food.
- Fresh vegetables and fruit should preferably be frozen as soon as they are picked to maintain the full original nutritional value, consistency, colour and flavour.

Some meat, especially game, should be hung before it is frozen.

Note:

- Always leave hot food to cool before placing in the freezer.
- Use fully or partially defrosted foods immediately. Do not refreeze unless the food is cooked after it has thawed. Once cooked, the thawed food can be refrozen.

Freezing and storing fresh food

- Place foods to be frozen in the two upper baskets.
- When the freezer is used without the rack, place the ice packs above the food to be frozen at the front of the top drawer.

Important:

The table alongside shows the recommended maximum storage time for frozen fresh foods.

Classification of frozen foods

Put the frozen products into the drawers (baskets) and classify them.

For correct use, follow the storage life indications on the table.

Tip for checking frozen food

Place a low temperature thermometer in the middle of the frozen food to check the temperature.

Do not place it on the frozen food which would determine the temperature of the air and not the temperature of the food.



MONTHS	FOOD
1-3	
4-7	
8-12	

HOW TO USE THE FREEZER

Advice for storing frozen food

When purchasing frozen food products:

- Ensure that the packaging is not damaged (frozen food in damaged packaging may have deteriorated). If the package is swollen or has damp patches, it may not have been stored under optimal conditions and defrosting may have already begun.
- When shopping, leave frozen food purchases until last and transport the products in a thermally insulated cool bag.
- Once at home, place the frozen foods immediately in the freezer.
- If food has defrosted even partially, do not re-freeze it. Consume within 24 hours.
- Avoid subjecting foods to temperature variations. Observe the "best before" date on the package.
- Always observe the storage information on the package.

Removing the baskets

- Pull the baskets out as far as they come, then lift up slightly and remove.
- Pull the lower basket out fully, then rotate it slightly in order to remove.

Note on overall capacity

The overall capacity has been calculated without the rack and without the three upper baskets. For increased storage space, the freezer compartment can be used without the two upper baskets, e.g. to freeze poultry or the like.

Making ice cubes

- Fill the ice cube tray 2/3 full and place it in the tray or in a basket.
- Use a spoon handle to detach the tray if it is stuck to the bottom of the freezer. Do not use sharp or pointed instruments.
- Bend the ice tray slightly to remove the cubes.
- If the tray is made of aluminium, pour water on the bottom of the tray.

Note:

If the freezer door does not re-open immediately after closing, wait two or three minutes in order to allow for compensation of the vacuum created.

Switching off the freezer

- Turn the thermostat anti-clockwise to ●.
- The green LED goes out, as well as any other LED that is alight; The appliance is still connected to the mains power supply.



HOW TO DEFROST AND CLEAN THE FREEZER

Before any cleaning or maintenance operation, unplug the appliance from the mains or disconnect the electrical power supply. Defrost the freezer compartment once or twice a year, or when the ice on the walls reaches a thickness of about 3 mm. If possible, defrost the freezer when it is nearly empty.

- If there are still frozen foods in the freezer, press the fast freeze button a few hours before defrosting to further chill the food.
- Remove the food from the freezer, wrap in newspaper and group together in a cool place or in a portable cooler.
- **Disconnect the freezer from the mains power supply.**
- Leave the door open to allow the ice to melt.
- Pull out the defrost water drain and place a container under the drain.
- Clean the interior of the freezer with a sponge and warm water and/or neutral detergent.
Do not use abrasive substances.
- Rinse the interior and dry thoroughly.
- Close the freezer and activate the fast freeze function. Arrange the food and a few hours later deactivate the fast freeze function.

Prolonged disuse

- Empty the freezer.
- Disconnect the freezer from the mains power supply.
- Defrost and clean.
- Leave the doors open to prevent formation of unpleasant odours.

Door seal

- From time to time clean the door seal with water and then dry well.
Do not use oil or grease.

Important

- Ensure that the vent outlets are unobstructed in order to allow correct air circulation.





TROUBLESHOOTING GUIDE



1. If your refrigerator does not work.

- Is there a power failure?
- Is the plug properly inserted in the socket?
- Has the fuse blown?
- Is the power cord damaged?
- Is the thermostat set to ●?

2. Temperature inside the compartments is not low enough.

- Are the doors closed properly?
- Is the appliance installed near a heat source?
- Is the thermostat setting correct?
- Are the air circulation vents blocked?

3. Temperature inside the freezer is too low.

- Is the thermostat setting correct?

4. Water collects at the bottom of the freezer.

- Have you cleaned the freezer well before switching it on again?
- Is the appliance connected and working properly?
- Is the door shut properly?









5. The yellow, red and green leds do not light up. Perform the checks for point 1, then contact After-sales Service.

6. The red LED is permanently alight and the acoustic alarm (if provided) sounds.

Check:

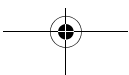
- Was the appliance switched on correctly?
- Has too much food been frozen at once?
- Is the door shut properly?
- Is the freezer faulty?
- Is the thermostat setting too high?

Notes:

- The front edge of the appliance may be hot. This prevents the formation of condensation and is not a defect.
 - Gurgling and hissing noises due to expansion in the refrigerant circuit are normal.
- 
- 
- 
- 
- 
- 
- 
- 
- 

AFTER-SALES SERVICE

Before contacting After-Sales Service:

1. See if you can solve the problem yourself with the help of the "Troubleshooting guide".
2. Switch the appliance on again to see if the problem has been solved. If it has not, disconnect the appliance from the power supply and wait for about an hour before switching on again.
3. If the problem persists after this course of action, contact After-sales Service.

Specify:

- the nature of the problem,
- the model,

- the Service number (the number after the word SERVICE on the data plate),
- your full address,
- your telephone number and area code.

SERVICE 0000 000 00000



Note:

The direction of door opening can be changed. If this operation is performed by After-sales Service it is not covered by the warranty.

INSTALLATION

- Install the appliance away from heat sources. Installation in a hot environment, direct exposure to the sun or installation near heat sources (heaters, radiators, cookers) will increase power consumption and should therefore be avoided.

If this is not possible, the following minimum distances must be observed:

- 30 cm from coal or paraffin stoves
- 3 cm from electric stoves.
- Install the appliance in a dry, well-ventilated place.
- Clean the interior (see "How to defrost and clean the freezer").
- Fit the accessories.
- Check the door seal is not damaged or deformed, especially after installation or reversal of door opening.

Electrical connection

- **Electrical connections must be made in accordance with local regulations.**
- Voltage and power consumption are indicated on the rating plate inside the appliance.
- **Regulations require that the appliance is earthed. The manufacturer declines all liabilities for injury to persons or animals or damage to property resulting from failure to observe these regulations.**
- If the plug and socket are not of the same type, have the socket replaced by a qualified electrician.
- Do not use extension leads or adapters.

Disconnecting the appliance

- It must be possible to disconnect the appliance by unplugging it or by means of a two-pole switch fitted upline of the socket.

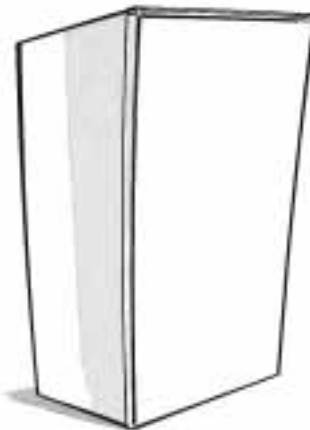

ELECTRICAL CONNECTION

1) For Great Britain only

Warning - this appliance must be earthed

Fuse replacement

If the mains lead of this appliance is fitted with a BS 1363A 13amp fused plug, to change a fuse in this type of plug use an A.S.T.A. approved fuse to BS 1362 type and proceed as follows:

1. Remove the fuse cover (A) and fuse (B).
2. Fit replacement 13A fuse into fuse cover.
3. Refit both into plug.

Important:

The fuse cover must be refitted when changing a fuse and if the fuse cover is lost the plug must not be used until a correct replacement is fitted.

Correct replacement are identified by the colour insert or the colour embossed in words on the base of the plug.

Replacement fuse covers are available from your local electrical store.

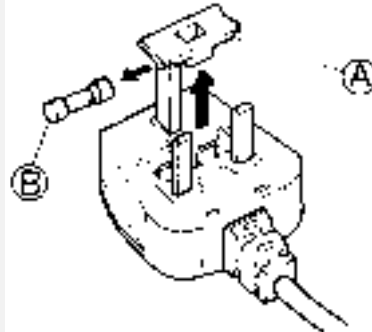

2) For the Republic of Ireland only

The information given in respect of Great Britain will frequently apply, but a third type of plug and socket is also used, the 2-pin, side earth type.

3) Socket outlet / plug (valid for both countries)

If the fitted plug is not suitable for your socket outlet, please contact Whirlpool Service for further instruction. Please do not attempt to change plug yourself. This procedure needs to be carried out by a qualified Whirlpool technician in compliance with the manufactures instructions and current standard safety regulations.

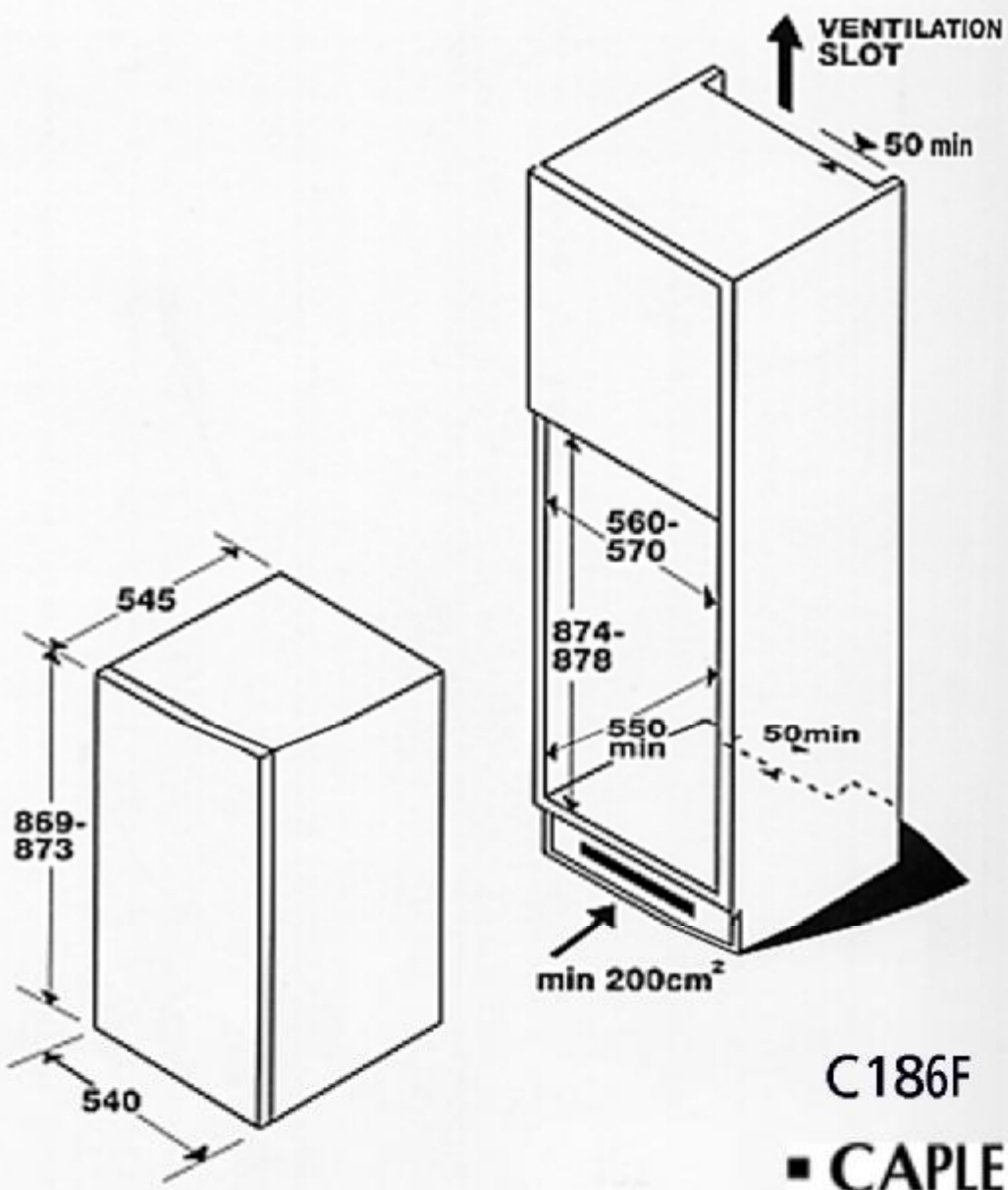

C186F
■ CAPLE ■