



Built-In Fridge Instruction Manual

RIL1796



Contact Caple on 0117 938 7420 for spare parts or www.caple.co.uk

CONTENTS

Warnings	3
Environmental Protection	11
Electrical Connection	12
Ventilation Requirements	13
Product Overview	14
Using The Appliance	15
Operating Your Fridge	17
Humidity Controlled Drawer	20
Easy Adjustable Door Shelf	21
Caple Fresh	22
Food Storage	23
Cleaning And Maintenance	25
Transport And Repositioning	27
Troubleshooting	28
Energy Saving Tips	30
Caple Contact Details	32

SAFETY INSTRUCTIONS

Read these instructions carefully and completely before using your appliance. They provide you with important information regarding the safe installation, use and maintenance of the appliance as well as useful advice for getting the best out of your fridge. Keep this booklet in a safe place for future reference and pass on to any future owner.

- This appliance is produced in accordance with all applicable local and international standards and regulations.
- This appliance is intended to be used in household and similar applications such as:
 - › Staff kitchen areas in shops, offices and other working environments.
 - › Farm Houses.
 - › By clients in hotels, motels and other residential type environments.
 - › Bed and breakfast type environments.
- This appliance may only be used by persons (including children) with reduced physical, sensory or mental capabilities, or lack of experience and knowledge, if they are supervised whilst using it. They may only use it unsupervised if they have been shown how to use it in a safe manner. They must be able to recognise and understand the dangers of misuse.

SAFETY WITH CHILDREN:

- This appliance can be used by children aged from 8 years and above.
- Children less than 8 years of age should be kept away unless continuously supervised or they have been shown how to use it in a safe manner. Children must be able to understand and recognise the possible dangers caused by incorrect operation.
- Children should be supervised in the vicinity of the appliance.
- Never allow children to play with the appliance.
- Cleaning and user maintenance should not be carried out by children without supervision.
- Children aged from 3 to 8 years are allowed to load and unload refrigerating appliances.
- Materials used for packaging (nylon, staplers, Styrofoam etc.) may cause harmful effects to children, they should be disposed of immediately.
- Children can injure themselves on an open door. Do not let children sit on the open door, lean against it or swing on it.

TECHNICAL SAFETY:

- Maintenance and repair work must be made only by authorised Caple service technicians. Installation and repair work that is carried out by unauthorised technicians may endanger you.

- While the appliance is under warranty, repairs should only be undertaken by a Caple authorised service technician. Otherwise the warranty will be invalidated.
- It is dangerous to alter or modify the specifications of the appliance in any way. The requirements for this appliance are stated on the rating label.
- Risk of injury due to electric shock. Any contact with live connections or tampering with the electrical or mechanical components of the appliance will endanger your safety and may lead to the appliance malfunctioning.
- To maintain the efficiency and safety of your appliance, we recommend you always use original spare parts and to call only our authorised Caple Service agents in case of need.
- Multi-socket adapters and extension leads should not be used to connect the appliance to the mains electricity supply.
- The electrical system of this appliance may be used safely only when it is correctly connected to an efficient earthing system in compliance with the safety standards currently in effect.
- Insert the plug into a socket with an efficient ground connection. If the socket has no ground contact or the plug does not match, we recommend you consult a qualified electrician for assistance.
- The appliance must be connected with a properly installed fused socket. The power supply (AC) and voltage at the operating point must match with the

details on the rating plate of the appliance.

- Consult a qualified electrician or service person if the Grounding instructions are not completely understood, or if you have doubts on whether the appliance is properly grounded.
- The incorrect grounding may cause breakdown and electric shock.
- We do not accept responsibility for any damages that occur due to ungrounded usage.
- If the socket does not match the refrigerator plug, it must be replaced by the manufacturer, a service agent or similarly qualified persons in order to avoid a hazard.
- A specially grounded plug has been connected to the power cable of your refrigerator. This plug should be used with a specially grounded socket of 13 amperes. If there is no such socket in your house, please have one installed by an authorised electrician.

INSTALLATION WARNINGS:

- Prior to installation, ensure that the local distribution conditions (electricity voltage and frequency) and the requirements of the appliance are compatible.
- During installation the appliance must be completely disconnected from the mains electricity supply.
- Do not operate the appliance before it is fully installed.
- The appliance must be installed by an authorised technician.

- **⚠ WARNING:** In order to avoid any hazards resulting from the instability of the appliance, it must be fixed in accordance with the following instructions.
- This appliance is not intended for use at altitudes exceeding 2000m.
- Your appliance must be at least 50 cm away from stoves, gas ovens and heater cores, and at least 5 cm away from electrical ovens.
- If your fridge is placed next to a deep fridge, there must be at least 2cm between them to prevent humidity forming on the outer surface.
- Do not cover the body or top of fridge with lace. This will affect the performance of your fridge.
- Clearance of at least 150 mm is required at the top of your appliance. Do not place anything on top of your appliance.
- Caple is not responsible for any damage that may be caused by defective placement and installation by unauthorised persons.
- When unpacking the appliance, make sure that it is not damaged during transportation.
- Check the appliance for any damage.
- In the case of any defect; do not use the appliance and contact your retailer or Caple Service immediately.
- **⚠ WARNING:** When positioning the appliance, ensure the supply cord is not trapped or damaged. If the supply cord is damaged, it must be replaced by a Caple service technician or similarly qualified persons in order

to prevent a hazard.

- Never touch the power cord/plug with wet hands. This may cause a short circuit or electric shock.
- The plug must be accessible after installation.
- **⚠ WARNING:** Do not locate multiple portable socket-outlets or portable power supplies at the rear of the appliance.
- Protect your appliance against atmospheric effects. Do not expose it to effects such as sun, rain, snow etc.

DURING USE:



- Do not store explosive substances such as aerosol cans with a flammable propellant in this appliance.
- Place drinks with high alcohol content vertically in the fridge compartment and make sure their tops are tightly closed.
- If you know you will not be using the appliance for a while switch it off from the main supply and unplug it.
- **⚠ WARNING:** Keep ventilation openings, in the appliance enclosure or in the built-in structure, clear of obstruction.
- Do not place your appliance on a carpeted surface as this will prevent adequate ventilation.
- When the appliance is not in use, we recommend you turn it off, and isolate it from the electrical supply.
- This appliance must be used in the vertical position on a flat surface.

-  **WARNING:** Do not use electrical appliances inside the food storage compartments of the appliance, unless they are of the type recommended by the manufacturer.
- The manufacturer will not be held liable for any damages that might arise out of incorrect or improper use of the appliance.

CLEANING AND MAINTENANCE:

- Clean the appliance thoroughly before use.
- Always switch off the appliance from the mains isolating the electrical supply before any cleaning or maintenance.
-  **WARNING:** Do not use mechanical devices or other means to accelerate the defrosting process, other than those recommended by the manufacturer.

TRANSPORT:

-  **WARNING:** Do not damage the refrigerant circuit.
- Always transport the appliance in its original packaging and in an upright position.
-  If your appliance uses R600a as a refrigerant, you should take care during transportation and installation to prevent the cooler elements from being damaged. R600a is an environmentally friendly and natural gas, but it is explosive. In the event of a leak due to damage of the cooler elements, move your fridge away

- from open flames or heat sources and ventilate the room where the appliance is located for a few minutes.
- Never use the door handles for lifting.
 - The appliance is heavy and could cause injury, it must be transported by two people.

DISPOSAL OF OLD APPLIANCE:

- Old fridges and fridges contain isolation material and refrigerant with CFC. Therefore, take care not to harm environment when you are discarding your old fridges.
- If your old fridge or fridge has a lock, break or remove the lock before discarding it, because children may get trapped inside it and may cause an accident.
- Be careful to avoid damaging the pipework before disposal, e.g. by puncturing coolant channels, bending pipework, scratching the surface coating.



WARNING: Serious injury or death risk



RISK OF ELECTRIC SHOCK: Dangerous voltage risk



FIRE: Warning; Risk of fire / flammable materials



CAUTION: Injury or property damage risk



IMPORTANT: Operating the system correctly



Symbol ISO 7010 W021

Warning; Risk of fire / flammable materials



ENVIRONMENTAL PROTECTION

Waste electrical products should not be disposed of with household waste. Please recycle where facilities exist. Check with your Local Authority or retailer for recycling advice. This appliance is marked according to the European Directive on Waste Electrical and Electronic Equipment (WEEE).

By ensuring this product is disposed of correctly, you will help prevent potential negative consequences for the environment and human health, which could otherwise be caused by inappropriate waste handling of this product. The symbol on the product indicates that this product may not be treated as household waste. Instead it shall be handed over to the applicable collection point for the recycling of electrical and electronic equipment. Disposal must be carried out in accordance with local environmental regulations for waste disposal.

For more detailed information about treatment, recovery and recycling of this product, please contact your local council, your household waste disposal service or the retailer where you purchased the product.

CE DECLARATIONS OF CONFORMITY

This appliance has been manufactured to the strictest standards and complies with all applicable legislation, Low Voltage Directive (LVD) and Electromagnetic Compatibility (EMC).

UKCA DECLARATIONS OF CONFORMITY

This appliance has been manufactured to the strictest standards and complies with all applicable legislation.

TECHNICAL FICHE

This appliance conforms to all current and applicable energy regulations. To view the Technical Fiche that supports the energy labelling data, please visit the product page on our website www.caple.co.uk

WARRANTY

Your new appliance is covered by warranty. The warranty card is enclosed - if it is missing, you must provide the following information to your retailer in order to receive a replacement: date of purchase, model and serial number (placed on the inside of the appliance storage drawer). Registration can also be completed online by visiting www.caple.co.uk.

Ensure you keep your warranty card safe, you may need to show it to Caple Service together with proof of purchase.

If you fail to show your warranty card you will incur all repair charges.

Spare parts are only available from Caple Service and spare parts authorised centres.

ELECTRICAL CONNECTION

For your safety please read the following information



WARNING:

This appliance must be earthed.

This appliance operates from 220-240 volts and should be protected by a 13 amp fuse in the plug.



IMPORTANT

Do not use the appliance without the fuse cover in position.

The appliance is supplied with a standard 13 amp 3-pin mains plug fitted with a 13-amp fuse. Should the fuse require replacement, it must be replaced with a fuse rated at 13 amp and approved to BS1362.

The mains lead of this appliance has been fitted with a BS 1363A 13A fused plug. To change a fuse in this type of plug, follow the steps below:

1. Remove the fuse cover and fuse.
2. Fit replacement 13A fuse, ASTA approved to BS 1362 type, into the fuse cover.
3. Replace fuse cover.

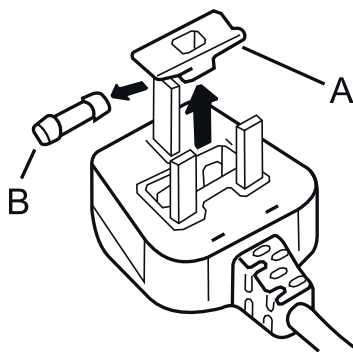

VENTILATION REQUIREMENTS

The main consideration when installing a refrigeration product into a cabinet is ventilation. The heat removed from the appliance needs to be dissipated into the room. Failure to correctly ventilate the product can result in increased running costs and premature failure. It will also invalidate the guarantee provided with the appliance.

An air intake in the plinth is required to allow for the correct air flow (recommended 500mm x 40mm). If preferred a decorative stainless steel plinth grille is available, product code: GRILL/ SENSE600.

This can be purchased from your retailer or www.caple.co.uk.

To ensure the correct operation of the appliance it is important the top of the housing is not blocked off. The top of the cabinet needs to be vented into the room, the recommended minimum size of the vent opening is 500 x 40mm.

There should also be space at the rear of the cabinet to allow the cool air to be drawn over the condenser. This should also be at least 500mm x 40mm. The more air available to circulate the product, the more efficiently it will operate.

NOTE:

Installation instructions are supplied with the appliance in a separate document. Only the solid metal fixing bracket is included (part 1a) for installation.

Due to different kitchen door styles, thicknesses and materials, ensure you check the suitability of the universal screws provided in the fixing kits, and where required source alternative screws.

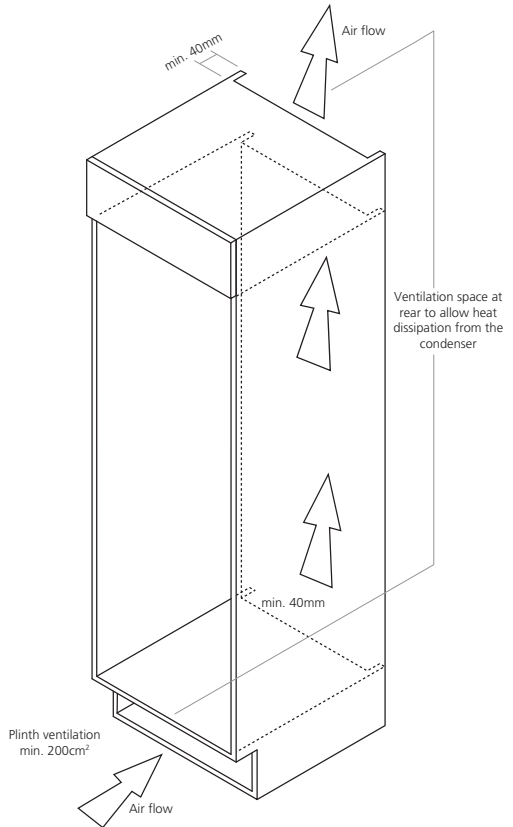

PRODUCT OVERVIEW

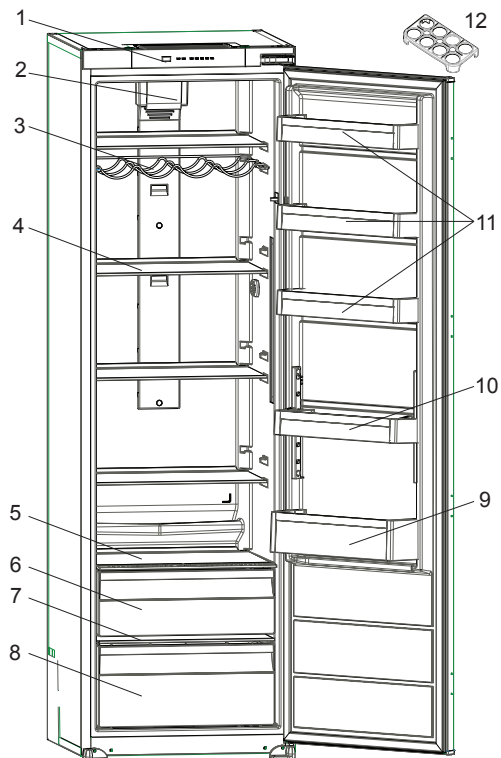

- | | |
|------------------------|--------------------------------|
| 1. Control panel | 7. Crisper cover |
| 2. Turbo fan | 8. Crisper |
| 3. Wine rack | 9. Bottle shelf |
| 4. Fridge shelves | 10. Easy adjustable door shelf |
| 5. Upper crisper cover | 11. Door shelves |
| 6. Upper crisper | 12. Egg holder |



This presentation is only for information about the parts of the appliance. Parts may vary according to the appliance model.

USING THE APPLIANCE

- › Before using your fridge, wipe all parts with a solution of warm water and a teaspoon of sodium bicarbonate. Then, rinse with clean water and dry. Return all parts to the fridge after cleaning.
- › Remove all transport tapes and foam protection pieces. Clean the interior with a cloth dampened in lukewarm soap and water. Rinse with clean water and dry.
- › The adjustable front legs should be stabilised at an appropriate height to allow your fridge to operate in a stable and proper way. You can adjust the legs by turning them clockwise (or in the opposite direction). This should be done before placing food in the fridge.
- › Install the distance adjustment plastic (the part with black vanes at the rear) by turning it 90° as shown in the figure to prevent the condenser from touching the wall.
- › Your fridge may have an odour when it is operated for the first time. This is normal and the odour will fade when your fridge starts to cool.

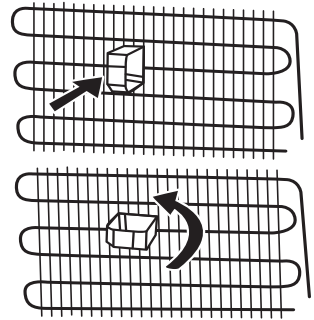

WARNING:

Connect to the electrical socket but do not switch the power to the refrigerator on for at least 12 hours. The coolant within the product needs time to settle after it has been transported and put into position, failure to do this will affect the cooling performance of your appliance.

DISPLAY AND CONTROL PANEL

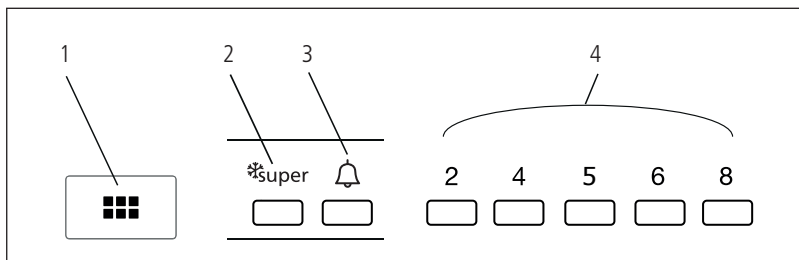

1. Temperature set button
2. Super cooling mode LED
3. Alarm indicator LED
4. Temperature setting indicator

OPERATING YOUR FRIDGE

TEMPERATURE SET BUTTON

This button allows you to change and set the temperature of the fridge. In order to set the temperature of the fridge, press this button until the desired temperature setting is selected. Use this button also to activate Super Cool mode.

TEMPERATURE SETTINGS

- › The initial temperature of the setting display is 5°C.
- › Press the temperature set button once.
- › Every time you press the button, the set temperature will increase.
- › If you press temperature set button until the Super Cool symbol is displayed on the display and you do not press any button within the following 3 seconds, the Super Cool LED will blink.
- › If you keep on pressing the button, it will restart from the last value.

SUPER COOLING MODE - WHEN WOULD IT BE USED?

- › To cool large quantities of food.
- › To cool fresh food.
- › To cool food quickly.
- › To store seasonal food for a long time.

HOW TO USE?

- › Press temperature set button until super cooling light comes on.
- › Super cooling LED will light during this mode.
- › For optimal appliance performance in maximum cooling capacity, set the appliance to active Super Cooling mode 6 hours before you put the fresh food into the fridge.
- ›  During this mode if you press the temperature set button, the mode will be cancelled and the setting will be restore back to '2'. Super cooling mode will be automatically cancelled after 6 hours or when the cooline sensor temperature falls below 2°C.

ALARM LIGHT

- › In case of a problem within the fridge, the alarm LED will illuminate red.

TEMPERATURE ADJUSTMENT WARNINGS

- › It is not recommended that you operate your fridge in environments colder than 10°C in terms of its efficiency.
- › Do not start another adjustment while you are already making an adjustment.
- › Temperature adjustments should be made according to the frequency of door openings, the quantity of food kept inside the fridge and the ambient temperature in the location of your fridge.
- › In order to allow your fridge to reach the operating temperature after being connected to mains, do not open the doors frequently or place large quantities of food in the fridge. Please note that, depending on the ambient temperature, it may take 24 hours for your fridge to reach the operating temperature.
- › A 5 minute delay function is applied to prevent damage to the compressor of your fridge when connecting or disconnecting to mains, or when an energy breakdown occurs. Your fridge will begin to operate normally after 5 minutes.
- › Your appliance is designed to operate in the ambient temperature range T/SN = 10°C -43°C intervals stated in the standards, according to the climate class displayed on the information label. We do not recommend operating your appliance out of the stated temperature limits in terms of cooling effectiveness.

CLIMATE CLASS	AMBIENT TEMPERATURE °C
T	Between 16 and 43 (°C)
ST	Between 16 and 38 (°C)
N	Between 16 and 32 (°C)
SN	Between 16 and 32 (°C)

THE TURBO FAN

- › Do not block the air inlet and outlet openings when storing food, otherwise air circulation provided by the turbo fan will be impaired.

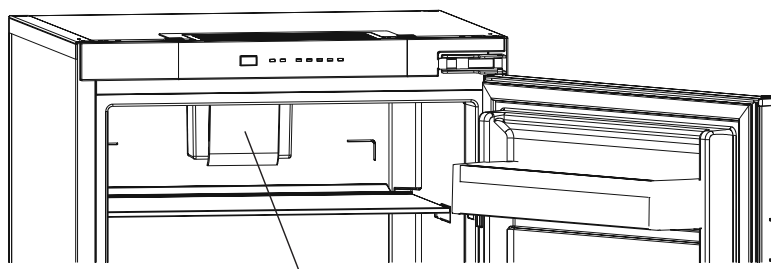

Turbo fan

HUMIDITY CONTROLLED DRAWER

When the humidity controller is in the closed position, it allows fresh fruit and vegetables to be stored longer.

When the drawer is totally full, the humidity controller should be opened. By means of this the air in the draw and humidity rate will be controlled and endurance life will be increased. If you see any condensation on the glass shelf above, the humidity control should be moved into the open position.

NOTE:

The drawers are specifically designed to store fruit & vegetables only. We do not recommend storing meats and/or fish in these drawers.

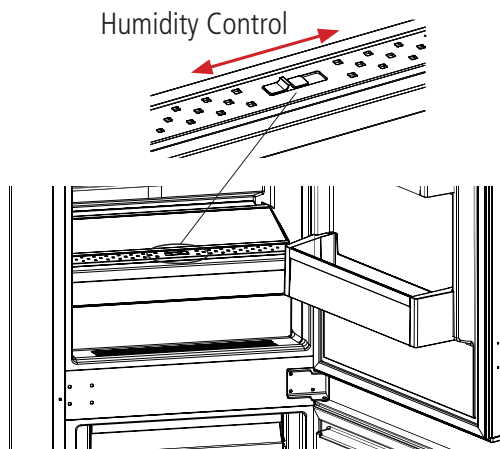

EASY ADJUSTABLE DOOR SHELF

One door shelf is adjustable (the rest are fixed). To adjust the shelf to the appropriate height, hold the bottom of the shelf and pull on the button on each end to unlock as shown in below. Whilst pulled down move the door shelf to the appropriate height (there are 6 height positions). Once set at the correct height, release the buttons to lock it into position.

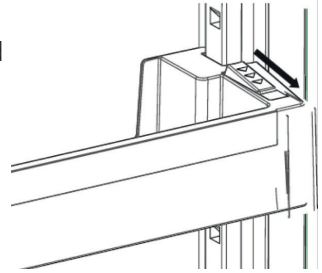

NOTE:

Please ensure the shelf is empty before adjusting.

CAPLE FRESH

MAXI-FRESH PRESERVER

Caple Fresh technology eliminates the ethylene gas (a by-product of fresh foods) inside the vegetable draw. By this method, it maximises the fresh foods shelf life, especially green vegetables. Caple Fresh also blocks the bad smells produced in the refrigerator.

- › The Caple Fresh filter must be cleaned once a year. It can be cleaned by leaving in sunlight for one day.
- › When you want to clean the filter, remove the back side in the direction of the arrow.
- › Don't wet this part with water or detergent.

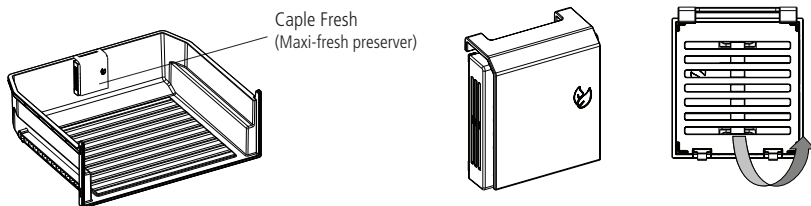

FOOD STORAGE

- › To reduce humidity and avoid the consequent formation of frost, always store liquids in sealed containers in the refrigerator. Frost tends to concentrate in the coldest parts of the evaporating liquid and, in time, your appliance will require more frequent defrosting.
- › Never place warm food in the refrigerator. Warm food should be allowed to cool at room temperature and should be arranged to ensure adequate air circulation in the refrigerator compartment.
- › Make sure no items are in direct contact with the rear wall of the appliance as frost will develop and packaging will stick to it. Do not open the refrigerator door frequently.
- › We recommend that meat and clean fish are loosely wrapped and stored on the glass shelf just above the vegetable bin where the air is cooler, as this provides the best storage conditions.
- › Store loose fruit and vegetable items in the crisper containers.
- › Storing fruit and vegetables separately helps prevent ethylene-sensitive vegetables (green leaves, broccoli, carrot, etc.) being affected by ethylene-releaser fruits (banana, peach, apricot, etc.).
- › Do not put wet vegetables into the refrigerator.
- › Storage time for all food products depends on the initial quality of the food and an uninterrupted refrigeration cycle before refrigerator storage.
- › To avoid cross-contamination do not store meat products with fruit and vegetables. Water leaking from meat may contaminate other products in the refrigerator. You should package meat products and clean any leakages on the shelves.
Do not put food in front of the air flow passage.
- › Consume packaged foods before the recommended expiry date.



NOTE:

Potatoes, onions and garlic should not be stored in the refrigerator. The table below is a quick guide to show you the most efficient way to store the major food groups in your refrigerator compartment.'

FOOD	MAXIMUM STORAGE TIME	HOW AND WHERE TO STORE
Vegetables and fruit	1 week	Vegetable bin
Meat and fish	2 - 3 days	Wrap in plastic foil bags, or in a meat container and store on the glass shelf
Fresh Cheese	3 - 4 days	On the designated door shelf
Butter and margarine	1 week	On the designated door shelf
Bottles products e.g. milk and yoghurt	Until the expiry date recommended by the producer	On the designated door shelf
Eggs	1 month	On the designated door shelf
Cooked food	2 days	All shelves

CLEANING AND MAINTENANCE



Disconnect the unit from the power supply before cleaning.



Do not wash your appliance by pouring water on it.



Do not use abrasive products, detergents or soaps for cleaning the appliance. After washing, rinse with clean water and dry carefully. When you have finished cleaning, reconnect the plug to the mains supply with dry hands.

- › Make sure that no water enters the lamp housing and other electrical components.
- › The appliance should be cleaned regularly using a solution of bicarbonate of soda and lukewarm water.
- › Clean the accessories separately by hand with soap and water. Do not wash accessories in a dish washer.
- › Clean the condenser with a brush at least twice a year. This will help you to save on energy costs and increase productivity.



NOTE:

The power supply must be disconnected during cleaning.

DEFROSTING THE REFRIGERATOR COMPARTMENT

Defrosting occurs automatically in the refrigerator compartment during operation; the water is collected by the evaporation tray and evaporates automatically.

The evaporation tray and the water drain hole should be cleaned periodically with the defrost drain plug to prevent the water from collecting at the bottom of the refrigerator instead of flowing out.

You can also clean the drain hole by pouring ½ glass of water down it.

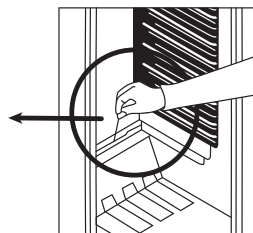
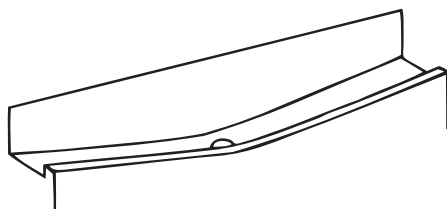

REPLACING LED LIGHTING

LIGHT SOURCE ENERGY CLASS

This product contains light sources of energy efficiency classes E and F.

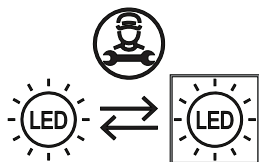

 The LED light must be replaced by an authorised engineer or similar only. For more information, please contact Caple service - 0117 938 7420 or service@caple.co.uk

 Unplug the unit from the power supply before starting the process.

1. Carefully insert a flat screw driver into the edge of the cover and lift cover off.
2. Remove the LED light from its housing.
3. Disconnect the connector and change the LED light.
4. Implement the steps in reverse order.
5. After waiting 5 minutes, plug the unit.

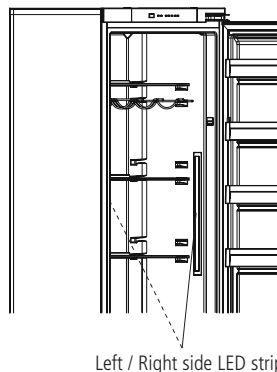
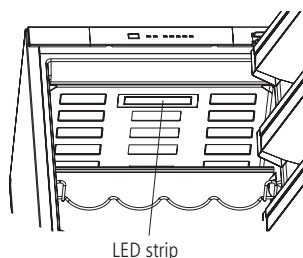

HOLIDAY

SHORT HOLIDAYS: Leave the fridge operating during holidays of less than three weeks.

LONG HOLIDAYS: If the appliance will not be used for several months, remove all items and turn off the appliance. Clean and dry the interior thoroughly. To prevent odour and mould growth, leave the door open slightly (blocking it open if necessary).

TRANSPORT AND REPOSITIONING

TRANSPORTATION AND CHANGING POSITIONING

- › The original packaging and foam may be kept for re-transportation (optional).
- › Fasten your appliance with thick packaging, bands or strong cords and follow the instructions for transportation on the packaging.
- › Remove all movable parts (shelves, accessories, vegetable bins, and so on) or fix them into the appliance against shocks using bands/tape when re-positioning or transporting.
- ›  Always carry your appliance in the upright position.

TROUBLESHOOTING

BEFORE CALLING FOR SERVICE

Reviewing the information below may save you from calling for service.

ALARM INDICATOR LED IS TURNING ON	MEANING	WHY	WHAT TO DO
	Failure Warning	<p>There is/are some part(s) out of order or there is a failure in the cooling process.</p> <p>The product has been plugged in for the first time, or power has been interrupted for more than 1 hour.</p>	<p>Check if the door is open or not. Check the appliance in 1 hour to see if it is now working, and the alarm has turned off. If the door is not open, or the appliance is still not working after 1 hour, call Caple service for assistance.</p>

THE APPLIANCE DOES NOT OPERATE CHECK IF:

- › There is power to the unit
- › The general switch in your home is connected
- › The socket is working. To check this, plug in another appliance that you know is working into the same socket.

THE APPLIANCE PERFORMS POORLY CHECK IF:

- › You have not overloaded the appliance
- › The fridge temperature set to 2
- › The door is closed perfectly
- › There is no dust on the condenser
- › There is enough space at the rear and side walls for ventilation

WHY IS MY FRIDGE OPERATING LOUDLY?

CRACKING (ICE CRACKING):

- › During automatic defrosting.
- › When the appliance is cooled or warmed (due to expansion of appliance material).

SHORT CRACKING:

Heard when the thermostat switches the compressor on/ off.

COMPRESSOR NOISE:

Normal motor noise. This noise means that the compressor operates normally. The compressor may cause more noise for a short time when it is activated.

BUBBLING NOISES:

This noise is caused by the flow of the refrigerant in the tubes of the system.

AIR BLOWING NOISE:

Normal fan noise. This noise can be heard in fridge during normal operation of the system due to the circulation of air.

IF THE DOORS ARE NOT OPENING AND CLOSING PROPERLY

- › Do the food packages prevent closing of the door?
- › Are the door compartments, shelves and drawers placed properly?
- › Are door joints broken or torn?
- › Is your fridge on a level surface?

RECOMMENDATIONS

- › To stop the appliance completely, unplug from main socket (for cleaning and when the door is left open).

If the problem persists or more help is required, please contact our Caple service team on **0117 938 7420** or via email service@caple.co.uk

SPARE PARTS AVAILABILITY

The original spare parts for some specific components are available for a minimum of 7 or 10 years, based on the type of component, from the placing on the market of the last unit of the model.

For more info and to order spares, please contact Caple service or visit our website www.caple.co.uk.

ENERGY SAVING TIPS

1. Install the appliance in a cool, well ventilated room, but not in direct sunlight and not near a heat source (such as a radiator or oven) otherwise an insulating plate should be used.
2. Allow warm food and drinks to cool before placing them inside the appliance.
3. Place thawing food in the refrigerator compartment. The low temperature of the frozen food will help cool the refrigerator compartment while the food is thawing. This will save energy. Frozen food left to thaw outside of the appliance will result in a waste of energy.
4. Drinks or other liquids should be covered when inside the appliance. If left uncovered, the humidity inside the appliance will increase, therefore the appliance uses more energy. Keeping drinks and other liquids covered helps preserve their smell and taste.
5. Avoid keeping the doors open for long periods and opening the doors too frequently as warm air will enter the appliance and cause the compressor to switch on unnecessarily often.
6. Keep the covers of the different temperature compartments (such as the crisper and chiller) closed.
7. The door gasket must be clean and pliable. Replace gaskets if worn.

NOTES



Caple Service
Fourth Way
Avonmouth
Bristol
BS11 8DW

T: 0117 938 1900
E: service@caple.co.uk
www.caple.co.uk