



Premium Built in 50/50 Fridge Freezer Instruction Manual

RI5520



Contact Caple on 0117 938 7420 for spare parts or www.caple.co.uk

CONTENTS

Warnings	3
Environmental Protection	12
Electrical Connection	13
Ventilation Requirements	14
Product Overview	15
Using The Appliance	16
Operating Your Fridge Freezer	19
Accessories	28
Caple Fresh	28
Humidity Controlled Drawer	29
The Turbo Fan	29
Easy Adjustable Door Shelf	30
Freezer Storage	30
Food Storage	31
Cleaning And Maintenance	38
Transport And Repositioning	41
Troubleshooting	42
Energy Saving Tips	46
Caple Contact Details	48

SAFETY INSTRUCTIONS

Read these instructions carefully and completely before using your appliance. They provide you with important information regarding the safe installation, use and maintenance of the appliance as well as useful advice for getting the best out of your fridge freezer. Keep this booklet in a safe place for future reference and pass on to any future owner.

- This appliance is produced in accordance with all applicable local and international standards and regulations.
- This appliance is intended to be used in household and similar applications such as:
 - › Staff kitchen areas in shops, offices and other working environments.
 - › Farm Houses.
 - › By clients in hotels, motels and other residential type environments.
 - › Bed and breakfast type environments.
- This appliance may only be used by persons (including children) with reduced physical, sensory or mental capabilities, or lack of experience and knowledge, if they are supervised whilst using it. They may only use it unsupervised if they have been shown how to use it in a safe manner. They must be able to recognise and understand the dangers of misuse.

SAFETY WITH CHILDREN:

- This appliance can be used by children aged from 8 years and above.
- Children less than 8 years of age should be kept away unless continuously supervised or they have been shown how to use it in a safe manner. Children must be able to understand and recognise the possible dangers caused by incorrect operation.
- Children should be supervised in the vicinity of the appliance.
- Never allow children to play with the appliance.
- Cleaning and user maintenance should not be carried out by children without supervision.
- Children aged from 3 to 8 years are allowed to load and unload refrigerating appliances.
- Materials used for packaging (nylon, staplers, Styrofoam etc.) may cause harmful effects to children, they should be disposed of immediately.
- Children can injure themselves on an open door. Do not let children sit on the open door, lean against it or swing on it.

TECHNICAL SAFETY:

- Maintenance and repair work must be made only by authorised Caple service technicians. Installation and repair work that is carried out by unauthorised technicians may endanger you.

- While the appliance is under warranty, repairs should only be undertaken by a Caple authorised service technician. Otherwise the warranty will be invalidated.
- It is dangerous to alter or modify the specifications of the appliance in any way. The requirements for this appliance are stated on the rating label.
- Risk of injury due to electric shock. Any contact with live connections or tampering with the electrical or mechanical components of the appliance will endanger your safety and may lead to the appliance malfunctioning.
- To maintain the efficiency and safety of your appliance, we recommend you always use original spare parts and to call only our authorised Caple Service agents in case of need.
- Multi-socket adapters and extension leads should not be used to connect the appliance to the mains electricity supply.
- The electrical system of this appliance may be used safely only when it is correctly connected to an efficient earthing system in compliance with the safety standards currently in effect.
- Insert the plug into a socket with an efficient ground connection. If the socket has no ground contact or the plug does not match, we recommend you consult a qualified electrician for assistance.
- The appliance must be connected with a properly installed fused socket. The power supply (AC) and

voltage at the operating point must match with the details on the rating plate of the appliance.

- Consult a qualified electrician or service person if the Grounding instructions are not completely understood, or if you have doubts on whether the appliance is properly grounded.
- The incorrect grounding may cause breakdown and electric shock.
- We do not accept responsibility for any damages that occur due to ungrounded usage.
- If the socket does not match the refrigerator plug, it must be replaced by the manufacturer, a service agent or similarly qualified persons in order to avoid a hazard.
- A specially grounded plug has been connected to the power cable of your refrigerator. This plug should be used with a specially grounded socket of 13 amperes. If there is no such socket in your house, please have one installed by an authorised electrician.

INSTALLATION WARNINGS:

- Prior to installation, ensure that the local distribution conditions (electricity voltage and frequency) and the requirements of the appliance are compatible.
- During installation the appliance must be completely disconnected from the mains electricity supply.
- Do not operate the appliance before it is fully installed.

- The appliance must be installed by an authorised technician.
-  **WARNING:** In order to avoid any hazards resulting from the instability of the appliance, it must be fixed in accordance with the following instructions.
- This appliance is not intended for use at altitudes exceeding 2000m.
- Your appliance must be at least 50 cm away from stoves, gas ovens and heater cores, and at least 5 cm away from electrical ovens.
- If your fridge freezer is placed next to a deep freezer, there must be at least 2cm between them to prevent humidity forming on the outer surface.
- Do not cover the body or top of fridge freezer with lace. This will affect the performance of your fridge freezer.
- Clearance of at least 150 mm is required at the top of your appliance. Do not place anything on top of your appliance.
- Caple is not responsible for any damage that may be caused by defective placement and installation by unauthorised persons.
- When unpacking the appliance, make sure that it is not damaged during transportation.
- Check the appliance for any damage.
- In the case of any defect; do not use the appliance and contact your retailer or Caple Service immediately.

- **⚠ WARNING:** When positioning the appliance, ensure the supply cord is not trapped or damaged. If the supply cord is damaged, it must be replaced by a Caple service technician or similarly qualified persons in order to prevent a hazard.
- Never touch the power cord/plug with wet hands. This may cause a short circuit or electric shock.
- The plug must be accessible after installation.
- **⚠ WARNING:** Do not locate multiple portable socket-outlets or portable power supplies at the rear of the appliance.
- Protect your appliance against atmospheric effects. Do not expose it to effects such as sun, rain, snow etc.

DURING USE:



- Do not store explosive substances such as aerosol cans with a flammable propellant in this appliance.
- Place drinks with high alcohol content vertically in the fridge compartment and make sure their tops are tightly closed.
- If you know you will not be using the appliance for a while switch it off from the main supply and unplug it.
- **⚠ WARNING:** Keep ventilation openings, in the appliance enclosure or in the built-in structure, clear of obstruction.
- Do not place your appliance on a carpeted surface as this will prevent adequate ventilation.

- When the appliance is not in use, we recommend you turn it off, and isolate it from the electrical supply.
- This appliance must be used in the vertical position on a flat surface.
- **⚠ WARNING:** Do not use electrical appliances inside the food storage compartments of the appliance, unless they are of the type recommended by the manufacturer.
- The manufacturer will not be held liable for any damages that might arise out of incorrect or improper use of the appliance.
- Do not touch frozen goods with wet hands. Your hands may freeze to the frozen food.
- Do not eat ice-cream or ice cubes immediately after they are removed from the freezer compartment. Frozen food can cause frost burn to the lips and tongue.
- Do not re-freeze partially or fully thawed food. This may cause health issues such as food poisoning. Defrosted food may only be re-frozen after it has been cooked.
- Do not place glass bottles or cans containing carbonated drinks in the freezer compartment as they will burst when the contents freezes.
- If using the appliance to quickly cool drinks, do not leave bottles inside the freezer compartment for more than 1 hour, otherwise they could burst.

CLEANING AND MAINTENANCE:

- Clean the appliance thoroughly before use.
- Always switch off the appliance from the mains isolating the electrical supply before any cleaning or maintenance.
-  **WARNING:** Do not use mechanical devices or other means to accelerate the defrosting process, other than those recommended by the manufacturer.

TRANSPORT:

-  **WARNING:** Do not damage the refrigerant circuit.
- Always transport the appliance in its original packaging and in an upright position.
-  If your appliance uses R600a as a refrigerant, you should take care during transportation and installation to prevent the cooler elements from being damaged. R600a is an environmentally friendly and natural gas, but it is explosive. In the event of a leak due to damage of the cooler elements, move your fridge away from open flames or heat sources and ventilate the room where the appliance is located for a few minutes.
- Never use the door handles for lifting.
- The appliance is heavy and could cause injury, it must be transported by two people.

DISPOSAL OF OLD APPLIANCE:

- Old fridges and freezers contain isolation material and refrigerant with CFC. Therefore, take care not to harm environment when you are discarding your old fridges.
- If your old fridge or freezer has a lock, break or remove the lock before discarding it, because children may get trapped inside it and may cause an accident.
- Be careful to avoid damaging the pipework before disposal, e.g. by puncturing coolant channels, bending pipework, scratching the surface coating.



WARNING:

Serious injury or death risk



RISK OF ELECTRIC SHOCK:

Dangerous voltage risk



FIRE

Warning; Risk of fire / flammable materials



CAUTION

Injury or property damage risk



IMPORTANT:

Operating the system correctly



Symbol ISO 7010 W021

Warning; Risk of fire / flammable materials



ENVIRONMENTAL PROTECTION

Waste electrical products should not be disposed of with household waste. Please recycle where facilities exist. Check with your Local Authority or retailer for recycling advice. This appliance is marked according to the European Directive on Waste Electrical and Electronic Equipment (WEEE).

By ensuring this product is disposed of correctly, you will help prevent potential negative consequences for the environment and human health, which could otherwise be caused by inappropriate waste handling of this product. The symbol on the product indicates that this product may not be treated as household waste. Instead it shall be handed over to the applicable collection point for the recycling of electrical and electronic equipment. Disposal must be carried out in accordance with local environmental regulations for waste disposal.

For more detailed information about treatment, recovery and recycling of this product, please contact your local council, your household waste disposal service or the retailer where you purchased the product.

CE DECLARATIONS OF CONFORMITY **CE**

This appliance has been manufactured to the strictest standards and complies with all applicable legislation, Low Voltage Directive (LVD) and Electromagnetic Compatibility (EMC).

UKCA DECLARATIONS OF CONFORMITY **UK CA**

This appliance has been manufactured to the strictest standards and complies with all applicable legislation.

TECHNICAL FICHE

This appliance conforms to all current and applicable energy regulations. To view the Technical Fiche that supports the energy labelling data, please visit the product page on our website www.caple.co.uk

WARRANTY

Your new appliance is covered by warranty. The warranty card is enclosed - if it is missing, you must provide the following information to your retailer in order to receive a replacement: date of purchase, model and serial number (placed on the inside of the appliance storage drawer). Registration can also be completed online by visiting www.caple.co.uk.

Ensure you keep your warranty card safe, you may need to show it to Caple Service together with proof of purchase.

If you fail to show your warranty card you will incur all repair charges.

Spare parts are only available from Caple Service and spare parts authorised centres.

ELECTRICAL CONNECTION

For your safety please read the following information



WARNING:

This appliance must be earthed.

This appliance operates from 220-240 volts and should be protected by a 13 amp fuse in the plug.



IMPORTANT

Do not use the appliance without the fuse cover in position.

The appliance is supplied with a standard 13 amp 3-pin mains plug fitted with a 13-amp fuse. Should the fuse require replacement, it must be replaced with a fuse rated at 13 amp and approved to BS1362.

The mains lead of this appliance has been fitted with a BS 1363A 13A fused plug. To change a fuse in this type of plug, follow the steps below:

1. Remove the fuse cover and fuse.
2. Fit replacement 13A fuse, ASTA approved to BS 1362 type, into the fuse cover.
3. Replace fuse cover.

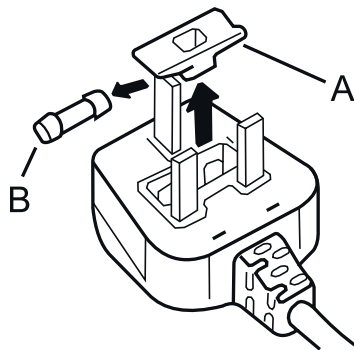

VENTILATION REQUIREMENTS

The main consideration when installing a refrigeration product into a cabinet is ventilation. The heat removed from the appliance needs to be dissipated into the room. Failure to correctly ventilate the product can result in increased running costs and premature failure. It will also invalidate the guarantee provided with the appliance.

An air intake in the plinth is required to allow for the correct air flow (recommended 500mm x 40mm). If preferred a decorative stainless steel plinth grille is available, product code: GRILL/ SENSE600. This can be purchased from your retailer or www.caple.co.uk.

To ensure the correct operation of the appliance it is important the top of the housing is not blocked off. The top of the cabinet needs to be vented into the room, the recommended minimum size of the vent opening is 500 x 40mm.

There should also be space at the rear of the cabinet to allow the cool air to be drawn over the condenser. This should also be at least 540mm x 40mm. The more air available to circulate the product, the more efficiently it will operate.

NOTE:

Installation instructions are supplied with the appliance in a separate document. Only the solid metal fixing bracket is included (part 1a) for installation.

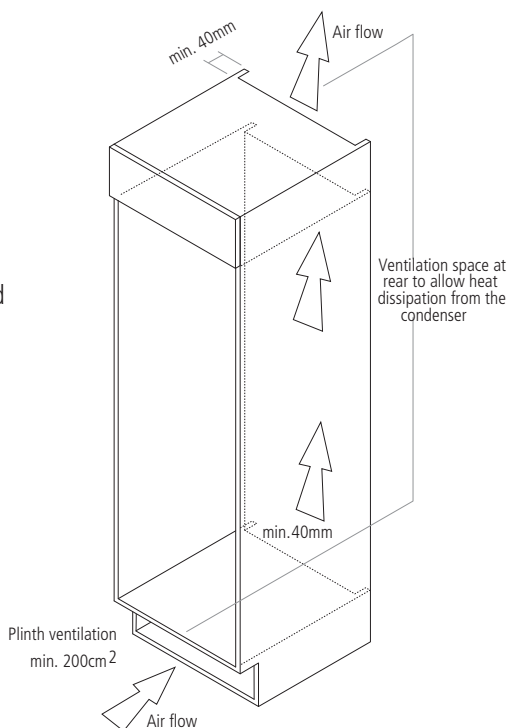

PRODUCT OVERVIEW

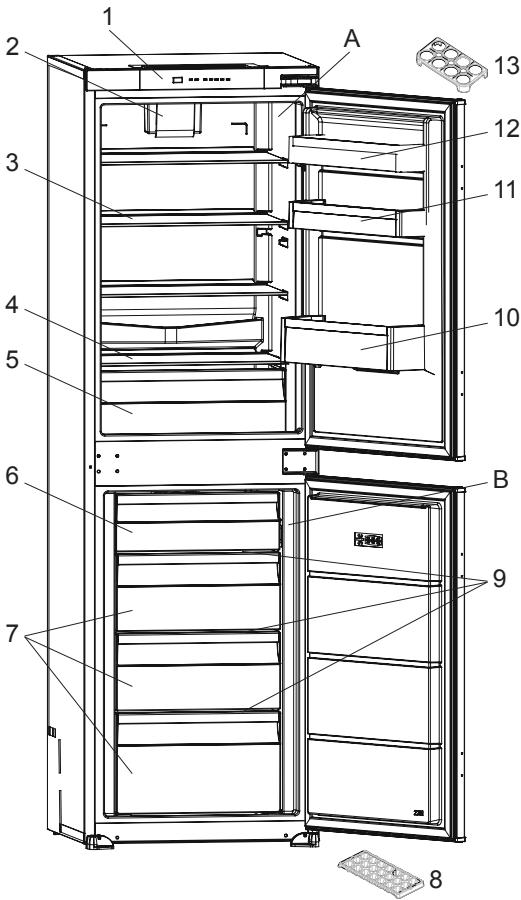

A) Refrigerator compartment

B) Freezer compartment

1) Control panel

2) Turbo fan

3) Refrigerator shelves

4) Crisper cover

5) Crisper

6) Sliding tray

7) Freezer drawers

8) Ice box tray

9) Freezer glass shelves

10) Bottle shelf

11) Adjustable door shelf

12) Door shelf

13) Egg tray



This presentation is only for information about the parts of the appliance.
Parts may vary according to the appliance model

USING THE APPLIANCE

- › Before using your appliance, wipe all parts with a solution of warm water and a teaspoon of sodium bicarbonate. Then, rinse with clean water and dry. Return all parts to the appliance after cleaning.
- › Remove all transport tapes and foam protection pieces. Clean the interior with a cloth dampened in lukewarm soap and water. Rinse with clean water and dry.
- › Your appliance may have an odour when it is operated for the first time. This is normal and the odour will fade when your fridge starts to cool.
- › When the appliance has been positioned, adjust the feet to ensure the unit is stable. This is essential to ensure quiet running and proper door opening/closing.

WARNING:

Connect to the electrical socket but do not switch the power to the appliance on for at least 12 hours. The coolant within the product needs time to settle after it has been transported and put into position, failure to do this will affect the cooling performance of your appliance.

FROST FREE TECHNOLOGY

Frost Free refrigerators have a different operating system to static refrigerators.

In normal (static) fridges, the humidity entering the fridge due to opening the door, and the humidity inherent in the food, causes frost build-up in the freezer compartment.

To defrost the frost and ice in the freezer compartment, you are required to periodically switch off the fridge, place the frozen food in a separate cooled container, then remove the ice gathered in the freezer compartment. The situation is completely different in Frost free fridges.

A built-in fan blows dry and cold air evenly throughout the cooler and freezer compartments. The cold air disperses uniformly between the shelves, ensuring all your food is cooled equally, thus preventing humidity and frost build-up. Therefore, your Frost free fridge allows ease of use, in addition to its huge capacity and stylish appearance.

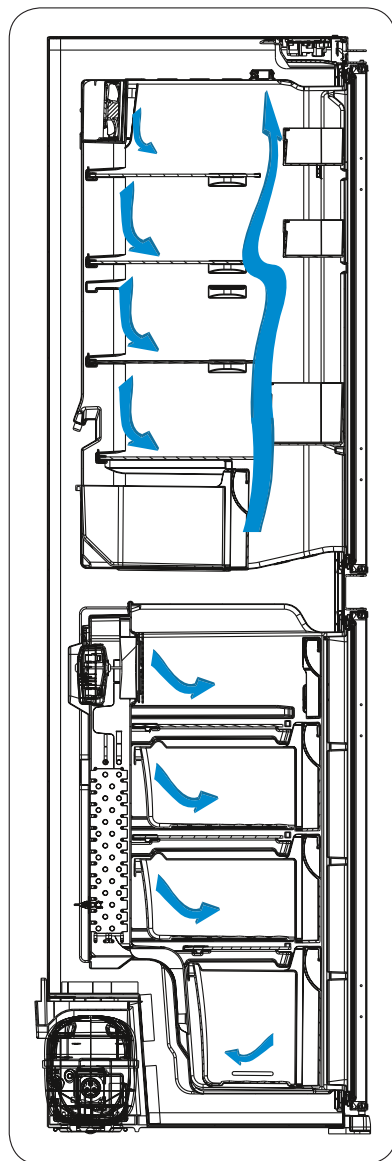

DISPLAY AND CONTROL PANEL

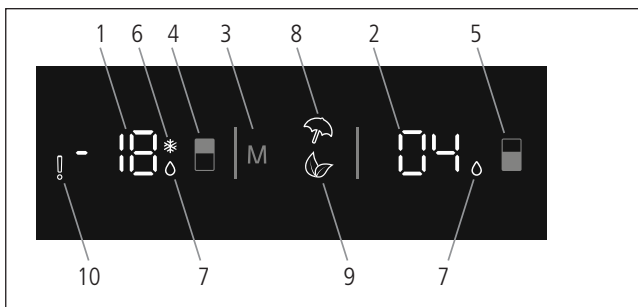

1. Freezer temperature setting.
2. Fridge temperature setting.
3. Mode Button. Enables the Economy and Holiday modes to be activated if desired.
4. Freezer Temperature Set Button. Set to -16, -18, -20, -22, -24°C and Super Freeze.
5. Fridge Temperature Set Button. Set to 8, 6, 5, 4, 2°C and Super Cool.
6. Super Freeze mode Indicator.
7. Super Cool mode Indicator.
8. Holiday mode Indicator.
9. Eco mode Indicator.
10. Alarm Indicator. Lights when there is an error with the appliance (see Troubleshooting Section).

OPERATING YOUR FRIDGE FREEZER



When the product is plugged in for the first time, the interior lights may turn on 1 minute late due to opening tests.

SUPER COOL MODE

PURPOSE:

- › To cool and store a large quantity of food in the fridge compartment.
- › To quickly cool drinks.

HOW TO USE:

- › Press the Fridge set button until Super Cool symbol can be seen on the screen. The buzzer will sound. Mode will be set.

DURING THIS MODE:

Super Cool mode can be cancelled by the same operation of selecting.

- › Temperature of freezer and Super Freeze mode may be adjusted. In this case Super Cool mode continues.
- › Economy and Holiday mode can not be selected.
- › Super Cool mode can be cancelled by the same operation of selecting.

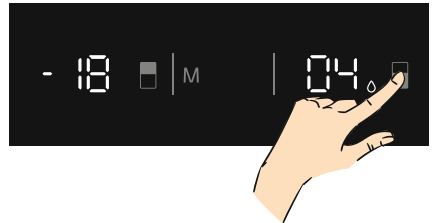

SUPER FREEZE MODE

PURPOSE:

- › To freeze a large quantity of food that cannot fit on the fast freeze shelf.
- › To freeze prepared foods.
- › To freeze food quickly to retain freshness.

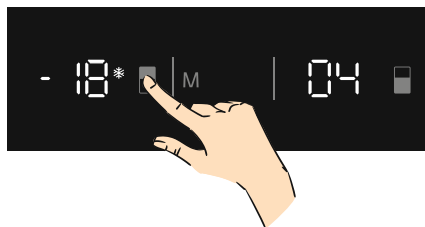

HOW TO USE:

- › Press the freezer set button until the Super Freeze symbol can be seen on the screen. The buzzer will sound. Mode will be set.

DURING THIS MODE:

- › Temperature of fridge and Super Cool mode may be adjusted. In this case Super Freeze mode continues.
- › Economy and Holiday mode can not be selected.
- › Super Freeze mode can be cancelled by the same operation of selecting.

NOTE:

The maximum amount of fresh food (in kilograms) that can be frozen within 24 hours is shown on the appliance label.

For optimal appliance performance in maximum freezer capacity, activate Super Freeze mode 24 hours before you put fresh food into the freezer.



Super Freeze mode will automatically cancel after 54 hours, depending on the environmental temperature or when the freezer sensor reaches a sufficiently low temperature.

ECONOMY MODE

PURPOSE:

- › Energy saving. During periods of less frequent use (door opening) or absence from home, such as a holiday, Economy Mode can provide optimum temperature whilst saving power.

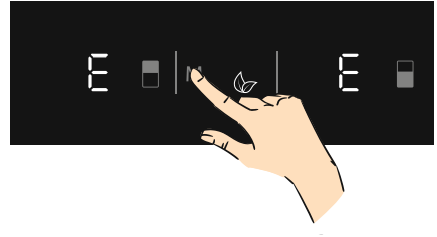

HOW TO USE:

- › Push the "mode" button until the 'eco' symbol appears.
- › Eco symbol will blink 3 times. When mode is set, the buzzer will sound.
- › Fridge and Freezer temperature segments will show "E".
- › Economy symbol and E will light till mode finishes.

DURING THIS MODE:

- › Fridge and Freezer may be adjusted. When Economy mode is cancelled, the selected setting values will proceed.
- › Super Cool and Super Freeze mode can be selected. Economy mode is automatically cancelled and the selected mode is activated.
- › Holiday mode can be selected after cancelling the Economy mode. Then the selected mode is activated.
- › To cancel, press the "mode" button.

HOLIDAY MODE

HOW TO USE:

- › Push “mode” button until holiday symbol appears.
- › Holiday symbol will blink 3 times. When mode is set, the buzzer will sound.
- › Fridge temperature segment will show “--”.
- › Holiday symbol and “--” will light till mode finishes.

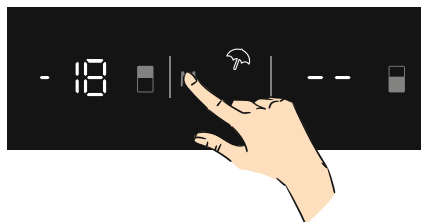

DURING THIS MODE:

- › Freezer may be adjusted. When Holiday mode is cancelled, the selected setting values will proceed.
- › Fridge may be adjusted. When Holiday mode is cancelled, the selected setting values will proceed.
- › Super Cool and Super Freeze modes can be selected. Holiday mode is automatically cancelled and the selected mode is activated.
- › Economy mode can be selected after cancelling the Holiday mode. Then the selected mode is activated.
- › To cancel, you will just need to press the “mode” button.

DRINK COOL MODE

PURPOSE:

- › This mode is used to cool drinks within an adjustable time. After the selected period of time an alarm will sound.

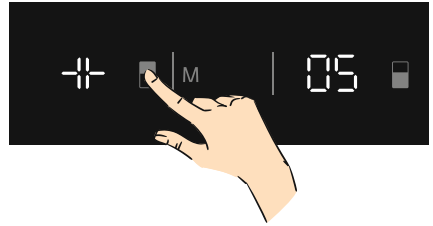

HOW TO USE:

- › Press and hold Freezer Set Button for 3 seconds.
- › Special animation will show on the freezer set value screen and '05' will blink on fridge set value screen.
- › Press the Fridge Set Button to adjust the time (05 - 10 - 15 - 20 -25 - 30 minutes).
- › When you select the time the numbers will blink 3 times on screen and a beep will sound.
- › If no button is pressed within 2 seconds the time will be set.
- › The countdown starts from the adjusted time minute by minute.
- › Remaining time will blink on the screen.
- › To cancel this mode press the freezer set button for 3 seconds.

SCREEN SAVER MODE

PURPOSE:

- › This mode saves energy by switching off all control panel lighting when the panel is left inactive.

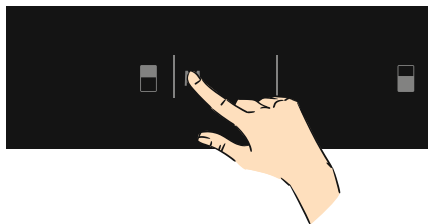

HOW TO USE:

- › Screen Saver Mode is default to Active when you use the appliance for the first time.
- › If no button is pressed within 30 seconds, when the mode is active, the lights of the control panel will go Off.
- › If you press any button when the lights of the control panel are Off, the current settings will appear on the screen; adjustments can then be made. If you neither cancel Screen Saver mode nor press on any button for 30 seconds the control panel will turn Off again.
- › To cancel Screen Saver mode, press the "Mode" button for 3 seconds.
- › To reactivate this mode, press on the "Mode" button for 3 seconds.

FRIDGE TEMPERATURE SETTINGS

- › The initial temperature value for the fridge is 4°C.
- › Press the fridge set button once.
- › When you first push this button, the last set value will appear on the setting indicator.
- › Whenever you press this button, a lower temperature will be set (8°C, 6°C, 5°C, 4°C, 2°C, Super Cool).
- › When you push the "Temperature Set" button until the Super Cool symbol appears, and you do not push any other button within 1 second, Super Cool will flash.
- › If you continue to press it, it will restart from 8°C.
- › The temperature value selected before Super Cool Mode or Economy mode is activated will remain the same when the mode is over or cancelled. The appliance continues to operate with this temperature value.

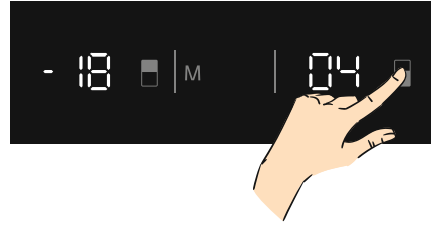

FREEZER TEMPERATURE SETTINGS

- › The initial temperature value for the freezer is -18°C.
- › Press the freezer set button once.
- › When you first push this button, the last set value will appear on the freezer setting indicator.
- › Whenever you press this button, a lower temperature will be set (-16 °C, -18 °C, -20 °C, -22 °C, -24 °C, Super Freeze).
- › When you push the freezer set button until the Super Freeze symbol appears, and you do not push any other button within 1 second, Super Freeze will flash.
- › If you continue to press it, it will restart from -16 °C.
- › The temperature value selected before Holiday Mode, Super Freeze Mode, Super Cool Mode or Economy mode is activated will remain the same when the mode is over or cancelled. The appliance continues to operate with this temperature value.

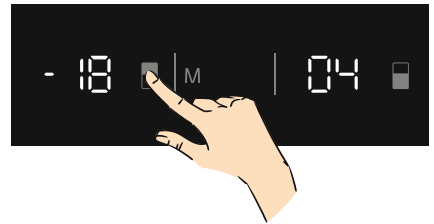

STAND-BY MODE

PURPOSE:

- › This mode can be used to save energy when you go on holiday.

HOW TO USE:

- › Select "8" set value.
- › Push the "mode" and Fridge Temperature set button for 5 seconds.
- › The display will show "St" "bY" on the screen.

DURING THIS MODE:

- › All components will be disabled.
- › If you push the display button, display will show "St" "bY" on the screen to show stand-by mode is active.
- › To cancel, push the mode and cooler set button for 5 seconds.

NOTE:

After this mode is deactivated, an error code may light on the display because the product may not be cool enough. The error code will turn off when the product reaches normal temperature.

DOOR OPEN ALARM

- › If the fridge or freezer door is left open for more than 2 minutes, an audible alarm will sound. Close the door.

TEMPERATURE ADJUSTMENT WARNINGS

- › Your temperature adjustments will not be deleted when an energy breakdown occurs.
- › It is not recommended that you operate your appliance in environments colder than 10°C in terms of its efficiency.
- › Do not start another adjustment while you are already making an adjustment.
- › Temperature adjustments should be made according to the frequency of door openings, the quantity of food kept inside the fridge freezer and the ambient temperature in the location of your appliance.
- › In order to allow your appliance to reach the operating temperature after being connected to mains, do not open the doors frequently or place large quantities of food in the freezer. Please note that, depending on the ambient temperature, it may take 24 hours for your appliance to reach the operating temperature.
- › A 5 minute delay function is applied to prevent damage to the compressor of your appliance when connecting or disconnecting to mains, or when an energy breakdown occurs. Your appliance will begin to operate normally after 5 minutes.
- › Your appliance is designed to operate in the ambient temperature intervals stated in the standards, according to the climate class stated on the rating label. We do not recommend operating your appliance out of stated temperatures value limits in terms of cooling effectiveness.
- › This appliance is designed for use at an ambient temperature within the 16°C - 43°C range.

CLIMATE CLASS	AMBIENT TEMPERATURE °C
T	Between 16 and 43 (°C)
ST	Between 16 and 38 (°C)
N	Between 16 and 32 (°C)
SN	Between 10 and 32 (°C)

ACCESSORIES

ICE TRAY

- › Fill the ice tray with water and place in the freezer compartment.
- › After the water has completely frozen, you can twist the tray as shown below to remove the ice cubes.



CAPLE FRESH

(MAXI-FRESH PRESERVER)

- › Caple-Fresh technology eliminates the ethylene gas (a by-product of fresh foods) inside the vegetable draw. By this method, it maximises the fresh foods shelf life, especially green vegetables. Caple Fresh also blocks the bad smells produced in the refrigerator.
- › The Caple Fresh filter must be cleaned once a year. It can be cleaned by leaving in sunlight for one day.
- › When you want to clean the filter, remove the back side in the direction of the arrow.
- › Don't wet this part with water or detergent.

Caple Fresh
(Maxi-fresh preserver)

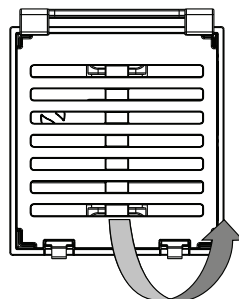
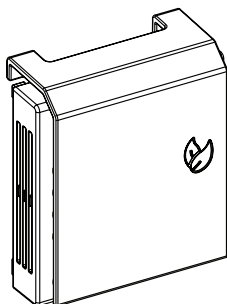
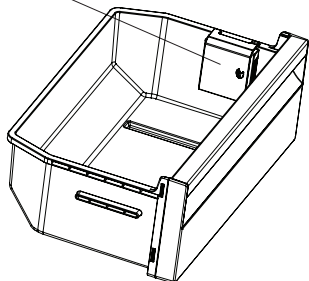

HUMIDITY CONTROLLED DRAWER

When the humidity controller is in the closed position, it allows fresh fruit and vegetables to be stored longer.

When the drawer is totally full, the humidity controller should be opened. By means of this the air in the draw and humidity rate will be controlled and endurance life will be increased. If you see any condensation on the glass shelf above, the humidity control should be moved into the open position.

NOTE:

The drawers are specifically designed to store fruit & vegetables only. We do not recommend storing meats and/or fish in these drawers.

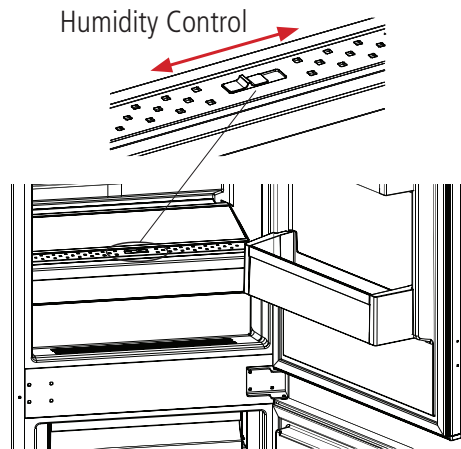

THE TURBO FAN

- › Do not block the air inlet and outlet openings when storing food, otherwise air circulation provided by the turbo fan will be impaired.

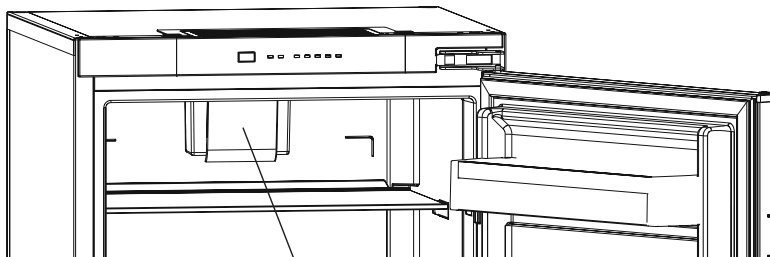

Turbo fan

EASY ADJUSTABLE DOOR SHELF

One door shelf is adjustable (the rest are fixed). To adjust the shelf to the appropriate height, hold the bottom of the shelf and pull on the button on each end to unlock as shown in below. Whilst pulled down move the door shelf to the appropriate height (there are 6 height positions). Once set at the correct height, release the buttons to lock it into position.



NOTE:

Please ensure the shelf is empty before adjusting.

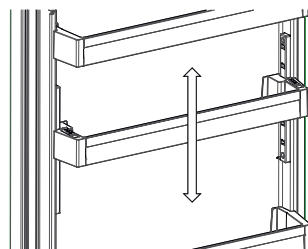

FREEZER STORAGE

SLIDING SHELF

The pull-out open shelf, allows quick and easy access to regularly used items.

REMOVING THE FREEZER BOXES:

- › Pull the box out as far as possible.
- › Pull the front of the box up and out.



Carry out the opposite of this operation when refitting the sliding compartment.



Always keep hold of the handle of the box while removing it.

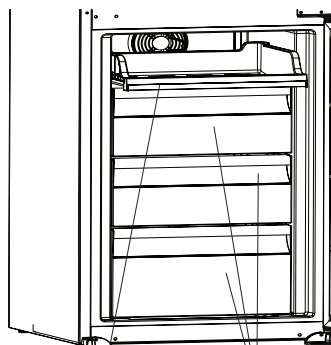

Sliding Shelf

Freezer Boxes

FOOD STORAGE

REFRIGERATOR COMPARTMENT

- › To reduce humidity and avoid the consequent formation of frost, always store liquids in sealed containers in the refrigerator. Frost tends to concentrate in the coldest parts of the evaporating liquid and, in time, your appliance will require more frequent defrosting.
- › Never place warm food in the refrigerator. Warm food should be allowed to cool at room temperature and should be arranged to ensure adequate air circulation in the refrigerator compartment.
- › Make sure no items are in direct contact with the rear wall of the appliance as frost will develop and packaging will stick to it. Do not open the refrigerator door frequently.
- › We recommend that meat and clean fish are loosely wrapped and stored on the glass shelf just above the vegetable bin where the air is cooler, as this provides the best storage conditions.
- › Store loose fruit and vegetable items in the crisper containers.
- › Storing fruit and vegetables separately helps prevent ethylene-sensitive vegetables (green leaves, broccoli, carrot, etc.) being affected by ethylene-releaser fruits (banana, peach, apricot, etc.).
- › Do not put wet vegetables into the refrigerator.
- › Storage time for all food products depends on the initial quality of the food and an uninterrupted refrigeration cycle before refrigerator storage.
- › To avoid cross-contamination do not store meat products with fruit and vegetables. Water leaking from meat may contaminate other products in the refrigerator. You should package meat products and clean any leakages on the shelves.
- › Do not put food in front of the air flow passage.
- › Consume packaged foods before the recommended expiry date.



NOTE:

Potatoes, onions and garlic should not be stored in the refrigerator. The table below is a quick guide to show you the most efficient way to store the major food groups in your refrigerator compartment.

TO AVOID CONTAMINATION OF FOOD, PLEASE RESPECT THE FOLLOWING INSTRUCTIONS:

- › Opening the door for long periods can cause significant increase of the temperature in the compartments of the appliance.
- › Regularly clean surfaces that can come in contact with food accessible drainage systems.
- › Store raw meat and fish in suitable containers in the refrigerator, so that it is not in contact with or drips onto other food.
- › Two -star frozen-food compartments are suitable for storing pre-frozen food, storing or making ice cream and making ice cubes.
- › One-, two- and three-star compartments are not suitable for freezing of fresh food.
- › If the refrigerating appliance is left empty for long periods, switch off, defrost, clean, dry and leave the door open to prevent mould developing within the appliance.

FOOD	MAXIMUM STORAGE TIME *	HOW AND WHERE TO STORE
Vegetables and fruits	1 week	Vegetable bin
Meat and fish	2 - 3 days	Wrap in plastic foil, bags, or in a meat container and store on the glass shelf
Fresh cheese	3 - 4 days	On the designated door shelf
Butter and margarine	1 week	On the designated door shelf
Bottled products e.g. milk and yoghurt	Until the expiry date recommended by the producer	On the designated door shelf
Eggs	1 month	On the designated egg tray
Cooked food	2 days	All shelves

These are guidelines only, always refer to the expiry date, or best before date recommended by the producer.

FREEZER COMPARTMENT

- › The freezer is used for storing frozen food, freezing fresh food, and making ice cubes.
- › To freeze fresh food, ensure that as much of the surface of the food as possible is in contact with the cooling surface.
- › Do not store fresh food next to frozen food as it can thaw the frozen food.
- › Before freezing fresh food, divide it into portions that can be consumed in one sitting.
- › Consume thawed frozen food within a short period of time after defrosting
- › Never place warm food in the freezer compartment as it will thaw the frozen food.
- › Always follow the manufacturer's instructions on food packaging when storing frozen food. If no information is provided food, should not be stored for more than 3 months from the date of purchase.
- › When purchasing frozen food, make sure that it has been stored under appropriate conditions and that the packaging is not damaged.
- › Frozen food should be transported in appropriate containers and placed in the freezer as soon as possible.
- › Do not purchase frozen food if the packaging shows signs of humidity band abnormal swelling. It is probable that it has been stored at an unsuitable temperature and that the contents have deteriorated.
- › The storage life of frozen food depends on the room temperature, the thermostat setting, how often the door is opened, the type of food, and the length of time required to transport the product from the shop to your home. Always follow the instructions printed on the packaging and never exceed the maximum storage life indicated.
- › The maximum amount of fresh food (in kg) that can be frozen in 24 hours is indicated on the appliance label.
- › To use the maximum capacity of the freezer compartment, use the glass shelves for the upper and middle section, and use the lower basket for the bottom section.

NOTE:

If you attempt to open the freezer door immediately after closing it, you will find that it will not open easily. This is normal. Once equilibrium has been reached, the door will open easily.

IMPORTANT NOTE:

- › Never refreeze thawed frozen food.
- › The taste of some spices found in cooked dishes (aniseed, watercress, vinegar, assorted spices, ginger, garlic, onion, mustard, thyme, black pepper, etc.) changes and they assume a strong taste when they are stored for a long period of time. Therefore, add small amounts of spices to food to be frozen, or the desired spice should be added after the food has thawed.
- › The storage time of food is dependent on the type of oil used. Suitable oils are margarine, calf fat, olive oil and butter. Unsuitable oils are peanut oil and pig fat.
- › Food in liquid form should be frozen in plastic cups and other food should be frozen in plastic or bags or containers. The table below is a quick guide to show you the most efficient way to store the major food groups in your freezer compartment.

MEAT AND FISH	PREPARATION	MAXIMUM STORAGE TIME (MONTHS)
Steak	Wrap in foil	6 - 8
Lamb meat	Wrap in foil	6 - 8
Veal roast	Wrap in foil	6 - 8
Veal cubes	In small pieces	6 - 8
Lamb cubes	In pieces	4 - 8
Minced meat	In packaging without using spices	1 - 3
Giblets (pieces)	In pieces	1 - 3
Bologna sausage/salami	Should be kept packaged even if it has a membrane	
Chicken and turkey	Wrap in foil	4 - 6
Goose and duck	Wrap in foil	4 - 6
Deer, rabbit, wild boar	In 2.5 kg portions or as fillets	6 - 8
Freshwater fish (Salmon, Carp, Crane, Catfish)	After cleaning the bowels and scales of the fish, wash and dry it. If necessary, remove the tail and head.	2
Lean fish (Bass, Turbot, Flounder)		4
Fatty fishes (Tuna, Mackerel, Bluefish, Anchovy)		2 - 4
Shellfish	Clean and in a bag	4 - 6
Caviar	In its packaging, or in an aluminium or plastic container	2 - 3

NOTE:

Thawed frozen meat should be cooked as fresh meat. If the meat is not cooked after defrosting, it must not be re-frozen.

VEGETABLES AND FRUITS	PREPARATION	MAXIMUM STORAGE TIME (MONTHS)
String beans and beans	Wash, cut into small pieces and boil in water	10 - 13
Beans	Hull, wash and boil in water	12
Cabbage	Clean and boil in water	6 - 8
Carrot	Clean, cut into slices and boil in water	12
Pepper	Cut the stem, cut into two pieces, remove the core and boil in water	8 - 10
Spinach	Wash and boil in water	6 - 9
Cauliflower	Remove the leaves, cut the heart into pieces and leave it in water with a little lemon juice for a while	10 - 12
Aubergine	Cut into pieces of 2cm after washing	10 - 12
Sweet corn	Clean and pack with its stem or as sweet corn	12
Apple and pear	Peel and slice	8 - 10
Apricot and Peach	Cut into two pieces and remove the stone	4 - 6
Strawberry and Blackberry	Wash and hull	8 - 12
Cooked fruits	Add 10 % of sugar to the container	12
Plum, cherry, raspberry	Wash and hull the stems	8 - 12

	MAXIMUM STORAGE TIME (MONTHS)	THAWING TIME AT ROOM TEMPERATURE (HOURS)	THAWING TIME IN OVEN (MINUTES)
Bread	4 - 6	2 - 3	4-5 (220-225 °C)
Biscuits	3 - 6	1 - 1.5	5-8 (190-200 °C)
Pastry	1 - 3	2 - 3	5-10 (200-225 °C)
Pie	1 - 1.5	3 - 4	5-8 (190-200 °C)
Filo dough	2 - 3	1 - 1.5	5-8 (190-200 °C)
Pizza	2 - 3	2 - 4	15-20 (200 °C)
DAIRY PRODUCTS	PREPARATION	MAXIMUM STORAGE TIME (MONTHS)	STORAGE CONDITIONS
Packet (Homogenized) Milk	In its own packet	2 - 3	Pure Milk – in its own packet
Cheese - excluding white cheese	In slices	6 - 8	Original packaging may be used for short-term storage. Keep wrapped in foil for longer periods.
Butter, margarine	In its packaging	6	

CLEANING AND MAINTENANCE



Disconnect the unit from the power supply before cleaning.



Do not wash your appliance by pouring water on it.



Do not use abrasive products, detergents or soaps for cleaning the appliance. After washing, rinse with clean water and dry carefully. When you have finished cleaning, reconnect the plug to the mains supply with dry hands.

- › Make sure that no water enters the lamp housing and other electrical components.
- › The appliance should be cleaned regularly using a solution of bicarbonate of soda and lukewarm water.
- › Clean the accessories separately by hand with soap and water. Do not wash accessories in a dishwasher.
- › Clean the condenser with a brush at least twice a year. This will help you to save on energy costs and increase productivity.



NOTE:

The power supply must be disconnected during cleaning.

DEFROSTING THE REFRIGERATOR COMPARTMENT

- › Your refrigerator performs automatic defrosting. The water formed as a result of defrosting passes through the water collection spout, flows into the vaporisation container behind your refrigerator and evaporates there.
- › Make sure you have disconnected the plug of your refrigerator before cleaning the vaporisation container.
- › Remove the vaporisation container from its position by removing the screws as indicated. Clean it with soapy water at specific time intervals. This will prevent odours from forming.

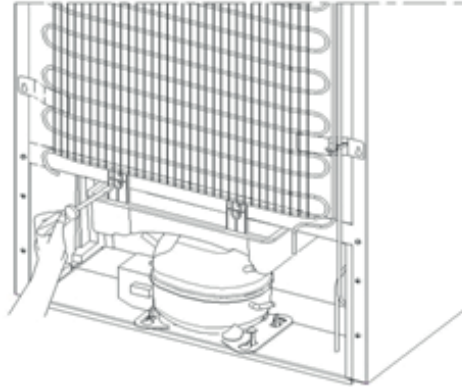

REPLACING LED LIGHTING

LIGHT SOURCE ENERGY CLASS

This product contains a light source of energy efficiency class F.

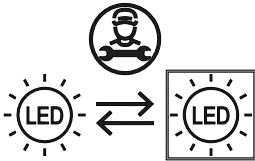

The LED light must be replaced by an authorised engineer or similar only. For more information, please contact Caple service - 0117 938 7420 or service@caple.co.uk



Unplug the unit from the power supply before starting the process.

1. Carefully insert a flat screw driver into the edge of the cover and lift cover off.
2. Remove the LED light from its housing.
3. Disconnect the connector and change the LED light.
4. Implement the steps in reverse order.
5. After waiting 5 minutes, plug the unit.

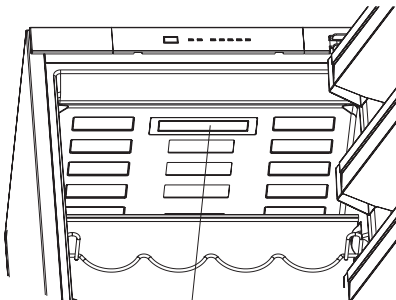

LED strip

HOLIDAY

SHORT HOLIDAYS:

Leave the fridge freezer operating during holidays of less than three weeks.

LONG HOLIDAYS:

If the appliance will not be used for several months, remove all items and turn off the appliance. Clean and dry the interior thoroughly. To prevent odour and mould growth, leave the door open slightly (blocking it open if necessary).

TRANSPORT AND REPOSITIONING

TRANSPORTATION AND CHANGING POSITIONING

- › The original packaging and foam may be kept for re-transportation (optional).
- › Fasten your appliance with thick packaging, bands or strong cords and follow the instructions for transportation on the packaging.
- › Remove all movable parts (shelves, accessories, vegetable bins, and so on) or fix them into the appliance against shocks using bands/tape when re-positioning or transporting.
- ›  Always carry your appliance in the upright position.

TROUBLESHOOTING

BEFORE CALLING FOR SERVICE

Reviewing the information below may save you from calling for service.

ERRORS

Your appliance will warn you if the temperatures for the fridge and freezer are at improper levels or if a problem occurs with the appliance.

If your fridge freezer is not working properly, it may be a minor problem, therefore check the following, before calling an electrician to save time and money.

Warning codes are displayed on the fridge and freezer indicators.

ERROR TYPE	MEANING	WHY	WHAT TO DO
E01-E07	Sensor warning		Call Caple service for assistance as soon as possible.
E08	Low Voltage Warning	Power supply to the device has dropped to below 170V	This is not a failure. This prevents damage to the compressor. The voltage needs to be increased back to required levels. This warning will turn off after the voltage gets to the required level. If this warning continues contact Caple service.
E09	Freezer compartment is not cold enough	Likely to occur after: long term power failure.	1. Set the freezer temperature to a colder value or set Super Freeze. This should remove the error code once the required temperature has been reached. Keep doors closed to improve time taken to reach the correct temperature. 2. Remove any products which have thawed/defrosted during this error. They can be used within a short period of time. 3. Do not add any fresh produce to the freezer compartment until the correct temperature has been reached and the error is no longer. If this warning continues contact Caple service.
E10	Fridge compartment is not cold enough	Likely to occur after: - long term power failure - Hot food has been left in the fridge.	1. Set the fridge temperature to a colder value or set Super Cool. This should remove the error code once the required temperature has been reached. Keep doors closed to improve time taken to reach the correct temperature. 2. Please empty the location at the front area of air duct channel holes and avoid putting food close to the sensor. If this warning continues contact Caple service.
E11	Fridge compartment is too cold	Various	1. Check if Super Cool mode is activated. 2. Reduce the fridge compartment temperature. 3. Check to see if vents are clear and not clogged. If this warning continues contact Caple service.

THE APPLIANCE DOES NOT OPERATE CHECK IF:

- › There is power to the unit
- › The general switch in your home is connected
- › The socket is working. To check this, plug in another appliance that you know is working into the same socket.

THE APPLIANCE PERFORMS POORLY CHECK IF:

- › You have not overloaded the appliance
- › The door is closed perfectly
- › There is no dust on the condenser
- › There is enough space at the rear and side walls for ventilation

YOUR FRIDGE FREEZER IS OPERATING NOISILY

CRACKING (ICE CRACKING):

- › During automatic defrosting.
- › When the appliance is cooled or warmed (due to expansion of appliance material).

SHORT CRACKING:

Heard when the thermostat switches the compressor on/ off.

COMPRESSOR NOISE:

Normal motor noise. This noise means that the compressor operates normally. Compressor may cause more noise for a short time when it is activated.

BUBBLING NOISES:

This noise is caused by the flow of the refrigerant in the tubes of the system.

WATER FLOW NOISE:

Normal flow noise of water flowing to the evaporation container during defrosting. This noise can be heard during defrosting.

AIR BLOW NOISE:

Normal fan noise. This noise can be heard in fridges during normal operation of the system due to the circulation of air.

DOOR JOINTS:

If the edges of fridge cabinet that the door joint contact are warm; especially in summer (hot weather), the surfaces that the joint contact may get warmer during the operation of the compressor, this is normal. If humidity builds up inside the fridge freezer.

IS ALL THE FOOD PACKED PROPERLY?

- › Are the containers dried before placing them in the fridge?
- › Are the fridge freezer's doors opened frequently? Humidity of the room gets in the fridge when the door is opened. Humidity build up will be faster when you open the door more frequently, especially if the humidity of the room is high.

IF THE DOORS ARE NOT OPENED AND CLOSED PROPERLY

- › Do the food packages prevent closing of the door?
- › Are the door compartments, shelves and drawers placed properly?
- › Are door joints broken or torn?
- › Is your fridge freezer on a level surface?

RECOMMENDATIONS

- › To stop the appliance completely, unplug from main socket (for cleaning and when the door is left open).
- › If the appliance is switched off or unplugged, wait at least 5 minutes before plugging the appliance in or restarting it in order to prevent damage to the compressor.

If the problem persists or more help is required, please contact our Caple service team on **0117 938 7420** or via email **service@caple.co.uk**.

SPARE PARTS AVAILABILITY

The original spare parts for some specific components are available for a minimum of 7 or 10 years, based on the type of component, from the placing on the market of the last unit of the model.

For more info and to order spares, please contact Caple service or visit our website www.caple.co.uk.

ENERGY SAVING TIPS

1. Install the appliance in a cool, well ventilated room, but not in direct sunlight and not near a heat source (such as a radiator or oven) otherwise an insulating plate should be used.
2. Allow warm food and drinks to cool before placing them inside the appliance.
3. Place thawing food in the refrigerator compartment. The low temperature of the frozen food will help cool the refrigerator compartment while the food is thawing. This will save energy. Frozen food left to thaw outside of the appliance will result in a waste of energy.
4. Drinks or other liquids should be covered when inside the appliance. If left uncovered, the humidity inside the appliance will increase, therefore the appliance uses more energy. Keeping drinks and other liquids covered helps preserve their smell and taste.
5. Avoid keeping the doors open for long periods and opening the doors too frequently as warm air will enter the appliance and cause the compressor to switch on unnecessarily often.
6. Keep the covers of the different temperature compartments (such as the crisper and chiller) closed.
7. The door gasket must be clean and pliable. Replace gaskets if worn.



Caple Service
Fourth Way
Avonmouth
Bristol
BS11 8DW

T: 0117 938 1900
E: service@caple.co.uk
www.caple.co.uk