



# Free Standing Fridge Freezer Instruction Manual

---

# CAFF46GM



Contact Caple on 0117 938 7420 for spare parts or [www.caple.co.uk](http://www.caple.co.uk)

## CONTENTS

---

Warnings	3
Environmental Protection	13
General Features	14
Electrical Connection	15
Product Overview	16
Dimensions	17
Using The Appliance	19
Accessories	28
Chill Drawer & Humidity Controlled Drawer	29
Installation Accessories	31
Food Storage	32
Cleaning And Maintenance	40
Replacing the LED Light	41
Transport And Repositioning	42
Troubleshooting	43
Energy Saving Tips	47
Caple Contact Details	49

# SAFETY INSTRUCTIONS

Read these instructions carefully and completely before using your appliance. They provide you with important information regarding the safe installation, use and maintenance of the appliance as well as useful advice for getting the best out of your fridge freezer. Keep this booklet in a safe place for future reference and pass on to any future owner.

- This appliance is produced in accordance with all applicable local and international standards and regulations.
- This appliance is intended to be used in household and similar applications such as:
  - › Staff kitchen areas in shops, offices and other working environments.
  - › Farm Houses.
  - › By clients in hotels, motels and other residential type environments.
  - › Bed and breakfast type environments.
- This appliance may only be used by persons (including children) with reduced physical, sensory or mental capabilities, or lack of experience and knowledge, if they are supervised whilst using it. They may only use it unsupervised if they have been shown how to use it in a safe manner. They must be able to recognise and understand the dangers of misuse.

## **SAFETY WITH CHILDREN:**

- This appliance can be used by children aged from 8 years and above.
- Children less than 8 years of age should be kept away unless continuously supervised or they have been shown how to use it in a safe manner. Children must be able to understand and recognise the possible dangers caused by incorrect operation.
- Children should be supervised in the vicinity of the appliance.
- Never allow children to play with the appliance.
- Cleaning and user maintenance should not be carried out by children without supervision.
- Children aged from 3 to 8 years are allowed to load and unload refrigerating appliances.
- Materials used for packaging (nylon, staplers, Styrofoam etc.) may cause harmful effects to children, they should be disposed of immediately.
- Children can injure themselves on an open door. Do not let children sit on the open door, lean against it or swing on it.

## **TECHNICAL SAFETY:**

- Maintenance and repair work must be made only by authorised Caple service technicians. Installation and repair work that is carried out by unauthorised technicians may endanger you.
- While the appliance is under warranty, repairs should only be undertaken by a Caple authorised service technician. Otherwise the warranty will be invalidated.
- It is dangerous to alter or modify the specifications of the appliance in any way. The requirements for this appliance are stated on the rating label.
- Risk of injury due to electric shock. Any contact with live connections or tampering with the electrical or mechanical components of the appliance will endanger your safety and may lead to the appliance malfunctioning.
- To maintain the efficiency and safety of your appliance, we recommend you always use original spare parts and to call only our authorised Caple Service agents in case of need.
- Multi-socket adapters and extension leads should not be used to connect the appliance to the mains electricity supply.
- The electrical system of this appliance may be used safely only when it is correctly connected to an efficient earthing system in compliance with the safety standards currently in effect.

- Insert the plug into a socket with an efficient ground connection. If the socket has no ground contact or the plug does not match, we recommend you consult a qualified electrician for assistance.
- The appliance must be connected with a properly installed fused socket. The power supply (AC) and voltage at the operating point must match with the details on the rating plate of the appliance.
- Consult a qualified electrician or service person if the Grounding instructions are not completely understood, or if you have doubts on whether the appliance is properly grounded.
- The incorrect grounding may cause breakdown and electric shock.
- We do not accept responsibility for any damages that occur due to ungrounded usage.
- If the socket does not match the refrigerator plug, it must be replaced by the manufacturer, a service agent or similarly qualified persons in order to avoid a hazard.
- A specially grounded plug has been connected to the power cable of your refrigerator. This plug should be used with a specially grounded socket of 13 amperes. If there is no such socket in your house, please have one installed by an authorised electrician.

## INSTALLATION WARNINGS:

- **⚠️ WARNING:** In order to avoid any hazards resulting from the instability of the appliance, it must be fixed in accordance with the instructions.
- Prior to installation, ensure that the local distribution conditions (electricity voltage and frequency) and the requirements of the appliance are compatible.
- During installation the appliance must be completely disconnected from the mains electricity supply.
- Do not operate the appliance before it is fully installed.
- The appliance must be installed by an authorised technician.
- In order to avoid any hazards resulting from the instability of the appliance, it must be fixed in accordance with the following instructions.
- This appliance is not intended for use at altitudes exceeding 2000m.
- Your appliance must be at least 50cm away from stoves, gas ovens and heater cores, and at least 5cm away from electrical ovens.
- If your fridge freezer is placed next to a deep fridge, there must be at least 2cm between them to prevent humidity forming on the outer surface.
- Do not cover the body or top of fridge with lace. This will affect the performance of your fridge.

- Clearance of at least 100mm is required at the top of your appliance. Do not place anything on top of your appliance.
- Caple is not responsible for any damage that may be caused by defective placement and installation by unauthorised persons.
- When unpacking the appliance, make sure that it is not damaged during transportation.
- Check the appliance for any damage.
- In the case of any defect; do not use the appliance and contact your retailer or Caple Service immediately.
- **⚠ WARNING:** Ensure that the supply cord is not wedged, trapped or damaged during the installation. If the supply cord is damaged, it must be replaced by a Caple service technician or similarly qualified persons in order to prevent a hazard.
- Never touch the power cord/plug with wet hands. This may cause a short circuit or electric shock.
- The plug must be accessible after installation.
- **⚠ WARNING:** Do not locate multiple portable socket-outlets or portable power supplies at the rear of the appliance.
- Protect your appliance against atmospheric effects. Do not expose it to effects such as sun, rain, snow etc.

## DURING USE:

- **⚠️ WARNING:** Do not damage the refrigerant circuit.
- Do not store explosive substances such as aerosol cans with a flammable propellant in this appliance.
- Place drinks with high alcohol content vertically in the fridge compartment and make sure their tops are tightly closed.
- If you know you will not be using the appliance for a while switch it off from the main supply and unplug it.
- **⚠️ WARNING:** Keep ventilation openings, in the appliance enclosure or in the built-in structure, clear of obstruction.
- Do not place your appliance on a carpeted surface as this will prevent adequate ventilation.
- When the appliance is not in use, we recommend you turn it off, and isolate it from the electrical supply.
- This appliance must be used in the vertical position on a flat surface.
- **⚠️ WARNING:** Do not use electrical appliances inside the food storage compartments of the appliance, unless they are of the type recommended by the manufacturer.
- The manufacturer will not be held liable for any damages that might arise out of incorrect or improper use of the appliance.
- Do not touch frozen goods with wet hands. Your hands may freeze to the frozen food.

- Do not eat ice-cream or ice cubes immediately after they are removed from the freezer compartment. Frozen food can cause frost burn to the lips and tongue.
- Do not re-freeze partially or fully thawed food. This may cause health issues such as food poisoning. Defrosted food may only be re-frozen after it has been cooked.
- Do not place glass bottles or cans containing carbonated drinks in the freezer compartment as they will burst when the contents freezes.
- If using the appliance to quickly cool drinks, do not leave bottles inside the freezer compartment for more than 1 hour, otherwise they could burst.

## CLEANING AND MAINTENANCE:

- Clean the appliance thoroughly before use.
- Always switch off the appliance from the mains isolating the electrical supply before any cleaning or maintenance.
-  **WARNING:** Do not use mechanical devices or other means to accelerate the defrosting process, other than those recommended by the manufacturer.

## TRANSPORT:

- Always transport the appliance in its original packaging and in an upright position.
-  If your appliance uses R600a as a refrigerant, you should take care during transportation and installation to prevent the cooler elements from being damaged. R600a is an environmentally friendly and natural gas, but it is explosive. In the event of a leak due to damage of the cooler elements, move your fridge away from open flames or heat sources and ventilate the room where the appliance is located for a few minutes.
- Never use the door handles for lifting.
- The appliance is heavy and could cause injury, it must be transported by two people.

## DISPOSAL OF OLD APPLIANCE:

- Old fridges and fridges contain isolation material and refrigerant with CFC. Therefore, take care not to harm environment when you are discarding your old fridges.
- If your old fridge or fridge has a lock, break or remove the lock before discarding it, because children may get trapped inside it and may cause an accident.
- Be careful to avoid damaging the pipework before disposal, e.g. by puncturing coolant channels, bending pipework, scratching the surface coating.



**WARNING**

Serious injury or death risk



**RISK OF ELECTRIC SHOCK**

Dangerous voltage risk



**FIRE**

Warning; Risk of fire / flammable materials



**CAUTION**

Injury or property damage risk



**IMPORTANT**

Operating the system correctly



Symbol ISO 7010 W021

Warning; Risk of fire / flammable materials



## ENVIRONMENTAL PROTECTION

Waste electrical products should not be disposed of with household waste. Please recycle where facilities exist. Check with your Local Authority or retailer for recycling advice. This appliance is marked according to the European Directive on Waste Electrical and Electronic Equipment (WEEE).

By ensuring this product is disposed of correctly, you will help prevent potential negative consequences for the environment and human health, which could otherwise be caused by inappropriate waste handling of this product. The symbol on the product indicates that this product may not be treated as household waste. Instead it shall be handed over to the applicable collection point for the recycling of electrical and electronic equipment. Disposal must be carried out in accordance with local environmental regulations for waste disposal.

For more detailed information about treatment, recovery and recycling of this product, please contact your local council, your household waste disposal service or the retailer where you purchased the product.

## CE DECLARATIONS OF CONFORMITY

This appliance has been manufactured to the strictest standards and complies with all applicable legislation, Low Voltage Directive (LVD) and Electromagnetic Compatibility (EMC).

## UKCA DECLARATIONS OF CONFORMITY

This appliance has been manufactured to the strictest standards and complies with all applicable legislation.

## TECHNICAL FICHE

This appliance conforms to all current and applicable energy regulations. To view the Technical Fiche that supports the energy labelling data, please visit the product page on our website [www.caple.co.uk](http://www.caple.co.uk)

## WARRANTY

Your new appliance is covered by warranty. The warranty card is enclosed - if it is missing, you must provide the following information to your retailer in order to receive a replacement: date of purchase, model and serial number (placed on the inside of the appliance storage drawer). Registration can also be completed online by visiting [www.caple.co.uk](http://www.caple.co.uk).

Ensure you keep your warranty card safe, you may need to show it to Caple Service together with proof of purchase.

If you fail to show your warranty card you will incur all repair charges.

Spare parts are only available from Caple Service and spare parts authorised centres.

## GENERAL FEATURES

---

- › When the doors are closed, check if there are any gaps between door gasket and the body. If there are any gaps, contact Caple service immediately.
- › When the freezer door is closed, a vacuum is formed. Do not force the door open immediately. Please wait until the pressure has stabilised.
- › Air circulation of the fridge and freezer compartments are not mixed with other compartments thanks to the frost-free technology. This technology stops odours passing through compartments, and also allows vegetables to stay fresh for longer.
- › The fan will often run independently even if the compressor is not running. This maintains a better air circulation, and is energy efficient.
- › Through a specific air flow design, fans give out cold air from multiple outlets on all shelf levels, maintaining a more consistent temperature throughout.
- › The display edges and corners form a smooth surface against the door and ensure a perfect appearance. Thanks to the touch control panel, temperature controls can be adjusted easily.
- › The interior LED light turns on gradually instead of sudden light. The LED lights up to 100% brightness within a few seconds after the door is opened.
- › Telescopic rails used in the chill drawer ensure that it operates easily and quietly.
- › The chill drawer is fitted with soft close runners to prevent it from slamming shut. This function eliminates the risk of the drawers staying partially open.
- › Finger print proof doors never leave finger prints thanks to a special layer coated over the gunmetal door.

## ELECTRICAL CONNECTION

---

For your safety please read the following information

**!** **WARNING:**

This appliance must be earthed.

This appliance operates from 220-240 volts and should be protected by a 13 amp fuse in the plug.

**!** **⚡** **IMPORTANT:**

Do not use the appliance without the fuse cover in position.

The appliance is supplied with a standard 13 amp 3-pin mains plug fitted with a 13-amp fuse. Should the fuse require replacement, it must be replaced with a fuse rated at 13 amp and approved to BS1362.

The mains lead of this appliance has been fitted with a BS 1363A 13A fused plug. To change a fuse in this type of plug, follow the steps below:

1. Remove the fuse cover and fuse.
2. Fit replacement 13A fuse, ASTA approved to BS 1362 type, into the fuse cover.
3. Replace fuse cover.

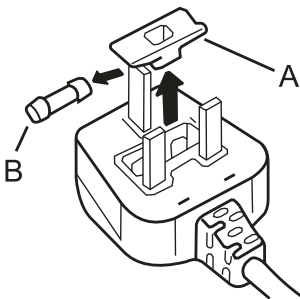

## PRODUCT OVERVIEW

### A. Fridge compartment

### B. Freezer compartment B1. Zone-1 / B2. Zone-2

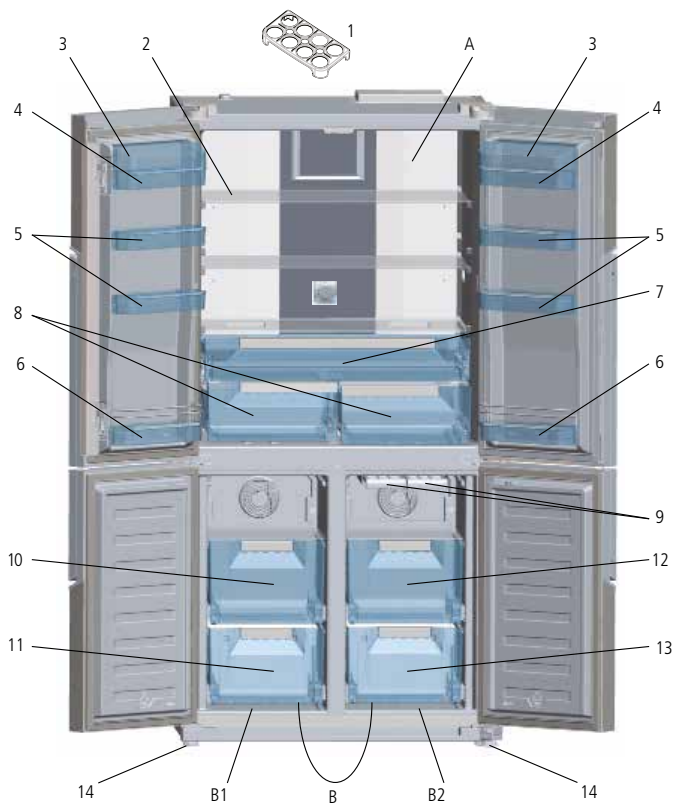

- |                               |                                |                           |
|-------------------------------|--------------------------------|---------------------------|
| 1. Egg holder                 | 6. Door shelves                | 11. Freezer bottom basket |
| 2. Fridge compartment shelves | 7. Chill Drawer                | 12. Freezer top basket    |
| 3. Door top shelf covers      | 8. Humidity Controlled Drawers | 13. Freezer bottom basket |
| 4. Door shelves               | 9. Ice box trays               | 14. Adjustable legs       |
| 5. Door bottle shelves        | 10. Freezer top basket         |                           |



This presentation is only for information about the parts of the appliance. Parts may vary according to the appliance model.

## DIMENSIONS

In order for the product to work efficiently, there must be space around it for air circulation. If you are going to place the product in a recessed area on the wall, the gap should be 100mm between top surface and ceiling and 50mm between walls and side panels.

The distance between the appliance and back wall must be a minimum of 75mm.

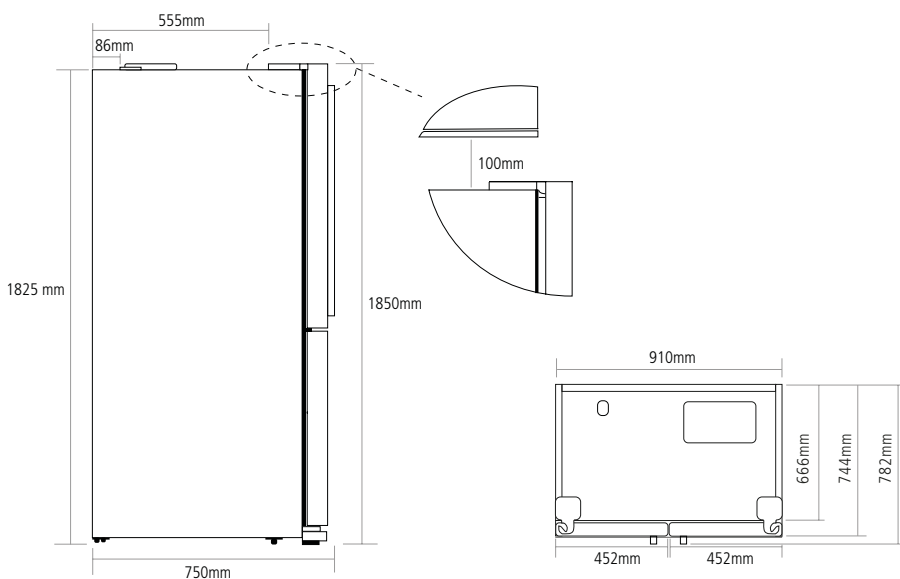
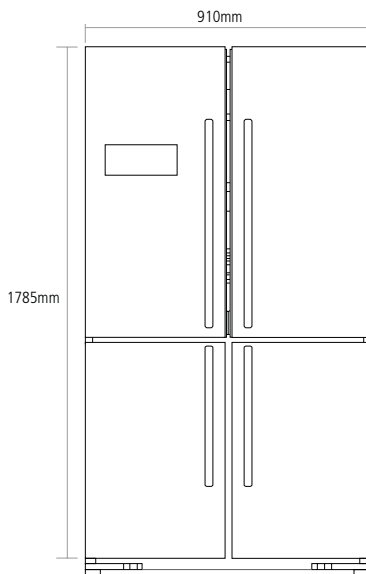

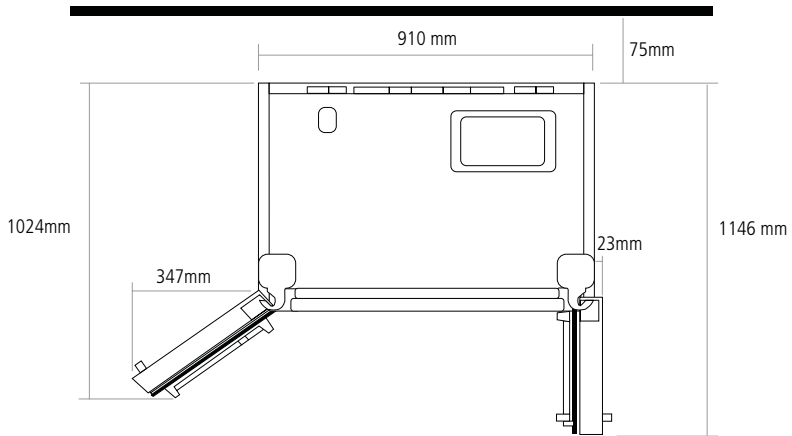
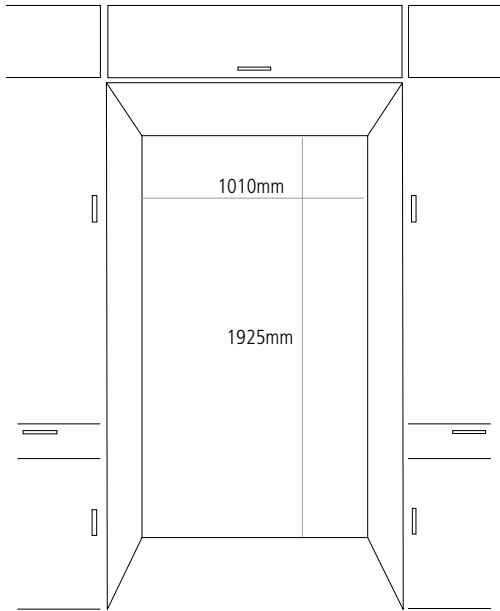

## USING THE APPLIANCE

---

- › Before using your fridge freezer, wipe all parts with a solution of warm water and a teaspoon of sodium bicarbonate. Then, rinse with clean water and dry. Return all parts to the fridge freezer after cleaning.
- › Remove all transport tapes and foam protection pieces. Clean the interior with a cloth dampened in lukewarm soap and water. Rinse with clean water and dry.
- › Use the adjustable front legs to make sure your appliance is level and stable. You can adjust the legs by turning them clockwise (or in the opposite direction). This should be done before placing food in the fridge.
- › Your fridge freezer may have an odour when it is operated for the first time. This is normal and the odour will fade when your fridge freezer starts to cool.
- › When the product is running, high temperature can be noticed on the side panels. This is normal.

### **WARNING:**

Connect to the electrical socket but do not switch the power to the refrigerator on for at least 12 hours. The coolant within the product needs time to settle after it has been transported and put into position, failure to do this will affect the cooling performance of your appliance.

## FROST FREE TECHNOLOGY

Fridge-freezers with Frost-free technology have a different operating system to static fridge-freezers.

In normal (static) fridge-freezers, the humidity entering the fridge-freezer due to opening the door, and the humidity inherent in the food, causes frost build-up in the fridge and freezer compartments.

To defrost the frost and ice in the freezer compartment, you are required to periodically switch off the fridge, place the frozen food in a separate cooled container, then remove the ice gathered in the freezer compartment. The situation is completely different in Frost free fridge-freezers.

A built-in fan blows dry and cold air evenly throughout the fridge and freezer compartments. The cold air disperses uniformly, ensuring all your food is cooled equally, thus preventing humidity and ice build-up.

In the refrigerator compartment, air blown by the fan, located at the top of the refrigerator compartment, is cooled while passing through the gap behind the air duct. At the same time, the air is blown out through the holes in the air duct, evenly spreading cool air throughout the refrigerator compartment.

There is no air passage between the freezer and refrigerator compartments, therefore preventing the mixing of odours. Therefore, your Frost-free fridge-freezer allows ease of use, in addition to its huge capacity and stylish appearance.



## DISPLAY AND CONTROL PANEL

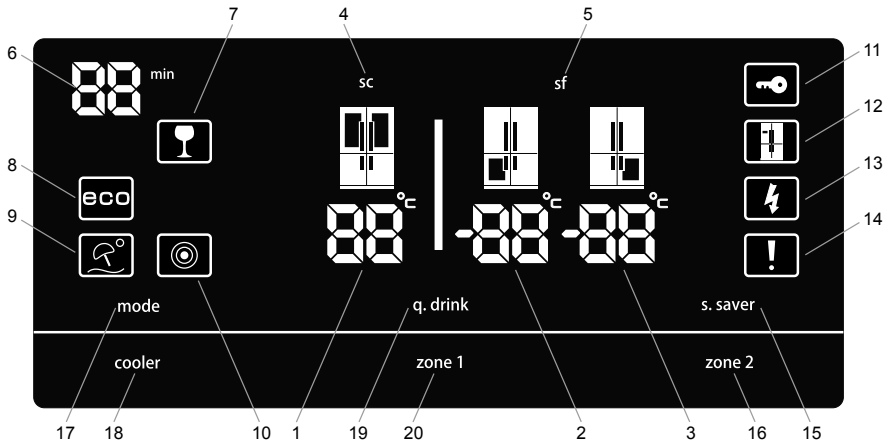

- |   |                                   |
|---|-----------------------------------|
| 1. Fridge compartment temperature indicator       | 10. Night Sensor                  |
| 2. Left freezer compartment temperature indicator | 11. Child lock                    |
| 3. Right freezer compartment temperature          | 12. Demo mode                     |
| 4. Super Cool mode light                          | 13. Low voltage warning           |
| 5. Super Freeze mode light                        | 14. Alarm                         |
| 6. QDrink alarm timer                             | 15. Screensaver button            |
| 7. QDrink alarm light                             | 16. Zone 2 (right freezer) button |
| 8. Economy mode                                   | 17. Mode button                   |
| 9. Holiday mode                                   | 18. Cooler button                 |
|   | 19. Qdrink mode button            |
|   | 20. Zone 1 (left freezer) button  |



The values on the screen indicate temperature values specified by the consumer.



The Standby display is protected against faulty contact. Therefore, you must touch any key on the display before you make an action. After 2 seconds, a beep will sound and the display will be ready for use. Wait 20 seconds at the end of the process and the display will return to Standby mode.

## BEVERAGE COOLING (QDRINK)

This function allows you to store bottled drinks in the freezer to cool them quickly. An alarm sounds to warn you to remove them after a certain period of time.

Qdrink button should be pressed to activate beverage cooling mode. Each press will increase the time for 5 minutes up to 30 minutes, and then it returns to zero. You can view the time zone you want to set on "Qdrink alarm timer" section. An alarm will sound when the mode is complete.



### IMPORTANT:

It should not be confused with cooling.

You must adjust the time according to the temperature of the bottles before you put them in the freezer compartments. For example, you can set the time as "5 minutes" in the beginning. After this time, if the cooling is insufficient, you might set another 5 or 10 minutes. While using this mode, you must check the temperature of the bottles regularly. When the bottles are cool enough, you must take them out of the appliance. If you forget bottles in Q.Drink mode, bottles may explode.

## ECONOMY MODE (ECO)

Energy saving. During periods of less frequent use (door opening) or absence from home, such as a Holiday, Economy Mode can provide optimum temperature whilst saving power.

In order to activate "ECO" mode, press the "mode" button until the eco symbol and "E" illuminate.

## HOLIDAY MODE (H)

Holiday mode is represented by an umbrella and sun symbol on the display. If the cooler compartment will not be used for a long period of time, such as during a holiday, activate this mode. To switch the appliance to holiday mode, you should just press the [mode] button until holiday mode symbol and "H" illuminate.

## **SUPER FREEZE (SF)**

Press the "zone 1" or "zone 2" button until "SF" appears on the display. Once "SF" is displayed, a beep will sound and after a few seconds the mode will be active. You can use this mode to freeze prepared meals or freeze large amounts of food quickly. Super freeze mode will automatically deactivate after 18.5 hours or once the freezer compartment temperature sensor detects the correct temperature.



### **NOTE:**

Using the super freeze mode, freezing capacity will reach the maximum value.

## **SUPER COOL (SC)**

Press the cooler button until "SC" appears on the display. Once "SC" letters are displayed, a beep will sound and after a few seconds the mode will be active. You can use this mode to cool prepared meals or cool large amounts of food quickly. Super cool mode will be automatically cancelled after 4 or 6 hours depending on the ambient temperature or when the cooler compartment reaches a sufficiently low temperature.

## **CHILD LOCK**

To activate the child lock, press and hold the cooler and "zone 2" buttons simultaneously for 3 seconds. When the child lock is active, no changes can be made to settings as the buttons will be inactive. To deactivate child lock, press and hold the cooler and "zone 2" buttons simultaneously for 3 seconds.

## **SCREENSAVER (SCREEN SAVER)**

The screensaver function saves energy by switching the lights on the electronic display panel off. To activate this function, press and hold the "s.saver" button for 3 seconds. To deactivate the mode, press the "s.saver" button for 3 seconds.

## **NIGHT SENSOR**

The night sensor function saves energy by switching the lights inside the refrigerator off if there is sufficient illumination in the room. To activate this function, press and hold the mode and "s.saver" button for 3 seconds. To deactivate this function, press and hold the mode and "s.saver" button for 3 seconds.

## **DEMO MODE**

This mode is used by service and not related to the use of refrigerator.

## **ALARM**



Once an alarm light illuminates, you should contact Caple service. If you press the "s.saver" button when there is an alarm and an exclamation mark on the display, the alarm sound will turn off, however the exclamation mark will stay on the digital indicator panel until the error is fixed.

## **DOOR OPEN ALARM**

If the fridge door is left open for more than 2 minutes, an audible alarm will sound. Close the fridge door.

## COOLER (COOLER)

The cooler mode is used for setting the temperature of the cooler compartment. Press the "cooler" button to set the temperature of the cooler to 1, 2, 3, 4, 5, 6, 7, 8°C.

## FREEZER / COOLER 1 (ZONE 1)

To use the zone 1 compartment as a freezer, press the "zone1" button to set the temperature of the bottom-left compartment to -14, -15, -16, -17, -18, -19, -20, -21, -22, -23 or -24 °C.

To use the bottom-left compartment as a cooler, press and hold the "zone1" button for 3 seconds. Then, set the temperature to 1, 2, 3, 4, 5, 6, 7 or 8 °C.

## FREEZER (ZONE 2)

Press the "zone2" button to set the temperature of the bottom-right compartment to -14, -15, -16, -17, -18, -19, -20, -21, -22, -23 or -24 °C.

## RECOMMENDED TEMPERATURE SETTINGS

FREEZER COMPARTMENT	COOLER COMPARTMENT	REMARKS
-18°C	4°C	For regular use and best performance.
-20°C, -21°C, -22°C, -23°C or -24°C	4°C	Recommended when environmental temperature exceeds 30°C.
Super Freeze	4°C	Must be used when you wish to freeze food in a short period of time.
-18°C, -19°C, -20°C, -21°C, -22°C, -23°C or -24°C	2°C	These temperature settings must be used when the environmental temperature is high or if you think the refrigerator compartment is not cool enough because the door is being opened frequently.

## COMPARTMENT ON-OFF MODE

To turn off freezer Zone1, Zone2 and the cooler at the same time, press and hold the "mode" and "cooler" buttons simultaneously for 3 seconds. All figures indicating the part turned off will disappear on the digital indicator panel.

To turn off the Zone1 compartment, press and hold the "mode" and "zone 1" buttons simultaneously for 3 seconds. All figures indicating the part turned off will disappear on the digital indicator panel.

To reactivate the turned-off compartment, use the same combination of buttons.

## USING THE FREEZER COMPARTMENT (ZONE 1) AS A FRIDGE COMPARTMENT

The bottom left compartment on the appliance can be used either as freezer or as a fridge. Press and hold the "zone 1" button for 3 seconds to change the bottom-left compartment from a freezer to a fridge.



### IMPORTANT:

If the Zone1 compartment will be converted from a freezer to a fridge:

- › Empty the food from the Zone1 compartment and leave the door closed for four hours. Then food can be placed in the compartment.
- › Baskets and/or shelves removed from the compartment should be re-fitted.

Similarly, in order to utilise this compartment as a freezer again, press and hold the related compartment button for 3 seconds.



### IMPORTANT:

If the Zone1 compartment will be converted from a fridge to a freezer:

- › Empty the food from the Zone1 compartment and leave the door closed for two hours. Then food can be placed in the compartment.
- › When the zone 1 compartment is used as a cooler and the appliance is switched to Holiday or Economic mode, the zone 1 compartment will keep on running as cooler.

## TEMPERATURE ADJUSTMENT WARNINGS

- › It is not recommended that you operate your fridge freezer in environments colder than 10°C in terms of its efficiency.
- › Do not start another adjustment while you are already making an adjustment.
- › Temperature adjustments should be made according to the frequency of door openings, the quantity of food kept inside the fridge and the ambient temperature in the location of your fridge.
- › In order to allow your fridge freezer to reach the operating temperature after being connected to mains, do not open the doors frequently or place large quantities of food in the fridge.
- › Please note that, depending on the ambient temperature, it may take 24 hours for your fridge freezer to reach the operating temperature.
- › A 5 minute delay function is applied to prevent damage to the compressor of your fridge freezer when connecting or disconnecting to mains, or when an energy breakdown occurs. Your fridge freezer will begin to operate normally after 5 minutes.

Your appliance is designed to operate in the ambient temperature range T/SN = 10°C -43°C intervals stated in the standards, according to the climate class displayed on the information label. We do not recommend operating your appliance out of the stated temperature limits in terms of cooling effectiveness.

CLIMATE CLASS	AMBIENT TEMPERATURE
<b>T</b>	Between 16 and 43 (°C)
<b>ST</b>	Between 16 and 38 (°C)
<b>N</b>	Between 16 and 32 (°C)
<b>SN</b>	Between 10 and 32 (°C)

## ACCESSORIES

---

### ICEBOX

- › Hold the icebox from the front and pull it toward you to remove it.

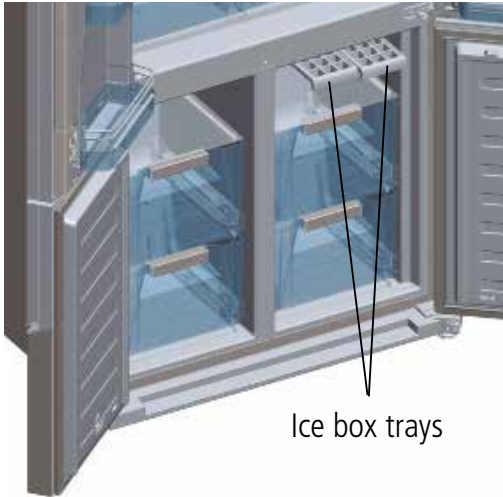

Ice box trays

- › Fill  $\frac{3}{4}$  of icebox with water and insert it.
- › You can take ice out after approximately 2 hours.



#### NOTE:

When placing the icebox after filling with water, make sure that you position it horizontally without tilting. Otherwise, water inside icebox may pour on the basket.

## CHILL DRAWER AND HUMIDITY CONTROLLED DRAWER

---



### CHILL DRAWER

In this compartment, food can be kept at 0°C. Frozen food can be kept in this compartment to defrost. Meat and/or clean fish (in plastic bags or packets), which will be consumed within 1 to 2 days, can also be stored here.



#### NOTE:

Water is frozen at 0°C but food including salt or sugar freezes at colder temperatures.



**Do not put food to be frozen or iceboxes in this compartment.**

## HUMIDITY CONTROLLED DRAWER

When the humidity controller is in the closed position, it allows fresh fruit and vegetables to be stored longer.

When the drawer is totally full, the humidity controller should be opened. By means of this the air in the draw and humidity rate will be controlled and endurance life will be increased. If you see any condensation on the glass shelf above, the humidity control should be moved into the open position.

### NOTE:

The drawers are specifically designed to store fruit & vegetables only. We do not recommend storing meats and/or fish in these drawers.

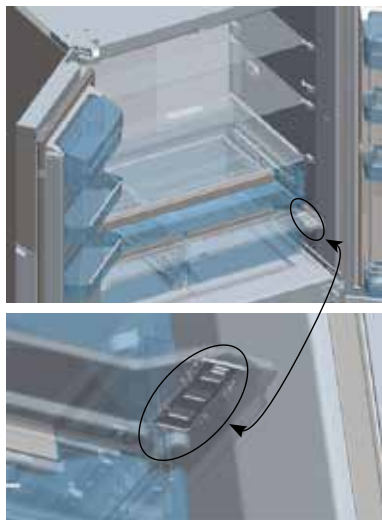

## INSTALLATION ACCESSORIES

---

Your appliance is supplied with the following accessories. Keep these in a safe place should they be needed in future.

### DOOR ALIGNMENT TOOL

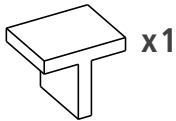

This tool is designed to fit between the doors of your appliance if they need aligning.

### SPACERS

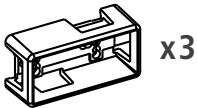

These are supplied as spare parts to those already fixed to your fridge freezer and are located behind the ventilation plinth.

For further information on aligning your appliance doors or installing the spacers, please contact our Caple service team on **0117 938 7420** or via email **service@caple.co.uk**

## FOOD STORAGE

---

### REFRIGERATOR COMPARTMENT

- › For normal operating conditions, set the temperature of the cooler compartment to +4 or +6°C .
- › To reduce humidity and avoid the consequent formation of frost, always store liquids in sealed containers in the refrigerator. Frost tends to concentrate in the coldest parts of the evaporating liquid and, in time, your appliance will require more frequent defrosting.
- › Never place warm food in the refrigerator. Warm food should be allowed to cool at room temperature and should be arranged to ensure adequate air circulation in the refrigerator compartment.
- › Make sure no items are in direct contact with the rear wall of the appliance as frost will develop and packaging will stick to it. Do not open the refrigerator door frequently.
- › We recommend that meat and clean fish are loosely wrapped and stored on the glass shelf just above the vegetable bin where the air is cooler, as this provides the best storage conditions.
- › Store loose fruit and vegetable items in the crisper containers.
- › Storing fruit and vegetables separately helps prevent ethylene-sensitive vegetables (green leaves, broccoli, carrot, etc.) being affected by ethylene-releaser fruits (banana, peach, apricot, etc.).
- › Do not put wet vegetables into the refrigerator.
- › Storage time for all food products depends on the initial quality of the food and an uninterrupted refrigeration cycle before refrigerator storage.
- › To avoid cross-contamination do not store meat products with fruit and vegetables. Water leaking from meat may contaminate other products in the refrigerator. You should package meat products and clean any leakages on the shelves.
- › Do not put food in front of the air flow passage.
- › Consume packaged foods before the recommended expiry date.

- › Avoid placing food in a way that blocks the entrance to air vents. Open ventilation channels provide the best cooling performance.

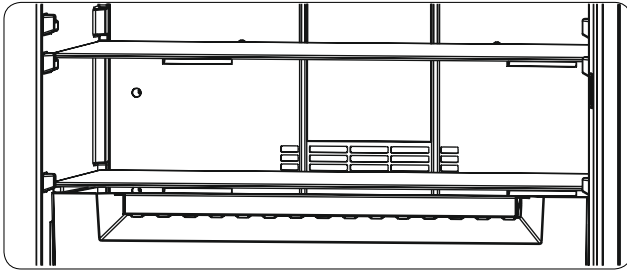

**NOTE:**

Potatoes, onions and garlic should not be stored in the refrigerator. The table below is a quick guide to show you the most efficient way to store the major food groups in your refrigerator compartment.

### **TO AVOID CONTAMINATION OF FOOD, PLEASE RESPECT THE FOLLOWING INSTRUCTIONS:**

- › Opening the door for long periods can cause significant increase of the temperature in the compartments of the appliance.
- › Regularly clean surfaces that can come in contact with food accessible drainage systems.
- › Store raw meat and fish in suitable containers in the refrigerator, so that it is not in contact with or drips onto other food.
- › Two -star frozen-food compartments are suitable for storing pre-frozen food, storing or making ice cream and making ice cubes.
- › One-, two- and three-star compartments are not suitable for freezing of fresh food.
- › If the refrigerating appliance is left empty for long periods, switch off, defrost, clean, dry and leave the door open to prevent mould developing within the appliance.

<b>FOOD</b>	<b>MAXIMUM STORAGE TIME *</b>	<b>HOW AND WHERE TO STORE</b>
Vegetables and fruits	1 week	Vegetable bin
Meat and fish	2 - 3 days	Wrap in plastic foil, bags, or in a meat container and store on the glass shelf
Fresh cheese	3 - 4 days	On the designated door shelf
Butter and margarine	1 week	On the designated door shelf
Bottled products e.g. milk and yoghurt	Until the expiry date recommended by the producer	On the designated door shelf
Eggs	1 month	On the designated egg tray
Cooked food	2 days	All shelves

These are guidelines only, always refer to the expiry date, or best before date recommended by the producer.

## **FREEZER COMPARTMENT**

- › For normal operating conditions, set the temperature of the freezer compartment to -18 or -20°C.
- › The freezer is used for storing frozen food, freezing fresh food, and making ice cubes.
- › To freeze fresh food, ensure that as much of the surface of the food as possible is in contact with the cooling surface.
- › Do not store fresh food next to frozen food as it can thaw the frozen food.
- › Before freezing fresh food, divide it into portions that can be consumed in one sitting.
- › Consume thawed frozen food within a short period of time after defrosting
- › Never place warm food in the freezer compartment as it will thaw the frozen food.
- › Always follow the manufacturer's instructions on food packaging when storing frozen food. If no information is provided food, should not be stored for more than 3 months from the date of purchase.
- › When purchasing frozen food, make sure that it has been stored under appropriate conditions and that the packaging is not damaged.
- › Frozen food should be transported in appropriate containers and placed in the freezer as soon as possible.
- › Do not purchase frozen food if the packaging shows signs of humidity band abnormal swelling. It is probable that it has been stored at an unsuitable temperature and that the contents have deteriorated.
- › The storage life of frozen food depends on the room temperature, the thermostat setting, how often the door is opened, the type of food, and the length of time required to transport the product from the shop to your home. Always follow the instructions printed on the packaging and never exceed the maximum storage life indicated.
- › The maximum amount of fresh food (in kg) that can be frozen in 24 hours is indicated on the appliance label.
- › To use the maximum capacity of the freezer compartment, use the glass shelves for the upper and middle section, and use the lower basket for the bottom section.

### **NOTE:**

If you attempt to open the freezer door immediately after closing it, you will find that it will not open easily. This is normal. Once equilibrium has been reached, the door will open easily.

**IMPORTANT NOTE:**

- › Never refreeze thawed frozen food.
- › The taste of some spices found in cooked dishes (aniseed, watercress, vinegar, assorted spices, ginger, garlic, onion, mustard, thyme, black pepper, etc.) changes and they assume a strong taste when they are stored for a long period of time. Therefore, add small amounts of spices to food to be frozen, or the desired spice should be added after the food has thawed.
- › The storage time of food is dependent on the type of oil used. Suitable oils are margarine, calf fat, olive oil and butter. Unsuitable oils are peanut oil and pig fat.
- › Food in liquid form should be frozen in plastic cups and other food should be frozen in plastic or bags or containers. The table below is a quick guide to show you the most efficient way to store the major food groups in your freezer compartment.

MEAT AND FISH	PREPARATION	MAXIMUM STORAGE TIME (MONTHS)
Steak	Wrap in foil	6 - 8
Lamb meat	Wrap in foil	6 - 8
Veal roast	Wrap in foil	6 - 8
Veal cubes	In small pieces	6 - 8
Lamb cubes	In pieces	4 - 8
Minced meat	In packaging without using spices	1 - 3
Giblets (pieces)	In pieces	1 - 3
Bologna sausage/salami	Should be kept packaged even if it has a membrane	
Chicken and turkey	Wrap in foil	4 - 6
Goose and duck	Wrap in foil	4 - 6
Deer, rabbit, wild boar	In 2.5 kg portions or as fillets	6 - 8
Freshwater fish (Salmon, Carp, Crane, Catfish)	After cleaning the bowels and scales of the fish, wash and dry it. If necessary, remove the tail and head.	2
Lean fish (Bass, Turbot, Flounder)		4
Fatty fishes (Tuna, Mackarel, Bluefish, Anchovy)		2 - 4
Shellfish	Clean and in a bag	4 - 6
Caviar	In its packaging, or in an aluminium or plastic container	2 - 3



**NOTE:**



Thawed frozen meat should be cooked as fresh meat. If the meat is not cooked after defrosting, it must not be re-frozen.

VEGETABLES AND FRUITS	PREPARATION	MAXIMUM STORAGE TIME (MONTHS)
String beans and beans	Wash, cut into small pieces and boil in water	10 - 13
Beans	Hull, wash and boil in water	12
Cabbage	Clean and boil in water	6 - 8
Carrot	Clean, cut into slices and boil in water	12
Pepper	Cut the stem, cut into two pieces, remove the core and boil in water	8 - 10
Spinach	Wash and boil in water	6 - 9
Cauliflower	Remove the leaves, cut the heart into pieces and leave it in water with a little lemon juice for a while	10 - 12
Aubergine	Cut into pieces of 2cm after washing	10 - 12
Sweet corn	Clean and pack with its stem or as sweet corn	12
Apple and pear	Peel and slice	8 - 10
Apricot and Peach	Cut into two pieces and remove the stone	4 - 6
Strawberry and Blackberry	Wash and hull	8 - 12
Cooked fruits	Add 10 % of sugar to the container	12
Plum, cherry, raspberry	Wash and hull the stems	8 - 12

	<b>MAXIMUM STORAGE TIME (MONTHS)</b>	<b>THAWING TIME AT ROOM TEMPERATURE (HOURS)</b>	<b>THAWING TIME IN OVEN (MINUTES)</b>
Bread	4 - 6	2 - 3	4-5 (220-225 °C)
Biscuits	3 - 6	1 - 1.5	5-8 (190-200 °C)
Pastry	1 - 3	2 - 3	5-10 (200-225 °C)
Pie	1 - 1.5	3 - 4	5-8 (190-200 °C)
Filo dough	2 - 3	1 - 1.5	5-8 (190-200 °C)
Pizza	2 - 3	2 - 4	15-20 (200 °C)
<b>DAIRY PRODUCTS</b>	<b>PREPARATION</b>	<b>MAXIMUM STORAGE TIME (MONTHS)</b>	<b>STORAGE CONDITIONS</b>
Packet (Homogenized) Milk	In its own packet	2 - 3	Pure Milk – in its own packet
Cheese - excluding white cheese	In slices	6 - 8	Original packaging may be used for short-term storage. Keep wrapped in foil for longer periods.
Butter, margarine	In its packaging	6	

## CLEANING AND MAINTENANCE

---

-  Disconnect the unit from the power supply before cleaning.
  -  Do not wash your appliance by pouring water on it.
  -  Do not use abrasive products, detergents or soaps for cleaning the appliance. After washing, rinse with clean water and dry carefully. When you have finished cleaning, reconnect the plug to the mains supply with dry hands.
- › Make sure that no water enters the lamp housing and other electrical components.
  - › The appliance should be cleaned regularly using a solution of bicarbonate of soda and lukewarm water.
  - › Clean the accessories separately by hand with soap and water. Do not wash accessories in a dish washer.
  - › Clean the condenser with a brush at least twice a year. This will help you to save on energy costs and increase productivity.



### NOTE:

The power supply must be disconnected during cleaning.

### CLEANING THE EVAPORATION BOWL

Your fridge defrosts automatically. Water produced by defrosting flows into an evaporation container, passing through a water collecting groove, where it vaporises.

### HOLIDAY

**SHORT HOLIDAYS:** Leave the fridge freezer operating during holidays of less than three weeks.

**SHORT HOLIDAYS:** If the appliance will not be used for several months, remove all items and turn off the appliance. Clean and dry the interior thoroughly. To prevent odour and mould growth, leave the door open slightly (blocking it open if necessary).

## REPLACING THE LED LIGHT

---

### LIGHT SOURCE ENERGY CLASS

This product contains light sources of energy efficiency classes E and F.

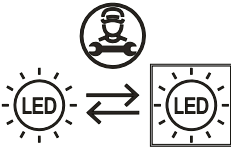

 The LED light must be replaced by an authorised engineer or similar only. For more information, please contact Caple service - **0117 938 7420** or [service@caple.co.uk](mailto:service@caple.co.uk)

 Unplug the unit from the power supply before starting the process.

### DOOR STRIP LIGHTS

1. Remove the 2 screws for the cover and lift the cover off.
2. Carefully remove the LED light with a sharp tool.
3. Disconnect the connector and change the LED light.
4. Implement the steps in reverse order.
5. After waiting 5 minutes, plug the unit.

### ROUND SIDE LIGHTS

1. Carefully insert a flat screw driver into the edge of the cover and lift cover off.
2. Remove the LED light from its housing.
3. Disconnect the connector and change the LED light.
4. Implement the steps in reverse order.
5. After waiting 5 minutes, plug the unit.

## TRANSPORT AND REPOSITIONING

---

### **TRANSPORTATION AND CHANGING POSITIONING**

- › The original packaging and foam may be kept for re-transportation (optional).
- › Fasten your appliance with thick packaging, bands or strong cords and follow the instructions for transportation on the packaging.
- › Remove all movable parts (shelves, accessories, vegetable bins, and so on) or fix them into the appliance against shocks using bands/tape when re-positioning or transporting.
- › Always carry your appliance in the upright position.







**NOTE:**

The refrigerator must be carried by at least 4 people.

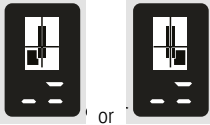
## TROUBLESHOOTING

Your appliance warns you if the temperatures for the fridge and freezer are at improper levels or when a problem occurs in the appliance. Warning codes are displayed in the Freezer and Fridge Indicators.

ERROR TYPE	ERROR TYPE	WHY	WHAT TO DO
	Failure Warning	There is/are some part(s) out of order or there is a failure in the cooling process.	Call a service agent for assistance as soon as possible.
	Freezer compartment is not cold enough	This warning appears if there has been a power failure for a long period or when the refrigerator is operated for the first time.	<ol style="list-style-type: none"> <li>1. Use food within a short time period. Do not freeze foods that has thawed.</li> <li>2. Set the freezer temperature to colder values or set the Super Freeze until the compartment gets to normal temperature.</li> <li>3. Do not put fresh food in the appliance until the fault has cleared.</li> </ol>
	Refrigerator compartment is not cold enough	This warning appears if there has been a power failure for a long period or when the refrigerator is operated for the first time. Ideal temperature for the refrigerator compartment is +4°C. If you see this warning, your foods are at risk of spoiling.	<ol style="list-style-type: none"> <li>1. Set the refrigerator temperature to colder values or set the Super Cool mode until the compartment reaches normal temperature.</li> <li>2. Open the door as little as possible until the fault clears.</li> </ol>
	Refrigerator compartment too cold	The food will start to freeze because the temperature is too cold.	<ol style="list-style-type: none"> <li>1. Check if the Super Cool mode is switched on.</li> <li>2. Decrease the refrigerator temperature values.</li> </ol>
	"Low Voltage" warning	This is seen when the power supply becomes lower than 170 V.	This not a failure. This prevents any damage to the compressor. This warning will clear after the voltage reaches the required level.

## **BEFORE CALLING FOR SERVICE**

Reviewing the information below may save you from calling for service.

### **THE APPLIANCE DOES NOT OPERATE CHECK IF:**

- › There is power
- › The mains is connected
- › The fuse has blown
- › Is the temperature adjustment right?
- › The socket is defective. To check this, plug another working appliance into the same socket.

### **THE APPLIANCE PERFORMS POORLY CHECK IF:**

- › The appliance is overloaded
- › The doors are closed properly
- › There is any dust on the condenser
- › There is enough space near the rear and side walls.

### **THE APPLIANCE IS NOISY CHECK IF:**

- › The appliance is level
- › Anything is touching the rear of the appliance
- › Objects in the appliance are vibrating.

### **YOUR FRIDGE FREEZER IS OPERATING NOISILY:**

- › The following noises can be heard during normal operation of the appliance.

### **CRACKING (ICE CRACKING) NOISE OCCURS:**

- › During automatic defrosting. Also when the appliance is cooled or warmed (due to expansion of appliance material).

**CLICKING NOISE OCCURS:**

- › When the thermostat switches the compressor On/ Off.

**MOTOR NOISE:**

- › Indicates the compressor is operating normally. The compressor may cause more noise for a short time when it is first activated.

**BUBBLING NOISE AND SPLASHING OCCURS:**

- › Due to the flow of the refrigerant in the tubes of the system.

**WATER FLOWING NOISE OCCURS:**

- › Due to water flowing to the evaporation container. This noise is normal during defrosting.

**AIR BLOWING NOISE OCCURS:**

- › During normal operation of the system due to the circulation of air.

**THERE IS A BUILD UP OF HUMIDITY INSIDE THE APPLIANCE****CHECK IF:**

- › All food is packed properly. Containers must be dry before being placed in the appliance.
- › The appliance doors are opened frequently. Humidity in the room with the appliance each time the doors are opened.
- › There is a build-up of water droplets on the rear wall. This is normal after automatic defrosting.

**THE DOORS ARE NOT OPENING OR CLOSING PROPERLY CHECK IF:**

- › There is food or packaging preventing the door from closing.
- › The door compartments, shelves and drawers are placed properly.
- › The door gaskets are broken or torn.
- › Your fridge is level.

## **THE EDGES OF THE APPLIANCE IN CONTACT WITH THE DOOR JOINT ARE WARM:**

- › Especially during warmer weather, the surfaces in contact with the door joint may become warmer during the operation of the compressor. This is normal.

## **RECOMMENDATIONS**

If the appliance is switched off or unplugged, wait at least 5 minutes before plugging the appliance in or restarting it in order to prevent damage to the compressor.

The cooling unit of your refrigerator is located at the rear of the appliance. Therefore, water droplets or ice may form on the rear surface of your fridge due to the operation of the compressor at specified intervals. This is normal, there is no need to perform a defrosting operation unless there is excessive ice.

The appliance you have purchased is designed for domestic use only. It is not suitable for commercial or common use. If the consumer uses the appliance in a way that does not comply with this, we emphasise that the manufacturer and the dealer will not be responsible for any repair and failure within the guarantee period.

If the problem persists or more help is required, please contact our Caple service team on **0117 938 7420** or via email [service@caple.co.uk](mailto:service@caple.co.uk)

## **SPARE PARTS AVAILABILITY**

The original spare parts for some specific components are available for a minimum of 7 or 10 years, based on the type of component, from the placing on the market of the last unit of the model.

For more info and to order spares, please contact Caple service or visit our website [www.caple.co.uk](http://www.caple.co.uk)

## ENERGY SAVING TIPS

---

1. Install the appliance in a cool, well ventilated room, but not in direct sunlight and not near a heat source (such as a radiator or oven) otherwise an insulating plate should be used.
2. Allow warm food and drinks to cool before placing them inside the appliance.
3. Place thawing food in the refrigerator compartment. The low temperature of the frozen food will help cool the refrigerator compartment while the food is thawing. This will save energy. Frozen food left to thaw outside of the appliance will result in a waste of energy.
4. Drinks or other liquids should be covered when inside the appliance. If left uncovered, the humidity inside the appliance will increase, therefore the appliance uses more energy. Keeping drinks and other liquids covered helps preserve their smell and taste.
5. Avoid keeping the doors open for long periods and opening the doors too frequently as warm air will enter the appliance and cause the compressor to switch on unnecessarily often.
6. Keep the covers of the different temperature compartments (such as the crisper and chill drawer) closed.
7. The door gasket must be clean and pliable. Replace gaskets if worn.
8. To save energy, activate the night sensor.





Caple Service	BS11 8DW
Fourth Way	T: 0117 938 1900
Avonmouth	E: <a href="mailto:service@caple.co.uk">service@caple.co.uk</a>
Bristol	<a href="http://www.caple.co.uk">www.caple.co.uk</a>