



Built-in single oven instruction manual

C2236



Contact Caple on 0117 938 7420 or for spare parts www.caple.co.uk





CONTENTS

Safety instructions	3
Environmental protection	6
Preparation for installation and use	7
Oven installation	8
Maintenance and Cleaning	16
Troubleshooting	16
Transport	17
Caple Service contact details	20

Please keep this instruction manual for future reference





SAFETY INSTRUCTIONS

Read these instructions carefully and completely before using your appliance, keep it in a convenient place for reference when necessary.

- This appliance can be used by children aged from 8 years and above.
- Persons with reduced physical, sensory or mental capabilities or lack of experience and knowledge must be supervised and given appropriate instruction concerning the use of the appliance in a safe way and understand the hazards involved.
- Children shall not play with the appliance.
- Cleaning and user maintenance should not be carried out by children without supervision.
- The appliance is not intended to be operated by means of an external timer or separate remote control system.

WARNING:

- The appliance and its accessible parts become hot during use. Care should be taken to avoid touching heating elements.
- Children less than 8 years of age should be kept away unless continuously supervised.
- To prevent fire hazards do not store items on the cooking surfaces.
- If the surface is cracked, switch off the appliance to avoid the possibility of electric shock.

WARNING:

- During use, handles can get hot.
- Do not use harsh abrasive cleaners or sharp metal scrapers to clean the oven door glass or any other surface of the appliance as it can scratch the surface which may result in the glass shattering or permanent damage to the surface.
- Do not use steam cleaners for cleaning the appliance.
- Ensure the appliance is switched off before replacing the lamp to avoid the possibility of electric shock.

CAUTION:

- Accessible parts may be hot when the cooking or grilling is in use. Young children should be kept away.

Please keep this instruction manual for future reference



- Your appliance is produced in accordance with all applicable local and international standards and regulations.
- Maintenance and repair work must be made only by authorised Cadle service technicians. Installation and repair work that is carried out by unauthorised technicians may endanger you.
- It is dangerous to alter or modify the specifications of the appliance in any way.
- Prior to installation, ensure that the local distribution conditions (electricity voltage and frequency) and the requirements of the appliance are compatible. The requirements for this appliance are stated on the rating label.
- This appliance is designed only for cooking food and is intended for indoor use.
- This product is not designed for commercial use, it is a household appliance only. It is not intended to be used in:
 - Staff kitchen areas in shops, offices and other working environments.
 - Bed and breakfast type environments
 - By clients in hotels, motels and other residential type environments
- Do not try to lift or move the appliance by pulling the door handle.
- All possible security measures have been taken to ensure your safety. Since the glass may break, you should be careful while cleaning to avoid scratching.
- Avoid hitting or knocking on the glass with accessories.
- Ensure that the supply cord is not wedged during the installation. If the supply cord is damaged, it must be replaced by a Cadle service technician or similarly qualified persons in order to prevent a hazard.
- While the oven door is open, do not let children climb on the door or sit on it.

INSTALLATION WARNINGS

- Do not operate the appliance before it is fully installed.
- The appliance must be installed by an authorised technician.
- Cadle is not responsible for any damage that may be caused by defective placement and installation by unauthorised persons.
- When unpacking the appliance, make sure that it is not damaged during transportation. In the case of any defect; do not use the appliance and contact your retailer or Cadle Service immediately.
- Materials used for packaging (nylon, staplers, styrofoam etc) may cause harmful effects to children they should be disposed of immediately.
- Protect your appliance against atmospheric effects. Do not expose it to

Please keep this instruction manual for future reference



effects such as sun, rain, snow etc.

- The surrounding materials of the appliance (i.e. kitchen cabinet or furniture) must be able to withstand a minimum temperature of 90°C.

DURING USAGE

- Heat the empty oven at max. temperature for 1 hour – removing any unpleasant smells and smoke caused by working residues and thermal insulation. Make sure you do this in a well ventilated area.
- During usage, the outer and inner surfaces of the oven get hot. While opening the oven door, step back to avoid the hot steam coming out of the oven as there may be a risk of burns.
- Do not put flammable or combustible materials in or near the appliance when it is operating.
- Always use oven gloves to remove and replace food in the oven.
- Pay close attention to the oven while cooking with solid or liquid oils as they could potentially catch fire when oven is hot.
- Never pour water on flames that are caused by oil. Cover the saucepan or frying pan with its lid in order to choke the flame and turn the oven off.
- If you know you will not be using the appliance for a while switch it off from the main supply and unplug it.
- Make sure the appliance control knobs are always in the '0' (stop) position when it is not used.
- The oven shelves and trays incline when pulled out. Be careful not to let hot liquid spill over.
- When the door of the oven is open, do not leave anything on it. It may unbalance your appliance or damage the door.
- Do not put anything heavy, flammable or ignitable (nylon, plastic bag, paper or cloth etc) into the oven. This includes cookware with plastic accessories (e.g. handles). Do not hang towels, dishcloths or clothes from the appliance or its handles.

DURING CLEANING AND MAINTENANCE

- Always switch off the appliance from the mains isolating the electrical supply before any cleaning or maintenance.
- Do not remove the control knobs to clean the control panel.

To maintain the efficiency and safety of your appliance, we recommend you always use original spare parts and to call only our authorised Caple Service agents in case of need.



ENVIRONMENTAL PROTECTION

Waste electrical products should not be disposed of with household waste. Please recycle where facilities exist. Check with your Local Authority or retailer for recycling advice.

This appliance is marked according to the European directive 2002/96/EC on Waste Electrical and Electronic Equipment (WEEE). By ensuring this product is disposed of correctly, you will help prevent potential negative consequences for the environment and human health, which could otherwise be caused by inappropriate waste handling of this product. The symbol on the product indicates that this product may not be treated as household waste. Instead it shall be handed over to the applicable collection point for the recycling of electrical and electronic equipment. Disposal must be carried out in accordance with local environmental regulations for waste disposal.

For more detailed information about treatment, recovery and recycling of this product, please contact your local council, your household waste disposal service or the retailer where you purchased the product.

WARRANTY

Your new appliance is covered by warranty. The warranty card is enclosed - if it is missing, you must provide the following information to your retailer in order to receive a replacement: date of purchase, model and serial number (placed on the inside of the appliance storage drawer). Registration can also be completed online by visiting www.caple.co.uk.

Ensure you keep your warranty card safe, you may need to show it to Caple Service together with proof of purchase.

If you fail to show your warranty card you will incur all repair charges.

Spare parts are only available from Caple Service and spare parts authorised centres.

ATTENTION

- Before use, remove all plastic films protecting some parts of the appliance (fascia - panel, parts in stainless steel, etc)
- Do not use the appliance to heat a room.
- When the appliance is not in use, we recommend you turn it off, isolate it from the electrical supply and ensure all gas taps are closed.

CE DECLARATIONS OF CONFORMITY

This appliance has been designed, constructed and marketed in compliance with safety requirements in force. This appliance has been manufactured to the strictest standards and complies with all applicable legislation.

Please keep this instruction manual for future reference



Preparation for installation and use

Manufactured with best quality parts and materials, this modern, functional and practical oven will meet your needs in all respects. Please read the manual thoroughly before use for best results to ensure you do not experience any problems in the future. The information in this manual outline the necessary procedures for correct positioning and service operations. They should be read without fail especially by the technician installing the appliance. Contact an authorised installer for the installation of your oven.

Choosing a place for the oven

There are several points to pay attention to when choosing a place for your oven. Make sure to take into account our recommendations in order to prevent any problems and dangerous situations, which might occur later

- When choosing a place for the oven, attention should be paid that there are no flammable or combustible materials in close vicinity, such as curtains, oil, cloth etc. which quickly catch fire.
- Furniture surrounding the oven must be made of materials resistant to heat of at least 90°C.
- The dimensions and materials in which the oven will be installed must be correct and resistant to increases in temperature. Installing the appliance in close vicinity of a refrigerator or freezer is not recommended as it may affect their performance due to emanating heat from the oven.
- Once positioned and packaging is removed, check the oven is in a good condition, if the oven is damaged do not use it and contact your retailer immediately.

Please keep this instruction manual for future reference

OVEN INSTALLATION

- Insert the oven by pushing it into the cabinet.
- Open the oven door and insert 2 screws in the holes located on the oven frame.
- While the product frame touches the wooden surface of cabinet, tighten the screws.
- If the oven is installed under a hob, the distance between the top surface of the worktop and the top panel of the oven must be a minimum of 50 mm and the distance between the top surface of the worktop and the top of control panel must be minimum 25 mm.

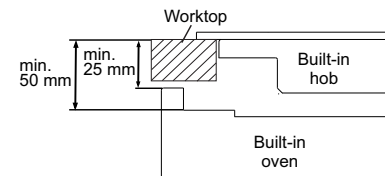
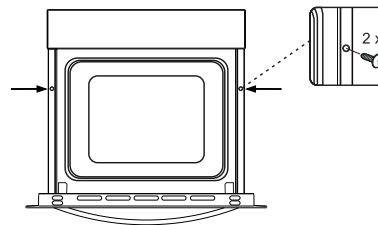
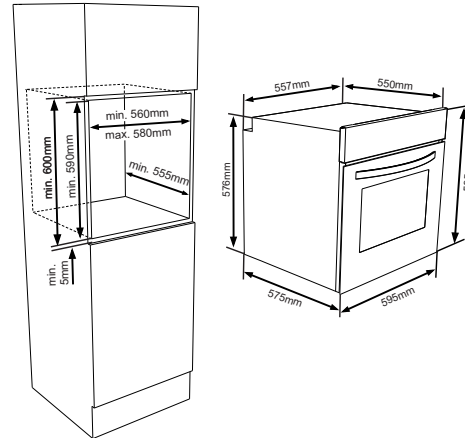
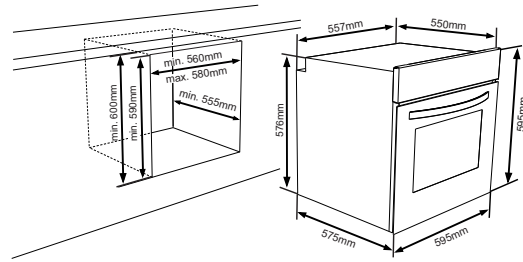

Wiring and safety

The instructions given below must be followed without fail during wiring:

- The earthing cable must be connected via the screw with the earthing mark. Supply cable connection must be as shown in Figure 2. If there is no earthed outlet conforming to regulations in the installation environment, call Caple Service immediately.
- The installation must include a suitable isolating switch with a minimum contact opening of 3mm between the appliance and the mains. The isolating switch should be sized according to the load on the rating plate and should comply with current regulations.
- The earthed outlet must be in close vicinity of the appliance. Never use an extension cord.
- The fuse rating for this appliance is 16amp.
- The supply cable should not make contact with the product's hot surface.
- In case of any damage to the supply cable, make sure to call Caple Service. The cable must be replaced by Caple Service.
- Wiring of the appliance must be performed by an authorised installer. H05VV-F type supply cable must be used.
- Faulty wiring may damage the appliance. Such damage will not be covered by the warranty.
- The appliance is designed to connect to 220-240V~ if the electrical supply is different than the value given above, call Caple Service immediately.

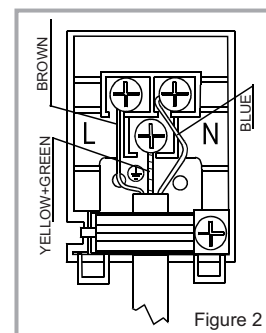

Please keep this instruction manual for future reference



Caple declares that it bears no responsibility whatsoever for any kind of damage and loss arising from not complying with safety norms.

Product description

List of components:

1. Control panel
2. Handle
3. Oven door
4. Lower heating element (behind the plate)
5. Upper heating element (behind the plate)
6. Wire shelf
7. Shelf supports
8. Oven light
9. Turbo heating element (behind the plate)
10. Fan (behind the plate)
11. Air outlet shutters

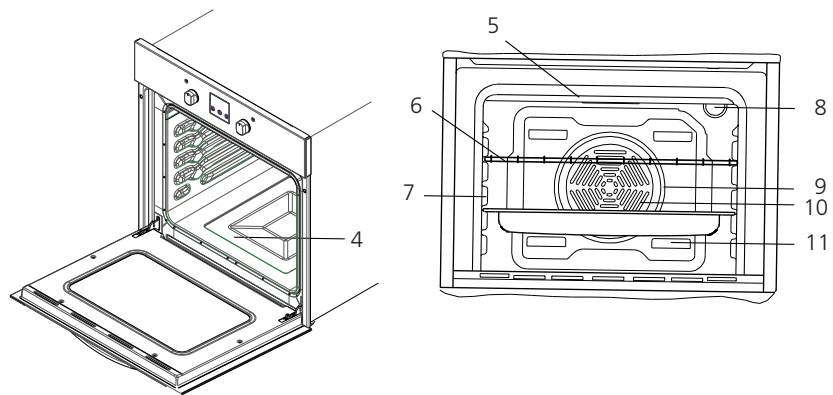
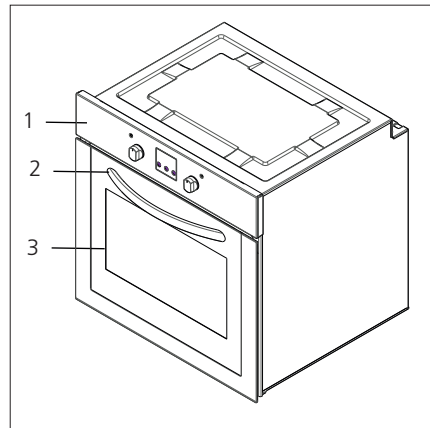

USING THE OVEN

Control panel

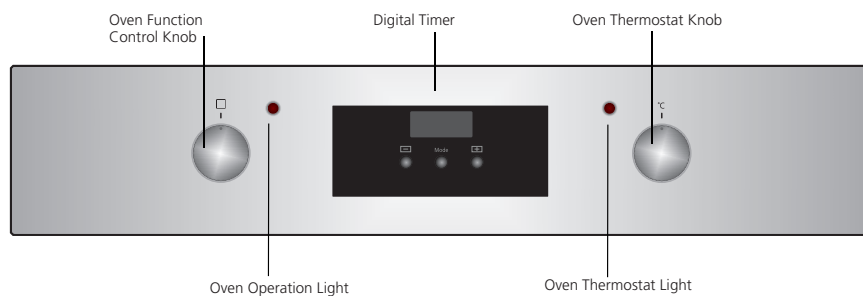

Oven function control knob:

- To select the desired cooking function, turn the knob to the related symbol. Please see page 10 and 11 for cooking functions and a description of each.

Oven thermostat control knob:

- After the cooking function is set, the desired temperature can be adjusted by the oven thermostat knob. The oven will then start to operate (time must be set, if available).
- The thermostat signal light will turn on when the knob is turned to the required temperature. The light will turn off once the oven reaches the required temperature.
- The function symbols and temperature settings are printed on the side of the knob.

Please keep this instruction manual for future reference



Oven functions

OVEN LAMP

Only the oven light will be turned on and it remains on in all the cooking functions.

TURBO DEFROST

The oven's warning lights will be turned on, the fan starts operating.

To use the defrost function, take your frozen food and place it in the oven on a shelf placed in the third slot from the bottom. It is recommended that you can place an oven tray under the defrosting food, to catch the water accumulated due to melting ice. This function will not cook or bake your food, it will only help to defrost it.

FAN HEAT

The oven's thermostat and warning lights will be turned on, the ring heating element and fan will start operating.

The fan heat function evenly disperses the heat in the oven. All foods on all racks will be cooked evenly. It is recommended to pre-heat the oven about 10 minutes.

CONVENTIONAL HEAT

The oven's thermostat and warning lights will be turned on, the lower and upper heating elements will start operating.

The static cooking function emits heat, ensuring even cooking of the lower and upper food. This is ideal for making pastries, cakes, baked pasta, lasagne and pizza. Preheating the oven for 10 minutes is recommended and it is best to cook on only one shelf at a time in this function.

TURBO CONVENTIONAL HEAT

The oven's thermostat and warning lights will be turned on, the upper and lower heating elements and fan will start operating.

This function is very good for obtaining results in baking pastry. Cooking is carried out by the lower and upper heating element within the oven and by the fan providing air circulation, which will give a slight grill effect to the food. It is recommended to pre-heat the oven about 10 minutes.

BASE PLUS FAN HEAT

The oven's thermostat and warning lights will be turned on, the ring and lower heating elements and fan will start operating.

Fan and lower heating function is ideal for baking food, such as pizza, equally in a short time. While the fan evenly disperses the heat of the oven, the lower heating element ensures the baking of food dough.

ECO GRILL

The oven's thermostat and warning lights will be turned on, the grill heating element will start operating.

The function is used for grilling and toasting foods, use the upper shelves of oven. Lightly brush the wire grid with oil to stop foods sticking and place foods in the centre of the grid. Always place a tray beneath to catch any drips of oil or fat. It is recommended to pre-heat the oven about 10 minutes.

WARNING: When grilling, the oven door must be closed and the oven temperature should be adjusted to 190°C.



FULL GRILL

The oven's thermostat and warning lights will be turned on, the grill and upper heating elements will start operating.

The function is used for faster grilling and for covering a larger surface area, such as grilling meats, use the upper shelves of oven. Lightly brush the wire grid with oil to stop foods sticking and place foods in the centre of the grid. Always place a tray beneath to catch any drips of oil or fat. It is recommended to pre-heat the oven about 10 minutes.

WARNING: When grilling, the oven door must be closed and the oven temperature should be adjusted to 190°C.

TURBO GRILL

The oven's thermostat and warning lights will be turned on, the grill and upper heating elements and fan will start operating.

The function is used for faster grilling of thicker foods and for covering a larger surface area. Both the upper heating elements and grill will be energised along with the fan to ensure even cooking. Use the upper shelves of oven. Lightly brush the wire grid with oil to stop foods sticking and place foods in the centre of the grid. Always place a tray beneath to catch any drips of oil or fat. It is recommended to pre-heat the oven about 10 minutes.

WARNING: When grilling, the oven door must be closed and the oven temperature should be adjusted to 190°C.

Use of digital timer

SETTING THE TIME

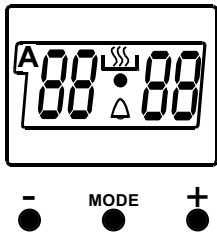





Once the oven has been connected to the mains supply, the clock needs to be set before the oven can be used. Press the MODE button once. The  symbol will appear in the display and the DOT will flash. Press either the + or - to adjust the time. Once you have finished wait 3 seconds. The DOT in the centre of the display will stop flashing. The time is now set.

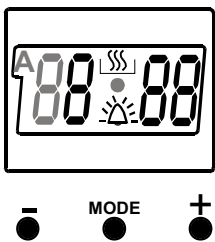

To amend the time, press and hold the + and - buttons simultaneously for 3 seconds. The DOT in the centre will start to flash. Press either the + or - buttons to adjust the time. Once you have finished wait 3 seconds. The DOT in the centre of the display will stop flashing and the time is now set.

SETTING THE ALARM



Press the MODE button in the middle. The  symbol will flash on the screen and three 0's will appear. Adjust the desired time period for the warning by using + and - keys while the  symbol is flashing. Some time after the completion of the adjustment, the  symbol will begin to light continuously. When the  symbol begins to light continuously, the audible alarm is set.

The audible alarm can be set to a time between the time range of 0 and 23.59.

When the time set has come to an end the alarm will sound and the  symbol will flash on the screen. Pressing any key will stop the alarm and the  symbol disappears on the screen.

The audible alarm is for warning purposes only. The oven will not be activated with this function.

SEMI AUTOMATIC COOKING PERIOD

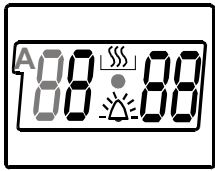

This function is used to cook during a desired time range. The food you wish to cook is placed in the oven.

Turn the function knob to required setting and turn the thermostat to required temperature. Keep pressing on the MODE button until you see 'stop' on the timer screen. When you see 'stop' on the timer screen, 'A' will begin to flash. Adjust the cooking period for the food you wish to cook, by using the + and - buttons while the timer is in position. Once timer is set, the day's time will appear on the screen and 'A' will continuously appear on the screen. While doing this, the oven will also start to operate.

A cooking period between the time range of 0 and 10 hours can be set.

At the completion of the set duration; the timer will stop the oven, the alarm will sound and the 'A' will begin to flash on the screen. After bringing the oven function knob and thermostat knob to 0 position, pressing any button will end the audible alarm. The timer will also return to manual use.

SEMI AUTOMATIC PROGRAMMING ACCORDING TO FINISH TIME

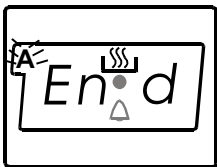

This function is used to cook according to the desired finishing time. The food to be cooked is put into the oven. The oven is adjusted to the desired cooking function. The oven thermostat is adjusted to the desired temperature depending on the dish to be cooked. Keep pressing on the MODE button until you see 'end' on the timer screen, the A and the day's time will respectively begin to flash.

Adjust the finishing time for the food you wish to cook, by using the + and - keys while the timer is in this position. Some time after the adjustment operation is completed, the day's time will appear on the screen and the symbols A and will begin to continuously light on the screen. While doing this, the oven will also start to operate.

You can set a time which can be up to 10 hours after the day's time.

At the completion of the set duration, the timer will stop the oven and give audible warning. Also the symbol A will begin to flash on the screen. After bringing the oven function knob and thermostat knob to 0 position, pressing any button will end the audible alarm. The timer will also return to manual use.



FULLY AUTOMATIC COOKING

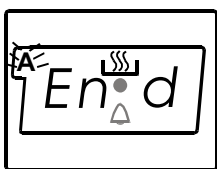
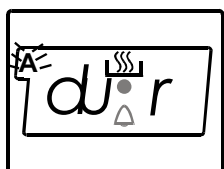

Full Automatic Program Setting (Cooking Period and Finish Time)

1. This feature allows an automatic switching on and off time of the oven at pre-set times.
2. To set the timer to switch on automatically at a pre-set time, press the mode button repeatedly until 'Dur' shows and the 'A' symbol flashes.
3. Without delay after the previous step, press the + or - buttons to select the desired cooking duration period.
4. Set the finish time by pressing the mode button again until the display shows 'End' and the 'A' symbol flashes.
5. Without delay after the previous step, press the + or - buttons to select the desired finish time.
6. After a few seconds the timer will show the time of day and the 'A' symbol will be displayed confirming that the timer has been programmed.
7. Rotate both the oven function and the oven temperature controls to the desired settings.
8. The oven will start cooking at the required time and will switch off automatically at the selected finish time.
9. When the oven switches off automatically, the audible warning signal will be heard. Pressing any of the timer buttons will silence the timer and reset the oven to manual cooking mode.

Recommended cooking times and shelf position

Dishes	Fan heat			Conventional heat			Turbo conventional heat			Grill		
	Temperature (°C)	Rack position	Cooking time (mins)	Temperature (°C)	Rack position	Cooking time (mins)	Temperature (°C)	Rack position	Cooking time (mins)	Temperature (°C)	Rack position	Cooking time (mins)
Pastry	170-190	1-2-3	35-45	170-190	1-2	35-45	170-190	1-2	25-35			
Cakes	150-170	1-2-3	30-40	170-190	1-2	30-40	150-170	1-2-3	25-35			
Cookies	150-170	1-2-3	25-35	170-190	1-2	30-40	150-170	1-2-3	25-35			
Grilled meatballs										200	4	10-15
Chicken				200	1-2	45-60	200	1-2	45-60	200	3-4	50-60
Pork chop										200	3-4	15-25
Beef steak										200	4	15-25
Two tray cakes	160-180	1-4	30-40									
Two tray pastry	170-190	1-4	35-45									

Please keep this instruction manual for future reference



Accessories in the oven

- It is recommended that you use the accessories supplied with the oven to cook food.
- You can also use glass containers, cake cutters, special oven trays suitable for use in your oven. Pay attention to any information given by the manufacturer of these accessories.
- If small sized containers are used, place in the centre of the shelf.
- The information given below should be implemented for enamelled containers.
- Deformation may be observed on the tray due to high temperatures forming during the cooking. This is a normal result due to the heat transfer, this is more prevalent if:
 - The food you are cooking does not completely cover the oven tray
 - The food is frozen
 - The tray is used to collect the dripping juices of food during the grill operation.
- Do not leave a glass tray or container in a cold environment immediately after cooking in them.
- Do not put hot trays on cold or wet surfaces.
- Ensure that they slowly cool off placing them on a dry piece of cloth. Otherwise, the glass tray or container might break.
- If you are using the grill, we recommend that use it with the tray supplied with your product. This way, splattering and dripping oils will not make the oven interior dirty.
- If you are going to use the large wire shelf, insert a tray into one of the lower racks to avoid accumulation of the oils. To make cleaning easier, add some water into it as well. In a grilling operation, use the third or fourth rack to prevent the food sticking to the grill.

Shelf positions

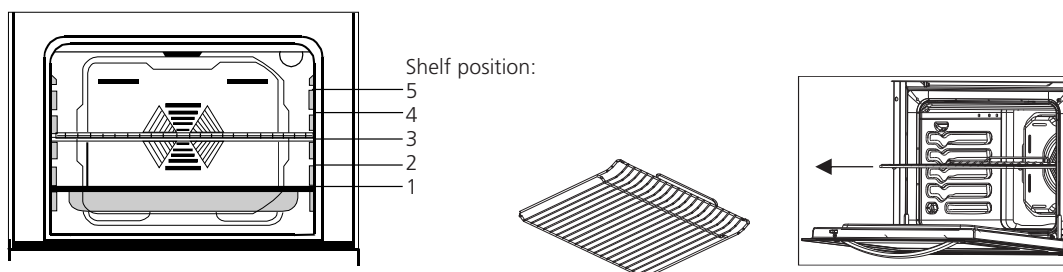

The wire shelf should be used to grill or place different cookware on.

Warning

Fit the wire shelf correctly into any corresponding rack in the oven cavity and push all the way back into the oven.



Removal of wire shelf supports

- Pull the wire shelf support as shown in the picture.
- After releasing it from clips, lift it up.

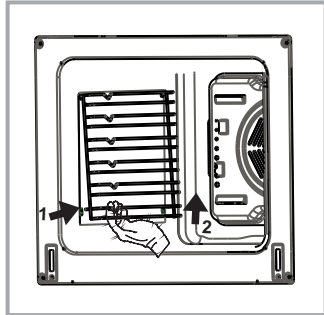

Tray, wire grid and handle set

Grill pan set is for use when grilling steaks etc.

Warning:

The grill pan has a detachable handle. Ensure when using the grill pan handle that it is centralised and secure as shown in the picture. Use the grill pan handle by two hands. Do not leave the handle in position when grilling.

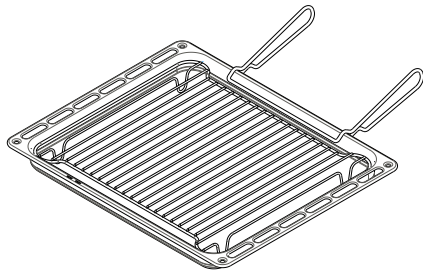

CLEANING AND MAINTENANCE

- Before starting to clean your oven, be sure that all control buttons are off and your appliance is cool. Unplug the appliance.
- Do not use cleaning materials containing particles that may scratch the enamelled and painted parts of your oven. Use non-abrasive cleaning products only.
- Do not use caustic creams, abrasive cleaning powders, rough wire wool or hard tools as they may damage the surface.
- If excess liquids spill onto the oven it may burn and cause permanent damage to the product. Immediately clean up the spilt liquids.

Do not use steam cleaners for cleaning the oven.

Cleaning the interior of the oven

- Make sure to unplug the oven before starting to clean it.
- To achieve the best results clean the interior while the oven is slightly warm.
- Wipe your oven with a soft, damp cloth with soapy water after each use. Then wipe it again, this time with a wet cloth, and wipe it dry.

Replacing the oven lamp

- The change of oven lamp must be done by an authorised technician.
- The rating of the bulb should be 230V, 25W, Type E14, T300.
- Before changing the lamp, the oven should be switched off and it should be cool.
- The lamp design is specific for the use in a household cooking appliance and it is not suitable for lighting a room.

TROUBLESHOOTING

The oven does not operate	<ul style="list-style-type: none"> Check it is switched on at the mains There has been a power cut The time is not set
The oven does not heat	The thermostat is not turned to a temperature
The interior lamp does not light	<ul style="list-style-type: none"> Check the product is connected to the electrical supply and is switched on Replace the bulb
Lower and upper parts of the oven are not cooking evenly	Control the shelf location, cooking period and temperatures according to the manual

If you still experience any problems with your appliance please contact Caple Service on 0117 938 7420 or email service@caple.co.uk

TRANSPORT

If you need to transport the oven:

- Keep the original packaging
- Follow the transport symbols on packaging
- Remove all accessories including shelves, pans and handle to avoid damaging the product

If the original packaging is not available:

- Ensure oven is secure and the external parts are well protected to avoid any damage.

Brand		
Model		C2236
Type of oven		Electric
Mass	kg	33
Energy efficiency index – conventional		112.7
Energy efficiency index – fan heat		103.6
Energy class		A
Energy consumption (electricity) – conventional	kWh/cycle	0.98
Energy consumption (electricity) – fan heat	kWh/cycle	0.87
Number of cavities		1
Heat source		Electric
Volume	l	69
This oven complies with EN 60350-1		

Energy saving

- Cook different meals together when possible
- Keep pre-heating time as short as possible
- Do not extend cooking time unnecessarily
- Do not forget to turn off the oven at the end of cooking
- Do not open the oven door during cooking period

Please keep this instruction manual for future reference



Please keep this instruction manual for future reference





Please keep this instruction manual for future reference





Caple Service
Fourth Way
Avonmouth
Bristol
BS11 8DW

t: 0117 938 7420
e: service@caple.co.uk
www.caple.co.uk

Please keep this instruction manual for future reference

