



1MINCHP5

Caple 1 Motor Integrated Extractor



INSTRUCTION
MANUAL

■ TABLE OF CONTENTS

✳

Contents

1. Installation	P1~3
2. Safety & Cleaning	P4~5
3. Alternative Methods Of Extraction	P6
4. Operation	P7
5. Fitting Charcoal Filter / Bulb Replacement	P8
6. Electrical Connections	P9
7. Not Working Properly	P12
8. Technical Data	P12

General description

The extractor is designed to give you the option to extract to the outside (via an exterior wall) with ducting, or to re-circulate air through additional filters to minimise odours, steam and condensation.

The choice is yours to decide at installation, Both options are explained in this booklet.

We recommend that you read this booklet from cover to cover before attempting to install or operate the extractor.

Installation

THESE INSTRUCTIONS MUST BE STRICTLY ADHERED TO, FAILURE TO COMPLY COULD RESULT IN OVERHEATING AND SERIOUS DAMAGE TO YOUR APPLIANCE

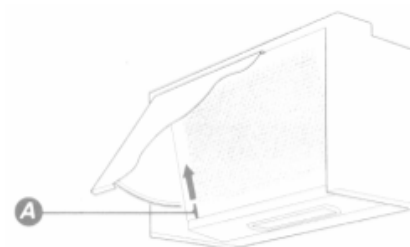

To secure the product to the wall you must initially remove the grill/anti-grease filters. This is achieved by opening the front panel and pushing the two catches (A) upwards which will then release the grill.

Installation cont.

Once the grill has been removed, The front door panel should also be removed.

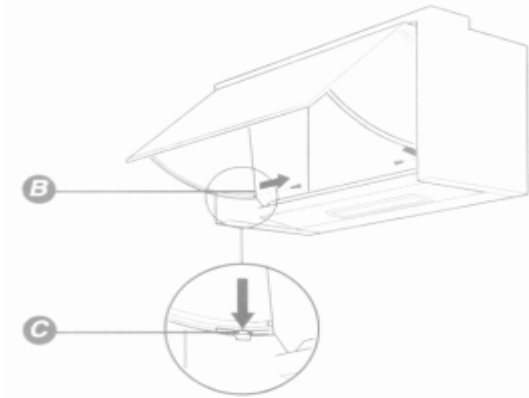

Open the front panel and remove the two screws (B) as illustrated above. Press the tab (C) down and remove the front panel from its guides

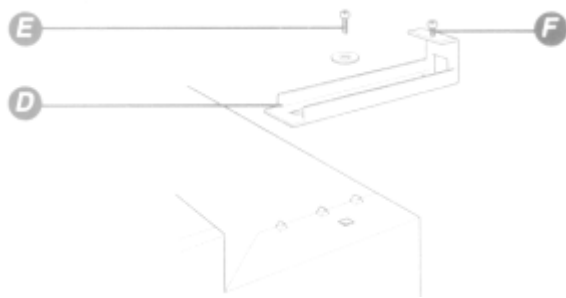

Secure brackets(D) onto the top of the extractor using the fitting screws and washer (E). Check that adjustment screw (F) is fitted. Note: Note some units may have bracket fitted.

Installation cont.

Ensure there is a minimum distance of 700mm between the bottom of the extractor and the hob surface. (See installation guides for other hob makes). Then fix the two mounting brackets (G) to the rear wall. Once the two mounting brackets are in position, hook the extractor mounting bracket (D) onto the wall mounting bracket. Some adjustment is provided within the brackets. For forward and backward adjustment use screw (E) and for height alignment, adjust screws (F).

Once the adjustment is complete fully tighten all screws.

If after installation there is a gap between the rear wall and the extractor a spacer is provided. This can be fixed to the rear of the extractor and cut to accommodate the gap.

IMPORTANT NOTE: After the extractor has been positioned correctly the extractor must be fixed to the adjacent cabinets through the fixing holes in the sides of the extractor.

All that remains is to fix the front wooden door panel to the extractor by using the diagram below, then fix the front panel.

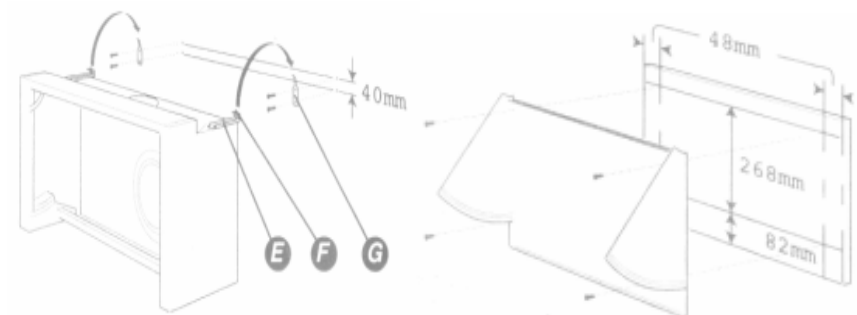

Electrical Safety

Before you think about fixing, give careful consideration to the power connection. It is vital that the supply cable should be well shielded from your grill, hob or oven. If it isn't, heat from any one of these sources may damage the cable insulation and give rise to a fire risk. Under no circumstances should the exposed power supply cable come within 70cm of a direct source of heat, Ideally it should be channeled into the wall, well out of harm's way.

For Your Safety

In order to protect your appliance and minimise the risk of fire, don't barbecue food directly under the extractor. Similarly, do not prepare flambé dishes immediately under the extractor. Your extractor is designed to draw gases up and away from your hob. This means that exposed flames may behave unpredictably in the vicinity of the appliance while it is switch on. When frying take particular care to prevent the oil from catching fire and never leave unattended.

Cleaning

IMPORTANT: Before attempting any cleaning or maintenance, ensure your extractor is disconnected from the power source.

GENERAL CLEANING: Regular and thorough maintenance guarantee will provide long lasting operation.

Wipe the external surface of the appliance regularly using warm water and a mild detergent, never use products containing abrasive.

Cleaning

Particular care must be paid to the grease filtering panels which must be periodically cleaned in relation to use (at least once every two months)

Alternative Methods Of Extraction

1. Extraction Via Ducting (fig.1)

The very best method of cleaning the kitchen of unwanted odours is by connecting the appliance to an exhaust duct and venting to the outside atmosphere via an exterior wall (suitable ducting kits may be purchased from the store where you buy your extractor.) Ducting your extractor negates the need for charcoal filters.(Fig.1)

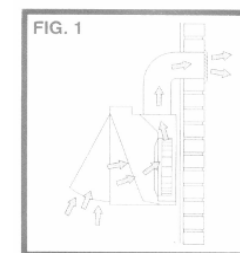

FIG. 1
DUCTING MODE
(NO CHARCOAL FILTER REQUIRED)

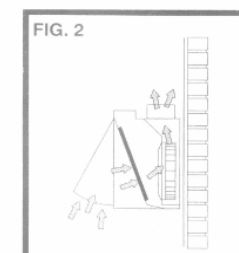

FIG. 2
RECIRCULATING MODE
(CHARCOAL FILTERS REQUIRED)

Remember: Before drilling or chiseling the wall, check for pipes and power cables.

1. Ensure the ducting tube is kept as short as possible and with minimum of bends to permit smooth airflow. (Maximum length 3M)

Alternative Methods Of Extraction

2. Ducted air must not be discharged into a flue which is used for exhausting fumes from appliances supplied with any energy other than electricity.
3. Ensure the requirement of the local authorities are adhered to concerning the discharged of exhaust air.
4. Ensure adequate room ventilation is provided when the extractor is used in the same room as appliances supplied with energy other than electricity.
5. Never duct into a hot air flow such as a central heating duct.

We strongly advise that all exterior outlets be fitted with a **non return valve with louvered slotting.**

2. The Re-circulation Mode (Fig.2)

When there is no easy access to an outside wall, the extractor can easily be adapted to clean air polluted by cooking smells, by using a charcoal filter which can be purchased from the store where you buy your extractor. Remember the re-circulation mode cannot be used without charcoal filters.

The Charcoal Filter CAP20CF

Filters do have a limited life. We advise you to change it when there is a noticeable drop in performance. The intervals between changing the filter will depend entirely upon the amount of cooking you do. But on average they will last about 6 months.

Alternative Methods Of Extraction

The Grease Filter Mat

The grease filter mat on model 1MINCHP5 requires replacing or cleaning every 3 months. The filter can be cleaned in a dishwasher or washed with a neutral detergent. To gain access to the grease filter mat, the charcoal filter must be removed.

IMPORTANT: You should never attempt to use the extractor without the grease filter as grease build-up could prevent the motor working properly. If either filter is not supplied pull out the plug before changing the filters.

Operation Your Extractor

The motor will automatically operate by opening and closing the front door panel as long as the switch is set accordingly. The extractor fan has three speed settings for light, medium or heavy extraction of cooking vapours. The different levels of extraction are numbers 1 ,2 and 3 and can be recognised by the changes in noise level of the extractor fan when operating.

To switch on the light simply move the switch to position 1.

NOTE: The light is not effected by opening or closing the front panel.

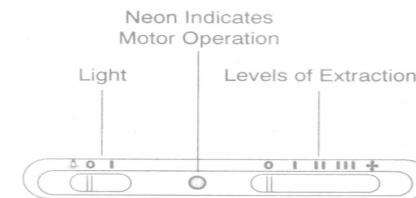

Alternative Methods Of Extraction

To change the Charcoal Filter remove the flexible wire frame and simply replace with a new filter as shown below.

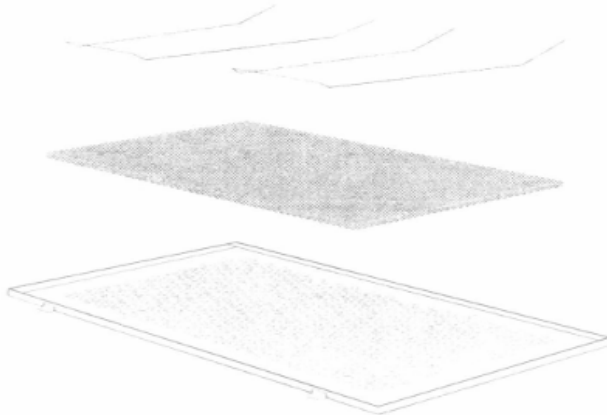

Bulb Replacement

To replace a bulb simply remove the grill and unscrew the bulb. Replace with one of the identical type.

Note: The bulb is not covered by the guarantee.

Always switch off the electricity supply prior to changing the bulb.

Electrical Connections

IMPORTANT: ENSURE THAT THE ELECTRICITY SUPPLY IS SWITCHED OFF BEFORE CONNECTING.

Your appliance must be connected to fix wiring via the use of a double pole switched fused spur outlet with at least 3 mm contact separation, and preferably with a pilot lamp. (See technical data for fuse rating). We strongly recommend the appliance is connected by a qualified electrician

NOTE: The terminology “DOUBLE POLE” means that both the live and neutral supplies are switched and disconnected at the same time.

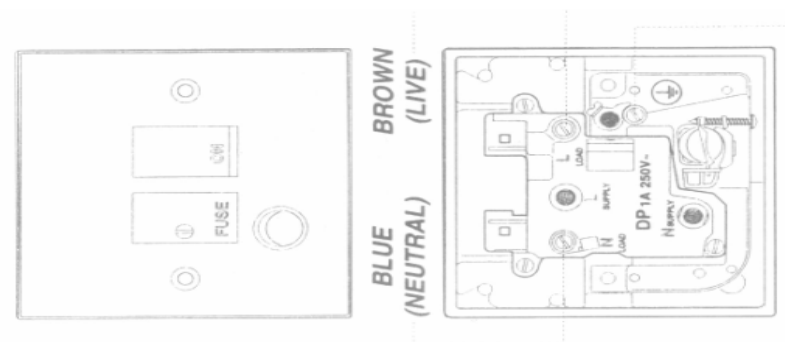

The terminations labeled SUPPLY are for the connection for the internal house wiring and the terminations labeled LOAD are for connection for the appliances.

Electrical Connections

Important:

The wires in this mains lead are coloured in accordance with the following code:

Blue	Neutral
Brown	Live

As the colours of the wires in the mains lead of this appliance may correspond with the colours markings identifying the terminals in your spur box, proceed as follow:

The wire which is coloured blue must be connected to the terminal which is marked with the letter "N" or coloured black. The wire which is coloured brown must be connected to the terminal which is marked with the Letter 'L' or coloured red.

WARNING

This appliance has such technical particulars that it belongs to Class 2 insulation and therefore neither wire should be connected to the terminal marked with the letter E or by the earth symbol.

Not working Properly ?

Light bulb doesn't come on

A replacement is probably necessary, But check first that the bulb is firmly screwed in to its holder. If the filament is broken, remember that the light bulbs are not covered by our guarantee. Remember to disconnect power supply before removing the bulb.

Motor is on but fan doesn't seem to be as efficient as usual

Check grease filter mat. If it hasn't been cleaned recently, It might be clogged with grease. If the filter mat is relatively clean, check the charcoal filter. If this hasn't been replaced for more than six months., remove it and insert a new one.

Works normally but cooking smells linger

If you're using the unit in re-circulation mode, change the charcoal filter. It is obviously past its prime.

Controls fail to switch motor on

Check plug, socket and fuse. If these are in order and fault persists, it could be that an accumulation of grease has impaired the efficiency of the switch mechanism. Try rapidly moving switch

Not Working Properly ?

on and off several times in succession to clear grease deposit. If fault continues, call service agent.

Appliance does not work at all

Check your extractor is switched on at the mains. Next, check out for an unexpected power failure by switching on adjacent lights etc.

Still not working? Call the service agent

If, having consulted the above diagnostic chart you are still unable to remedy the situation, please call 0870 2411 142.

Technical Data

Voltage	220V~240V / 50Hz
Rotation method	Single Motor
Rated motor input power	120W
Illumination	≤25W
Rated input power	145W
Suction power	330 m3/h
Noise	≤61dBA
Outlet diameter	120mm