



# Classic built-under electric double oven instruction manual

## C4245



Contact Caple on 0117 938 7420 or for spare parts [www.caple.co.uk](http://www.caple.co.uk)





## CONTENTS

Safety instructions	3
Environmental protection	9
Oven installation	11
Using your oven	16
Cooking guidelines	18
Touch control electronic timer	21
Care and maintenance	24
Troubleshooting	30
Caple Service contact details	32

Please keep this instruction manual for future reference



## SAFETY INSTRUCTIONS

Read these instructions carefully and completely before using your appliance, keep it in a convenient place for reference when necessary.

- This appliance can be used by children aged from 8 years and above.
- Persons with reduced physical, sensory or mental capabilities or lack of experience and knowledge must be supervised and given appropriate instruction concerning the use of the appliance in a safe way and understand the hazards involved.
- Children shall not play with the appliance.
- Cleaning and user maintenance should not be carried out by children without supervision.
- The appliance is not intended to be operated by means of an external timer or separate remote control system.

### WARNING:

- The appliance and its accessible parts become hot during use. Care should be taken to avoid touching heating elements.
- Children less than 8 years of age should be kept

Please keep this instruction manual for future reference

Instruction manual C4245 3





away unless continuously supervised.

- To prevent fire hazards do not store items on the cooking surfaces.
- If the surface is cracked, switch off the appliance to avoid the possibility of electric shock.

### **WARNING:**

- During use, handles can get hot.
- Do not use harsh abrasive cleaners or sharp metal scrapers to clean the oven door glass or any other surface of the appliance as it can scratch the surface which may result in the glass shattering or permanent damage to the surface.
- Do not use steam cleaners for cleaning the appliance.
- Ensure the appliance is switched off before replacing the lamp to avoid the possibility of electric shock.

### **CAUTION:**

- Accessible parts may be hot when the cooking or grilling is in use. Young children should be kept away.
- Your appliance is produced in accordance with all

Please keep this instruction manual for future reference





applicable local and international standards and regulations.

- Maintenance and repair work must be made only by authorised Caple service technicians. Installation and repair work that is carried out by unauthorised technicians may endanger you.
- It is dangerous to alter or modify the specifications of the appliance in any way.
- Prior to installation, ensure that the local distribution conditions (electricity voltage and frequency) and the requirements of the appliance are compatible. The requirements for this appliance are stated on the rating label.
- This appliance is designed only for cooking food and is intended for indoor use.
- This product is not designed for commercial use, it is a household appliance only. It is not intended to be used in:
  - Staff kitchen areas in shops, offices and other working environments.
  - Bed and breakfast type environments
  - By clients in hotels, motels and other residential type environments
- Do not try to lift or move the appliance by pulling the door handle.

Please keep this instruction manual for future reference



- All possible security measures have been taken to ensure your safety. Since the glass may break, you should be careful while cleaning to avoid scratching.
- Avoid hitting or knocking on the glass with accessories.
- Ensure that the supply cord is not wedged during the installation. If the supply cord is damaged, it must be replaced by a Caple service technician or similarly qualified persons in order to prevent a hazard.
- While the oven door is open, do not let children climb on the door or sit on it.

## **INSTALLATION WARNINGS**

- Do not operate the appliance before it is fully installed.
- The appliance must be installed by an authorised technician.
- Caple is not responsible for any damage that may be caused by defective placement and installation by unauthorised persons.
- When unpacking the appliance, make sure that it is not damaged during transportation. In the case of any defect; do not use the appliance and

Please keep this instruction manual for future reference





contact your retailer or Caple Service immediately.

- Materials used for packaging (nylon, staplers, styrofoam etc) may cause harmful effects to children they should be disposed of immediately.
- Protect your appliance against atmospheric effects. Do not expose it to effects such as sun, rain, snow etc.
- The surrounding materials of the appliance (i.e. kitchen cabinet or furniture) must be able to withstand a minimum temperature of 120°C.

## **DURING USAGE**

- Heat the empty oven at max. temperature for 1 hour before its first use. This removes any unpleasant smells and smoke caused by working residues and thermal insulation. Make sure you do this in a well ventilated area.
- During usage, the outer and inner surfaces of the oven get hot. While opening the oven door, step back to avoid the hot steam coming out of the oven as there may be a risk of burns.
- Do not put flammable or combustible materials in or near the appliance when it is operating.
- Always use oven gloves to remove and replace food in the oven.
- Pay attention to the oven while cooking with solid or liquid oils as they could potentially catch fire when oven is hot.

Please keep this instruction manual for future reference



- Never pour water on flames that are caused by oil. Cover the saucepan or frying pan with its lid in order to choke the flame and turn the oven off.
- If you know you will not be using the appliance for a while switch it off from the main supply and unplug it.
- Make sure the appliance control knobs are always in the '0' (stop) position when it is not used.
- The oven shelves and trays incline when pulled out. Be careful not to let hot liquid spill over.
- When the door of the oven is open, do not leave anything on it. It may unbalance your appliance or damage the door.
- Do not put anything heavy, flammable or ignitable (nylon, plastic bag, paper or cloth etc) into the oven. This includes cookware with plastic accessories (e.g. handles). Do not hang towels or clothes from the appliance or its handles.

## INDICATOR LIGHTS

- The indicator lights above the control panel go on/off when the heating elements are inserted or removed. During the thermostatic functioning of the oven, the neon light remains on until the pre-chosen temperature is reached and when it goes out, this is a sign that the temperature has been reached. When the oven cools, the thermostat determines the re-insertion of the heating elements with consequent re-lighting of the indicator lights. The internal oven light is always on when any function is in operation.

Please keep this instruction manual for future reference





## DURING CLEANING AND MAINTENANCE

- Always switch off the appliance from the mains isolating the electrical supply before any cleaning or maintenance.
- Do not remove the control knobs to clean the control panel.

To maintain the efficiency and safety of your appliance, we recommend you always use original spare parts and to call only our authorised Caple Service agents in case of need.

## ENVIRONMENTAL PROTECTION



Waste electrical products should not be disposed of with household waste. Please recycle where facilities exist. Check with your Local Authority or retailer for recycling advice.

This appliance is marked according to the European directive 2002/96/EC on Waste Electrical and Electronic Equipment (WEEE). By ensuring this product is disposed of correctly, you will help prevent potential negative consequences for the environment and human health, which could otherwise be caused by inappropriate waste handling of this product. The symbol on the product indicates that this product may not be treated as household waste. Instead it shall be handed over to the applicable collection point for the recycling of electrical and electronic equipment. Disposal must be carried out in accordance with local environmental regulations for waste disposal.

For more detailed information about treatment, recovery and recycling of this product, please contact your local council, your household waste disposal service or the retailer where you purchased the product.

## WARRANTY

Your new appliance is covered by warranty. The warranty card is enclosed - if it is missing, you must provide the following information to your retailer in order to receive a replacement: date of purchase, model and serial number (placed on the inside of the appliance storage drawer). Registration can also be completed online by visiting [www.caple.co.uk](http://www.caple.co.uk).

Please keep this instruction manual for future reference



Ensure you keep your warranty card safe, you may need to show it to Caple Service together with proof of purchase.

If you fail to show your warranty card you will incur all repair charges.

Spare parts are only available from Caple Service and spare parts authorised centres.

## **ATTENTION**

- Before use, remove all plastic films protecting some parts of the appliance (fascia - panel, parts in stainless steel, etc)
- Do not use the appliance to heat a room.
- When the appliance is not in use, we recommend you turn it off, isolate it from the electrical supply and ensure all gas taps are closed.

## **CE DECLARATIONS OF CONFORMITY $\text{C} \text{E}$**

This appliance has been designed, constructed and marketed in compliance with safety requirements in force. This appliance has been manufactured to the strictest standards and complies with all applicable legislation.

Please keep this instruction manual for future reference





## OVEN INSTALLATION

Please check the following before installation:

- The panels of the adjoining furniture should be heat resistant. Particularly when the adjoining furniture is made of veneered wood, the adhesives should be able to withstand a temperature of 120°C. Plastic materials or adhesive which cannot withstand this temperature will become deformed or unstuck.
- To comply with safety regulations, once the appliance has been fitted it should not be possible to make contact with the electrical parts.
- All parts which offer protection should be fixed in such a way that they cannot be removed without the use of a tool.
- Ensure that the appliance is switched off before replacing the lamp to avoid the possibility of electric shock.

### IMPORTANT:

- Ensure the oven is disconnected from the mains prior to installation.
- Installation should be carried out according to the instructions by a professionally qualified person. Caple cannot accept responsibility for any damage to persons, animals or other items due to incorrect installation.
- Position and secure the support brackets into the adjacent carcasses (see Fig.2).
- Position the oven onto the support brackets supplied.
- Secure the appliance into its surround by inserting screws into the 4 holes that can be seen in the frame of the oven when the door is open (Fig.1).

Fig.1

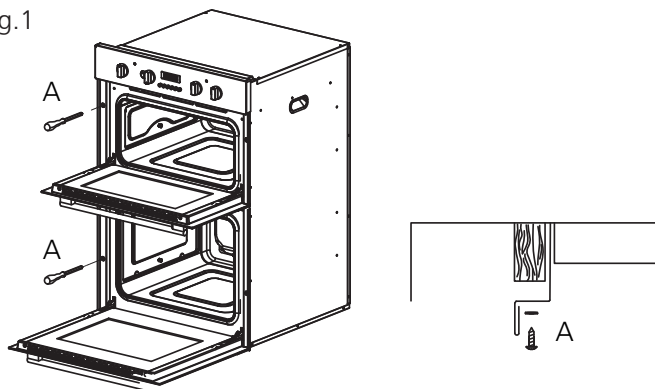

Please keep this instruction manual for future reference



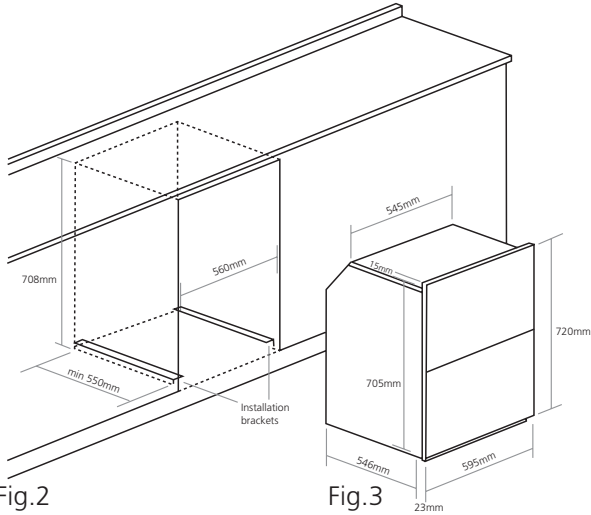
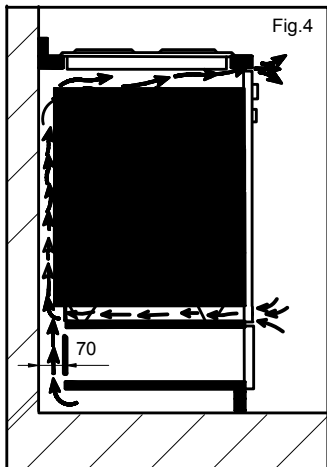

Fig.2

Fig.3

- For the most efficient air circulation, the oven should be fitted according to the dimensions shown in Fig.2 and Fig.3
- An opening of atleast 70mm must be cut at the bottom of the unit to ensure adequate ventilation (see Fig.4).



Please keep this instruction manual for future reference





## Connection to the mains supply

### **WARNING:**

This appliance must be earthed

- Check that the power rating of the mains supply and of the sockets are suitable for the maximum power of the appliance as indicated on the rating plate.
- The plug should be accessible after installation. Fit the plug into a socket fitted with a third contact which corresponds with the earth connection. This should be properly connected.

If the appliance is fitted with supply leads but not connected to a plug, you must permanently connect to fixed wiring as follow:

- The yellow/green earth wire, which must be connected to terminal, has to be approximately 10mm longer than the other wires; the blue neutral wire has to be connected to the terminal marked with letter N.
- Black, brown, red live wires have to be connected to terminal L. Mains connection can also be made by fitting double pole switch with a minimum gap between the contacts of 3mm, proportionate to the load and complying with the regulations in force.
- The yellow/green earth wire should not be controlled by the switch.
- The plug or a double pole switch used for mains supply connection should be easy to get at, once the appliance is in position.

Please keep this instruction manual for future reference

Instruction manual C4245 13



## IMPORTANT:

- Position the mains supply cable so that it is never subjected to a temperature which is more than 50°C above ambient temperature.
- The electrical safety of the appliance can only be guaranteed when it has been correctly connected to an efficient earthed power supply, as instructed in the regulations for electrical safety.
- Caple cannot be held responsible for any damage to persons or objects due to lack of an earth connection.

## Electrical connection

### Fitting the power supply cable

- Open the terminal box by inserting a screwdriver into the side tabs of the cover. Use the screwdriver as a lever by pushing it down to open the cover
- Install the power supply cable by loosening the cable clamp screw and the three wire contact screws. Connect the wires to the corresponding terminals: the Blue wire to the terminal marked 'N', the Brown wire to the terminal marked 'L' and the yellow/green wire to the terminal marked  $\oplus$ .
- Secure the cable by fastening the clamp screw.
- Close the cover of the terminal box.
- When wiring the terminal box care must be taken to fit and tighten the links on the live (L) and neutral (N) terminals

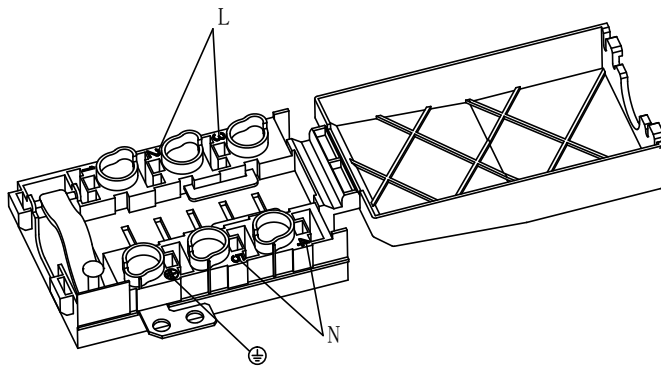

Please keep this instruction manual for future reference





## Wiring and safety

The instructions given below MUST be adhered to during wiring:

- This appliance is designed to connect to 220-240V~ and is rated at 20Amps and as such needs to be hard wired to the electrical supply.
- If the electrical supply is different from the value given above, call Caple Service immediately.
- Wiring of the appliance must be performed by a qualified installer/electrician.
- The earth cable must be connected via the terminal screw with the earthing mark. Supply cable connection must be as shown in the diagram. If there is no earthed outlet conforming to regulations in the installation environment, the installation cannot go ahead and an Electrician should be consulted immediately.
- The installation must include a suitable isolating switch with a minimum contact opening of 3mm between the appliance and the mains. The isolating switch should be sized according to the load on the rating plate "20Amp" and should comply with current regulations.
- The earthed outlet must be in close vicinity of the appliance. Never use an extension lead.
- The supply cable should not make contact with the product's hot surface.
- In case of any damage to the supply cable, please call Caple Service. The cable must be replaced by a qualified installer/electrician)
- Faulty wiring may damage the appliance. Such damage will not be covered by the warranty.
- When wiring the terminal box care should be taken to fit and tighten the links on the live and neutral terminals

Please keep this instruction manual for future reference

Instruction manual C4245 15



## USING YOUR OVEN

### Control panel

#### Top oven 4 functions / main oven 8 functions



#### Top oven functions

CONVENTIONAL HEAT

Both the lower and upper heating elements operate together.

This is the traditional cooking method, perfect for roasting joints, cooking pastry and baking cakes.

BASE HEAT

This function is good for cooking the underside of food, warming up food or sterilising glass jars. It is also ideal for slow cooking food, i.e. casseroles. This function can be used between 50°C and MAX.

TOP HEAT

This function can be used for warming pre-cooked food when placing the grid on the second shelf from the top. Or for defrosting pastry, place on grid on the bottom shelf.

FULL GRILL

This function can be used for grilling and gratinating food. When grilling, the oven door must be closed.

#### Bottom oven functions

LIGHT

Internal oven light

Please keep this instruction manual for future reference





## CONVENTIONAL HEAT

Both the lower and upper heating elements operate together.

This is the traditional cooking method, perfect for roasting joints, cooking pastry and baking cakes.

## TURBO DEFROST

The air at ambient temperature is distributed inside the oven to speed up defrosting time.

## FAN HEAT

The fan evenly distributes the hot air (between 50°C and MAX) inside the oven. This is ideal for cooking several types of food i.e. meat and fish at the same time without affecting taste and smell. It is also ideal for delicate pastries.

## TURBO BASE HEAT

Both the fan and the lower heating element operate together.

The air which is heated by the lower heating element is circulated by the fan helping to distribute the heat between 50 and 200°C. This function can be used for sterilising glass jars.

## BASE HEAT

This function is good for cooking the underside of food, warming up food or sterilising glass jars. It is also ideal for slow cooking food, i.e. casseroles. This function can be used between 50°C and MAX.

## TOP HEAT

This function can be used for warming pre-cooked food when placing the grid on the second shelf from the top. Or for defrosting pastry, place on grid on the bottom shelf.



## TURBO CONVENTIONAL HEAT

This function is very good for obtaining results in baking pastry. Cooking is carried out by the lower and upper heating element within the oven and by the fan providing air circulation, which will give a slight grill effect to the food. It is recommended to pre-heat the oven about 10 minutes.

Please keep this instruction manual for future reference

## COOKING GUIDELINES

- Set the function for the type of cooking required.
- Preheat the oven, setting the thermostat to the required temperature. Once the oven has heated to the selected temperature, the orange warning light will go out.
- This same light will appear again automatically during operation of the oven to indicate that the heating elements are on.
- Remove the drip tray when using the oven for conventional cooking, roasting etc. The tray should be left in place only when using the grill, as its purpose is to catch falling droplets of fat. Food should be placed in oven dishes with raised edges and positioned centrally under the grill.
- If the fan heat operation is selected, different foods can be cooked simultaneously (e.g. meat and fish), although in this case the respective cooking time must be observed.

COOKING FUNCTION	FOOD TYPE	SHELF POSITION	TEMPERATURE (°C)	TIME (mins)	
Conventional cooking 	Yorkshire Pudding	1	200	30-40	
	Sponge Cake	1	180	25-30	
	Small Cakes	2	190	15-20	
	Fruit Tart	1	200	40-45	
	Scones	2	220	10-15	
	Fruit Cake	1	140	120-180	
Grilling (Top oven) 				Side 1	Side 2
	Pork chops (4 pcs)	3	225	12	10
	Sausages (6 pcs)	3	225	6	5
	Toast (6 pcs)	3	225	1	1

Please keep this instruction manual for future reference



## Temperatures and times for main oven cooking

DISHES	TEMPERATURE (°C)		TIME (mins)
	□	⊕	
<b>SWEET</b>			
Short pastry flan	200	190	8-10
Fruit pie/tart	200	190	25-35
Shortcake biscuits	200	190	10-15
Savoury biscuits	200	190	15-20
<b>MEAT</b>			
Slow roast	175	170	12-15
Quick roast	200	190	12-15
Meat loaf	200	190	30-40
<b>POULTRY</b>			
Duck 1.5-2kg	200	170	120-180
Goose 3 kg	200	180	150-210
Roast chicken	200	190	60-90
Turkey 5kg	175	150	240
<b>GAME</b>			
Hare	200	180	60-90
Haunch of venison	175	175	90-180

- Frozen meat should be thoroughly thawed before cooking. For large joints it is advisable to thaw overnight.
- Frozen poultry should be thoroughly thawed before cooking, the time required depends on the size of the bird e.g. a large turkey may take up to 48 hours to thaw.
- Adjust the shelf position so the meat or poultry will be in the centre of the oven.
- The times given in the roasting guide are only approximate because the size and age of the bird will influence cooking times as will the shape of a joint and the proportion of bone.

Please keep this instruction manual for future reference



## Roasting guide

COOKING IN OVEN 180°C FAN HEAT 200°C CONVENTIONAL HEAT		TIME
Beef	Rare	20 minutes per 450g (1lb) plus 20 minutes
	Medium	25 minutes per 450g (1lb) plus 20 minutes
	Well done	30 minutes per 450g (1lb) plus 30 minutes
Lamb	Medium	25 minutes per 450g (1lb) plus 25 minutes
	Well done	30 minutes per 450g (1lb) plus 30 minutes
Pork		35 minutes per 450g (1lb) plus 35 minutes
Fowl		20 minutes per 450g (1lb) plus 20 minutes

### Note:

- If you are cooking a very large turkey, we recommend that it is turned around halfway through cooking, so that both legs will be cooked evenly.
- Remove any excess fat from the tin before turning, to prevent any fat splashing.
- When cooking stuffed meat or poultry calculate the cooking time from the total weight of the meat plus the stuffing.
- For joints cooked in foil and for lidded casseroles, add 5 minutes per 450g (1lb) to the calculated cooking time.
- Smaller joints weighing less than 1.25 kg (2lb) may require 5 minutes per 450g (1lb) extra cooking time.

Please keep this instruction manual for future reference















## TOUCH CONTROL ELECTRONIC TIMER

### Setting and changing the current time

#### Note:

The oven only operates when the time has been set.



	<p>When the appliance has been connected to the electrical supply or when there has been a power cut, the time indicator  flashes automatically.</p> <p>To change the time that has already been set, press the time button  repeatedly, until the time indicator  flashes</p> <p>Set the current time using the – or + button After approx. 5 seconds, the flashing stops and the clock displays the time of day set.</p> <p>The appliance is now ready to use</p> <p>The time can only be changed if neither of the automatic functions (cook time  or end time ) have been set.</p>
<h4>TIMER FUNCTIONS</h4>	
<p>Countdown </p>	<p>To set a countdown, a signal sounds after the time has elapsed. This function does not affect the operation of the oven.</p>
<p>Cook time </p>	<p>To set how long the oven is to be in use.</p>
<p>End time </p>	<p>To set when the oven is to switch off again.</p>
<p>Time </p>	<p>To set, change or check the time.</p>

Please keep this instruction manual for future reference











## How to use the clock function

- When a function has been selected, the corresponding function indicator flashes for approx. 5 seconds. During this time the desired times can be set using + or – button.
- When the desired time has been set, the function indicator flashes for approx. another 5 seconds. After that the function indicator is then lit. The set time begins to run.
- Press any of the buttons to stop the acoustic signal.
- The desired oven function and temperature can be selected before or after the clock functions of cook time  and end time  are set.
- When the cooking time has ended, turn the oven function and temperature dial back to the OFF position.

## Countdown

- Press  button repeatedly, until the countdown indicator  flashes.
- Using the + or – button, set the required countdown (max. 2 hours 30 minutes).
- After approx. 5 seconds, the display shows the remaining time.
- The countdown indicator  will light up.
- When the time has elapsed, the function indicator flashes and an acoustic signal sounds for 2 minutes. Press any button to switch off the signal.



## Cook time

- Press selection button  repeatedly, until the cook time indicator  flashes.
- Using the + or – button, set the required cooking time.
- After approx. 5 seconds, the display returns to the current time. The cook time indicator  will light up.
- When the time has elapsed, the cook time indicator will flash, an acoustic signal will sound for 2 minutes and the oven will switch itself off. Press any button to switch the signal and the programme off.







Please keep this instruction manual for future reference



## End time

- Press selection button  repeatedly, until the end time indicator  flashes.
- Using the + or – button, set the required switch-off time.
- After approx. 5 seconds, the display returns to the current time.
- The end time indicator  will light up.
- When the time has lapsed, the function indicator will flash, an acoustic signal will sound for 2 minutes and the oven will switch itself off. Press any button to switch the signal and the programme off.

## Cook time and end time

- Cook time  and end time  can be used simultaneously, if you want the oven to be automatically switched on and off at a specific time.
- Using the cook time function  set the period of time that the dish requires to cook. For example, 1 hour.
- Using the end time function , set the time at which the dish is to be ready. In this example, 14:05.
- The cook time  and end time  light up and the time is shown in the display. In this example, 12:05.
- The oven will automatically switch itself on at the appropriate time as calculated. In this example, at 13:05 and will switch itself off when the cooking time set has elapsed. In this example, at 14:05.

Please keep this instruction manual for future reference



## CARE AND MAINTENANCE

This appliance is for household use only, don't use it outdoors

### Important:

Unplug your oven before cleaning, or performing maintenance.

To extend the life of your oven, it must be cleaned frequently, keeping in mind that:

- Do not use steam equipment to clean the appliance. To protect against the risk of electrical shock, do not immerse the unit, cord or plug in water. Do not clean the appliance by spraying water onto or into the oven.
- Don't clean the appliance when it is still hot. The inside and external surface of the oven should be cleaned with a damp cloth when it has cooled down.
- Wash all accessories in hot soapy water or in a dishwasher, wipe dry with a paper towel or cloth.
- If you use your oven for an extended period of time, condensation may form. Dry it using a non-abrasive cloth.
- There is a rubber seal surrounding the oven opening which guarantees its perfect functioning. Check the condition of this seal on a regular basis. If necessary, clean it, avoid using abrasive products or objects to do so. Should it become damaged, please contact Caple Service. We recommend you do not use the oven until it has been repaired.
- Never line the oven bottom with aluminium foil, as the consequent accumulation of heat could compromise the cooking and even damage the enamel.
- Clear the glass door using a damp cloth and dry it with a non-abrasive cloth.
- Do not use harsh abrasive cleaners or sharp metal scrapers to clean the oven door glass since they can scratch the surface, which may result in shattering of the glass.

Please keep this instruction manual for future reference



## Replacing the lamp in the oven

- Cut off the supply of power to the oven by turning off the omni-polar switch connecting it to the mains, or by removing the plug if it is accessible.
- Unscrew the glass cover attached to the lamp holder
- Unscrew the lamp and replace it with another high-temperature lamp (300°C) with the following characteristics:

Voltage: AC220V-240V

Wattage: 15W

Socket: E 14

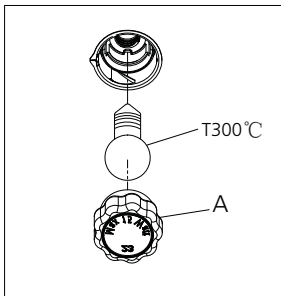

- Remount the glass cover and reconnect the appliance to the power supply.

### **WARNING:**

Ensure the appliance is unplugged before replacing the lamp to avoid the possibility of an electric shock.

Please keep this instruction manual for future reference

Instruction manual C4245 25





## Disassembling the oven door

To make it easier to clean the inside of your oven, the oven door can be removed, by proceeding as follows:

- Open the door completely and lift the 2 levers 'B';
- Now, shut the door slightly, you can lift it out by pulling out the hooks 'A' as shown below.

## Assembling the oven door

- With the door in a vertical position, insert the two hooks 'A' into the slots.
- Ensure that 'D' is hooked perfectly onto the edge of the slot (move the oven door backwards and forward slightly)
- Keep the oven door open fully, unhook the 2 levers 'B' downwards and then shut the door again.

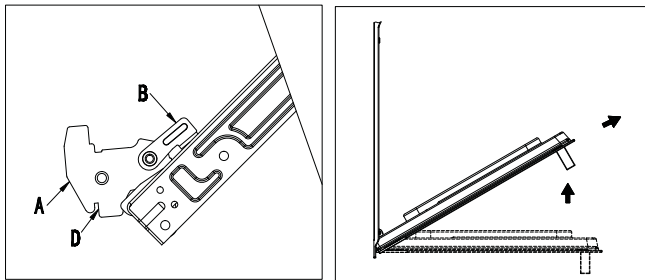

Please keep this instruction manual for future reference





## Removing the glass from the door

The oven door is made up of 3 panes of glass and has vents at the top and bottom. When the oven is operating, air is circulated through the door to keep the outer pane cool. If condensation has worked its way in between the glass panes, the door can be dismantled in order to clean in-between the panes.

- Remove the door as per above instruction and place it on a protective surface (e.g. on a table cloth) to prevent it getting scratched. The door handle should line up with the edge of the table.
- Make sure the glass lies flat to avoid breakage of glass during cleaning.
- Undo the 2 screws on upper bracket.
- Take out upper bracket and first pane of glass.
- Loosen the 4 clips.
- Slide out middle pane of glass carefully.
- Clean the glass panes and other parts with a damp microfibre cloth or a clean sponge and a solution of hot water with a little washing-up liquid. Wipe dry using a soft cloth.

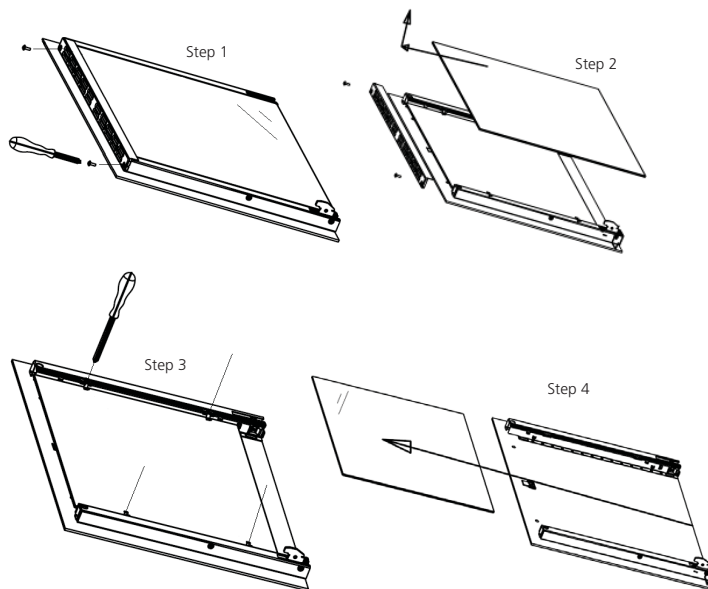

Please keep this instruction manual for future reference





## Fitting oven shelves

- Ensure shelf orientation is correct (see image below)
- Slide into the oven at an angle until raised back of shelf is past the safety stop on the side runners.
- Lower the front of shelf and push in until stop is reached.
- To remove oven shelves, withdraw to the stop and raise the front of shelf to clear the stop.

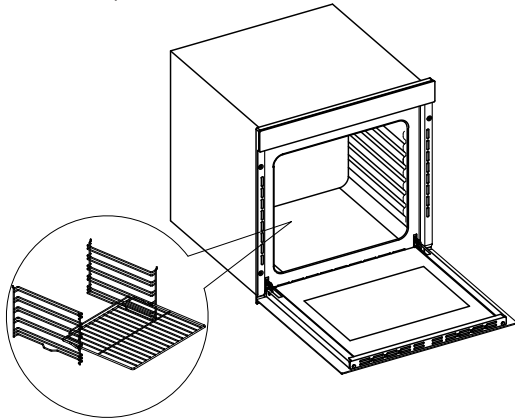

Please keep this instruction manual for future reference





## Telescopic runners (optional accessory)

To assemble the telescopic runners:

- Remove the side racks, lifting them away from the spacers 'A' (see Fig.1)
- Choose which shelf to use with the telescopic runner. Pay attention to the direction in which the runner is to be extracted, position joint 'B' and joint 'C' on the frame (see Fig.2).
- Secure the two side racks with the guide rails using the holes provided on the oven walls (see Fig. 3).The holes for the left rack are situated at hole F1, F2 and the right rack at hole D1, D2.
- Finally, fit the side rack on the spacers 'A'.

### Note:

Telescopic runners are optional accessories and are not included.

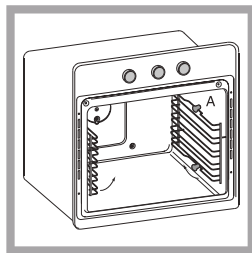

Fig.1

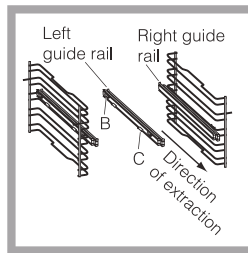

Fig.2

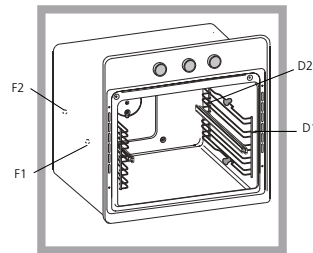

Fig.3

Please keep this instruction manual for future reference



## Troubleshooting

The oven does not operate	Check it is switched on at the mains There has been a power cut The time is not set
The oven does not heat	The thermostat is not turned to a temperature
The interior lamp does not illuminate	Check the product is connected to the electrical supply and is switched on Replace the bulb
Lower and upper parts of the oven are not cooking evenly	Control the shelf location, cooking period and temperatures according to the manual

If you still experience any problems with your appliance please contact Caple Service on 0117 938 7420 or email [service@caple.co.uk](mailto:service@caple.co.uk)

Please keep this instruction manual for future reference





## Technical specification

Model	C4245
Height	720mm
Width	595mm
Depth	546mm
Usable volume	40ltr and 42ltr
Rated Voltage	220-240V

TOP OVEN nominal electrical input in W (toll. +5 / -10%)	
Top outside heating element	750W
Top inside heating element	1000W
Bottom heating element	1050W
Light	15/25W
Maximum electrical input	1820W/230V
MAIN OVEN nominal electrical input in W (toll. +5 / -10%)	
Top outside heating element	1400W
Circle heating element	1600W
Bottom heating element	1050W
Fan	25W
Light	15/25W
Maximum electrical input	2500W/230V

Please keep this instruction manual for future reference



Caple Service  
Fourth Way  
Avonmouth  
Bristol  
BS11 8DW

t: 0117 938 7420  
e: [service@caple.co.uk](mailto:service@caple.co.uk)  
[www.caple.co.uk](http://www.caple.co.uk)

Please keep this instruction manual for future reference

