



Sense Premium,
Single Oven Instruction Manual

C2600, C2600GM, C2600SS, C2600BS



Contact Caple on 0117 938 7420 for spare parts or www.caple.co.uk

CONTENTS

Safety Warnings	4
Environmental Protection	12
Warranty	13
Installation	14
Oven Dimensions	17
Electrical Connection	18
Control Panel and Display	20
Operation	21
Settings Menu	42
Oven Functions	47
Special Functions	50
Pyrolytic Cleaning	58
Using The Rotisserie	61
Using The Meat Probe	63
Care and Maintenance	65
Removing the Glass Panels	68
CapleHome App	70
Troubleshooting	77
Error Codes	79
Caple Contact Details	80

Welcome to your new Sense Premium Oven.
Featuring our new CapleTouch+ Technology, you'll be able to save your family favourites, set multi-stage cooking timers and customise your oven display with ease.

To control your appliance from your smart phone or tablet, download the CapleHome App  from www.caple.co.uk

SAFETY INSTRUCTIONS:

Read these instructions carefully and completely before using your appliance. They provide you with important information regarding the safe installation, use and maintenance of the appliance as well as useful advice for getting the best out of your oven. Keep this booklet in a safe place for future reference and pass on to any future owner.

INSTALLATION WARNINGS:

- This appliance is produced in accordance with all applicable local and international standards and regulations.
- This appliance is designed only for cooking food and is intended for indoor use.
- This appliance is intended to be used in household and similar applications such as:
 - › Staff kitchen areas in shops, offices and other working environments.
 - › Farm Houses.
 - › By clients in hotels, motels and other residential type environments.
 - › Bed and breakfast type environments.
- Do not try to lift or move the appliance by pulling the door handle.

- This oven may only be used by persons (including children) with reduced physical, sensory or mental capabilities, or lack of experience and knowledge, if they are supervised whilst using it. They may only use it unsupervised if they have been shown how to use it in a safe manner. They must be able to recognise and understand the dangers of misuse.

SAFETY WITH CHILDREN:

- This appliance can be used by children aged from 8 years and above.
- Children less than 8 years of age should be kept away unless continuously supervised or they have been shown how to use it in a safe manner. Children must be able to understand and recognise the possible dangers caused by incorrect operation.
- Children should be supervised in the vicinity of the oven. Never allow children to play with the oven.
- Cleaning and user maintenance should not be carried out by children without supervision.
- External parts of the oven such as the door glass, control panel and the vent become hot. Do not let children touch the oven when it is in operation.
- The oven gets much hotter during pyrolytic cleaning than during normal use. Do not let children touch the oven during pyrolytic cleaning.
- Materials used for packaging (nylon, staplers, Styrofoam etc) may cause harmful effects to children, they should be disposed of immediately.

- Children can injure themselves on an open door. Do not let children sit on the open door, lean against it or swing on it.

TECHNICAL SAFETY:

- Maintenance and repair work must be made only by authorised Caple service technicians. Installation and repair work that is carried out by unauthorised technicians may endanger you.
- While the oven is under warranty, repairs should only be undertaken by a Caple authorised service technician. Otherwise the warranty will be invalidated.
- It is dangerous to alter or modify the specifications of the appliance in any way. The requirements for this appliance are stated on the rating label.
- Risk of injury due to electric shock. Any contact with live connections or tampering with the electrical or mechanical components of the oven will endanger your safety and may lead to the oven malfunctioning. Do not open the oven housing under any circumstances.
- To maintain the efficiency and safety of your appliance, we recommend you always use original spare parts and to call only our authorised Caple Service agents in case of need.
- Multi-socket adapters and extension leads should not be used to connect the oven to the mains electricity supply.

- The electrical system of this appliance may be used safely only when it is correctly connected to an efficient earthing system in compliance with the safety standards currently in effect.

INSTALLATION WARNINGS:

- Prior to installation, ensure that the local distribution conditions (electricity voltage and frequency) and the requirements of the appliance are compatible.
- During installation the oven must be completely disconnected from the mains electricity supply.
- Do not operate the appliance before it is fully installed.
- The appliance must be installed by an authorised technician.
- Caple is not responsible for any damage that may be caused by defective placement and installation by unauthorised persons.
- When unpacking the appliance, make sure that it is not damaged during transportation.
- Check the oven for any damage, such as misaligned or bent door, damaged door seals and sealing surface, broken or loose door hinges and latches and dents inside the cavity or on the door.
- In the case of any defect; do not use the appliance and contact your retailer or Caple Service immediately.
- Ensure that the supply cord is not wedged during the installation. If the supply cord is damaged, it must be replaced by a Caple service technician or similarly qualified persons in order to prevent a hazard.

- Protect your appliance against atmospheric effects. Do not expose it to effects such as sun, rain, snow etc.
- The surrounding materials of the appliance (i.e. kitchen cabinet or furniture) must be able to withstand a minimum temperature of 120°C.

DURING USE:

- Before using the oven for the first time, heat the empty oven at max. temperature for 1 hour on Fan Heat – removing any unpleasant smells and smoke caused by working residues and thermal insulation. Make sure you do this in a well-ventilated area.
- Before use, remove all plastic films protecting some parts of the appliance (fascia - panel, parts in stainless steel, etc.).
- While opening the oven door, step back to avoid the hot steam coming out of the oven as there may be a risk of burns.
- Do not put flammable or combustible materials in or near the appliance when it is operating.
- During use, handles can get hot.
- The appliance and its accessible parts become hot during use. Care should be taken to avoid touching heating elements.
- Always use oven gloves to remove and replace food in the oven, or to adjust oven shelves if the oven compartment is hot.
- Liquids and other foods must not be heated in sealed containers since they are liable to explode.

- Only use plastic containers that are suitable for use in an oven.
- Pay close attention to the oven while cooking with solid or liquid oils as they could potentially catch fire when oven is hot.
- Never pour water on flames that are caused by oil. Cover the saucepan or frying pan with its lid in order to choke the flame and turn the oven off.
- Never roast or bake on the oven base.
- If you know you will not be using the appliance for a while, switch it off and isolate it from the electrical supply.
- The oven shelves and trays incline when pulled out. Be careful not to let hot liquid spill over.
- When the door of the oven is open, do not leave anything on it. It may unbalance your appliance or damage the door.
- Make sure that nothing gets trapped between the door and the oven compartment.
- Do not put anything heavy, flammable or ignitable (nylon, plastic bag, paper or cloth etc) into the oven. This includes cookware with plastic accessories (e.g. handles).
- Do not hang towels, dishcloths or clothes from the appliance or its handles.
- To avoid fire hazards, do not use the oven for storage purposes.

- Do not touch the appliance with wet hands.
- Do not obstruct the ventilation openings.
- Do not allow supply cords from other small appliances to come into contact with the oven.
- Do not use the appliance to heat a room.
- Do not place magnets on the oven door. Magnets can scratch the surface as well as damage your oven.
- The oven compartment floor can become damaged by items being pushed around. Ensure pots, pans and crockery are carefully placed in the oven.
- If smoke is observed. Switch off or unplug the appliance and keep the door closed in order to stifle any flames.
- When the appliance is not in use, we recommend you turn it off, and isolate it from the electrical supply.
- The appliance is not intended to be operated by means of an external timer or separate remote-control system.
- The manufacturer will not be held liable for any damages that might arise out of incorrect or improper use of the appliance.

CLEANING AND MAINTENANCE:

- Always switch off the appliance from the mains isolating the electrical supply before any cleaning or maintenance.
- The oven should be cleaned regularly and any food deposits removed.
- All possible security measures have been taken to

ensure your safety. Since the glass may break, you should be careful while cleaning to avoid scratching.

- Do not use harsh abrasive cleaners or sharp metal scrapers to clean the oven door glass or any other surface of the appliance as it can scratch the surface which may result in the glass shattering or permanent damage to the surface.
- Do not use steam cleaners for cleaning the appliance.
- Ensure the appliance is switched off before replacing the lamp to avoid the possibility of electric shock.
- Failure to maintain the oven in a clean condition could lead to deterioration of the surface that could adversely affect the life of the appliance and possibly result in a hazardous situation.

ACCESSORIES:

- Avoid hitting or knocking the glass with accessories.
- Before operating the Pyrolytic function, ensure all internal shelves, trays and side racks are removed. Accessories that are not suitable for this function will be damaged by the high temperatures.
- Only use the Caple meat probe supplied with the appliance. If it is faulty, it must be replaced with a new original Caple meat probe.
- Do not store the meat probe in the oven compartment when it is not being used.



ENVIRONMENTAL PROTECTION

Waste electrical products should not be disposed of with household waste. Please recycle where facilities exist. Check with your Local Authority or retailer for recycling advice. This appliance is marked according to the European directive on Waste Electrical and Electronic Equipment (WEEE).

By ensuring this product is disposed of correctly, you will help prevent potential negative consequences for the environment and human health, which could otherwise be caused by inappropriate waste handling of this product. The symbol on the product indicates that this product may not be treated as household waste. Instead it shall be handed over to the applicable collection point for the recycling of electrical and electronic equipment. Disposal must be carried out in accordance with local environmental regulations for waste disposal.

For more detailed information about treatment, recovery and recycling of this product, please contact your local council, your household waste disposal service or the retailer where you purchased the product.

CE DECLARATIONS OF CONFORMITY

Radio Equipment Directive (RED) 2014/53/EU

This Declaration is issued under the sole responsibility of the manufacturer.

Hereby, Caple declares that the radio equipment included in the product is in compliance with the RED directive 2014/53/EU.

The full text of the EU Declaration of Conformity is available on our website www.caple.co.uk.

UKCA DECLARATIONS OF CONFORMITY

This appliance has been manufactured to the strictest standards and complies with all applicable legislation.

TECHNICAL	
Rated Voltage	220-240V
Rated frequency	50/60Hz
Power	2900 - 3570W
WiFi Band	2.4Ghz

TECHNICAL FICHE

This appliance conforms to all current and applicable energy regulations. To view the Technical Fiche that supports the energy labelling data, please visit the product page on our website www.caple.co.uk

WARRANTY:

Your new appliance is covered by warranty. The warranty card is enclosed - if it is missing, you must provide the following information to your retailer in order to receive a replacement: date of purchase, model and serial number (found inside the door opening). Registration can also be completed online by visiting www.caple.co.uk.

Ensure you keep your warranty card safe, you may need to show it to Caple Service together with proof of purchase.

If you fail to show your warranty card you will incur all repair charges.

Spare parts are only available from Caple Service and spare parts authorised centres.

INSTALLATION

IMPORTANT:

Isolate your oven from the electrical supply before performing installation or maintenance.

- › Installation should be carried out according to the instructions by a professionally qualified person only.
- › The manufacturer declines all responsibility for any damage to persons, animals or materials due to incorrect installation.

FITTING THE APPLIANCE

Fit the appliance into its surround (beneath a worktop or in an appliance tall housing) by inserting screws and plastic covers into the 2 holes (A – fig.1) that can be seen in the frame of the oven when the door is open. The screws should then be fixed into the kitchen carcass.

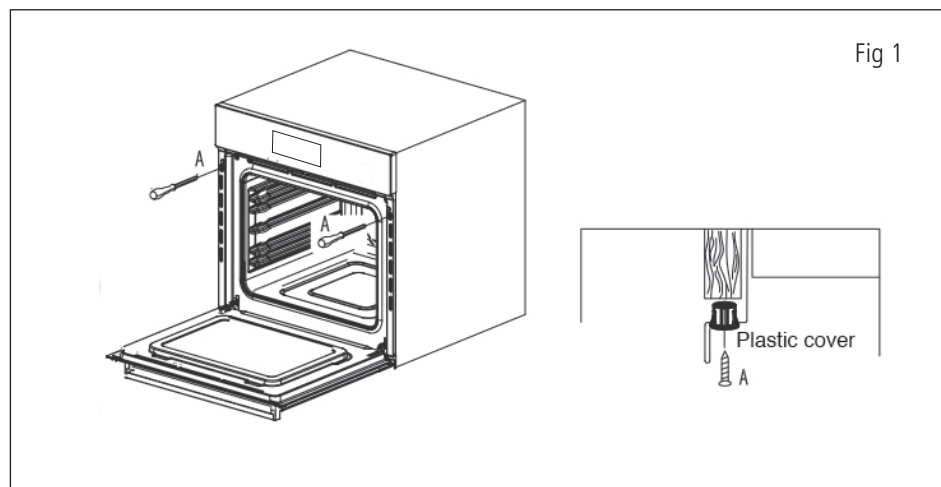

For the most efficient air circulation, the oven should be fitted according to the dimensions shown below:

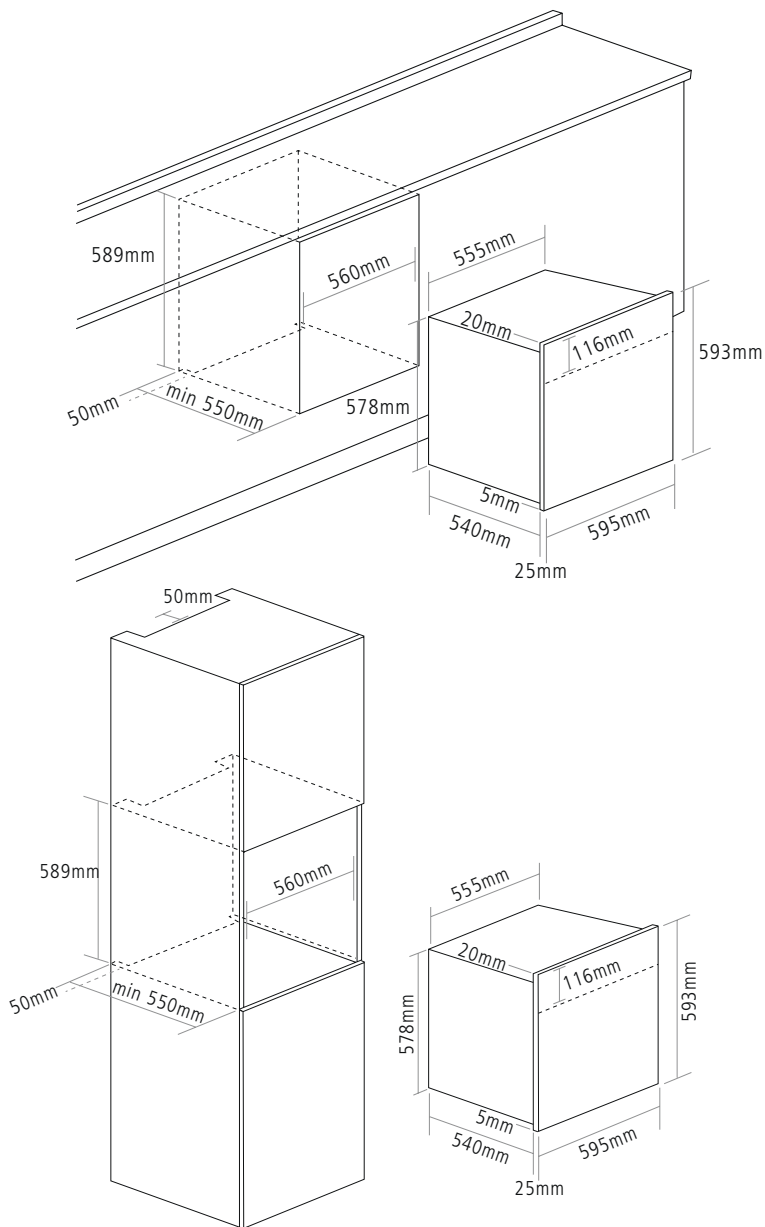

The rear panel of the cabinet must be removed so that air can circulate freely. The panel to which the oven is fitted should have a gap of at least 50mm at the rear for ventilation:

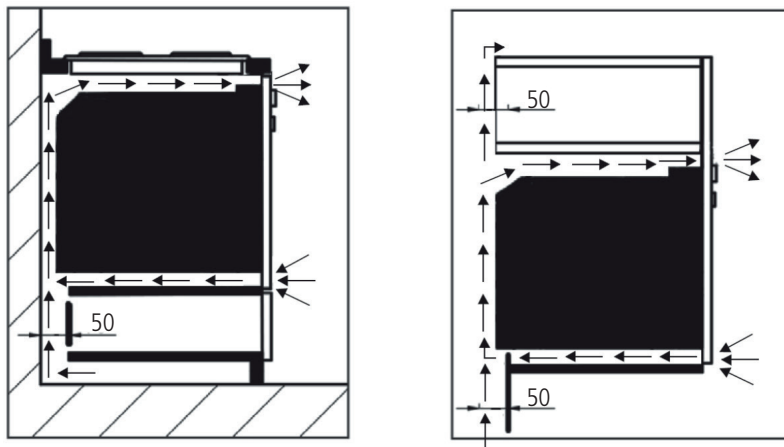

See page 17 for full dimensional drawings of your oven to help with installation.

For a built-in oven to work well, the cabinet must be of the right type.

The panels of the adjoining furniture should be heat resistant. Particularly when the adjoining furniture is made of veneered wood, the adhesives should be able to withstand a temperature of 120°C. Plastic materials or adhesive which cannot withstand this temperature may become deformed or unstuck.

To comply with safety regulations, once the appliance has been fitted it should not be possible to make contact with the electrical parts.

All parts which offer protection should be fixed in such a way that they cannot be removed with the use of a tool.

OVEN DIMENSIONS

FRONT

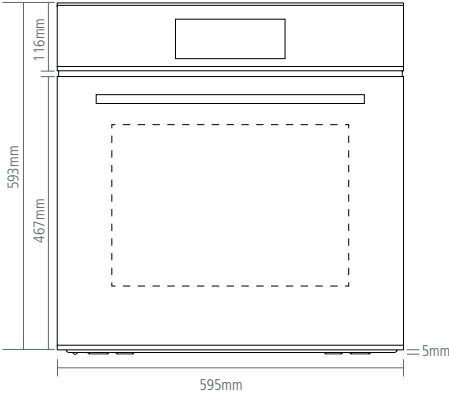

TOP

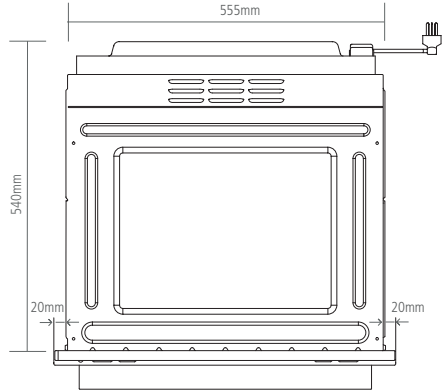

SIDE

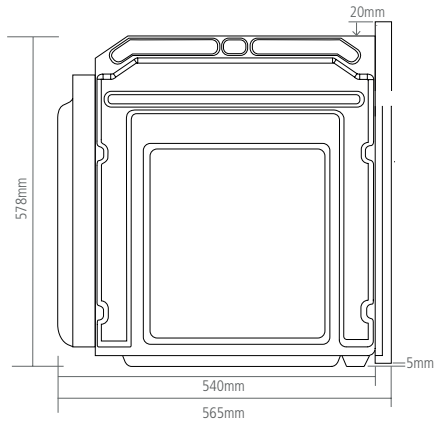

ELECTRICAL CONNECTION

WARNING:

This appliance must be earthed.

Check that the power rating of the mains supply is suitable for the maximum power of the appliance as indicated on the rating label. The fuse rating for this appliance is 16amp. The appliance is supplied with a mains lead it should be "Hard wired" as follows:

- › The "yellow/green" earth wire, which must be connected to a terminal, and has to be about 10mm longer than the other wire.
- › The neutral wire has to be connected to the terminal marked with a letter N.
- › The Live wire should only be connected to the terminal marked L.

Mains connection can also be made by fitting a double pole switch with a minimum gap between the contacts of 3mm, proportionate to the load and complying with the regulations in force.

WARNING:

The yellow/green earth wire should not be controlled by the switch.

When a double pole switch is used for mains supply connection it should be easily accessed, once the appliance is in position.

IMPORTANT:

The mains supply cable should be positioned so that it is never subjected to temperatures which are more than 50°C above ambient temperature.

The electrical safety of the appliance can only be guaranteed when it has been correctly connected to a properly earthed mains electrical supply, as laid down in the current regulations for electrical safety.

The manufacturer cannot be held responsible for any damage to persons or objects due to lack of an earth connection.

The ovens are designed to operate with a mono-phase alternating current of 220-240V, 50Hz.

BEFORE THE INSTALLATION OF THE APPLIANCE, CHECK THE SPECIFICATIONS ON THE RATING LABEL.

CONTROL PANEL AND DISPLAY

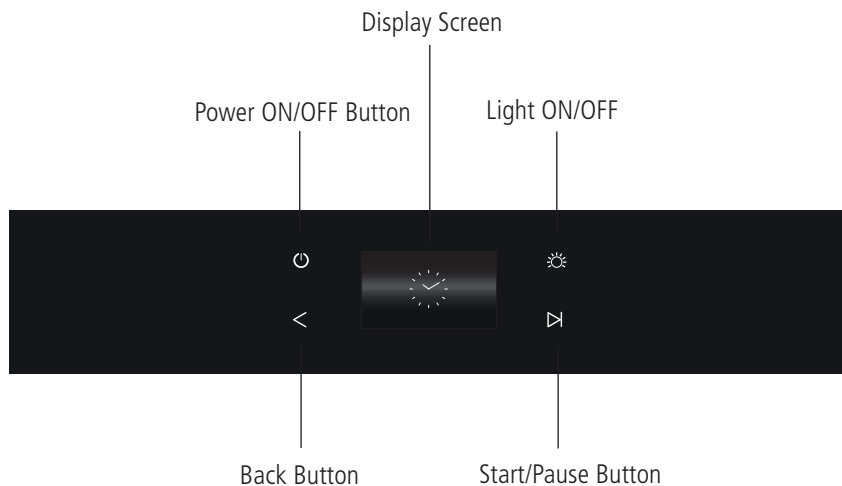

ACCESSORIES

- 1 X Rotisserie
- 1 X Meat Probe
- 2 X Full Extension Telescopic Runners
- 2 X Safety Stop Shelves
- 1 X Enamel Grill Rack
- 1 X Enamel Grill Pan with Handle

To purchase additional or replacement accessories, please visit www.cagle.co.uk

OPERATION

POWER BUTTON:

To turn the display screen On and Off.

NOTE:

Turning Off will take you to the standby screen.

LIGHT BUTTON:

Press the light button on the control panel to switch the internal oven lights on and off.

Press and hold for 3 seconds to activate/deactivate Child Safety Lock.

NOTE:

The light will turn itself off after 10 minutes of inactivity.

BACK BUTTON:

Press to return to the previous screen on the display.

Press to cancel cooking.

START/PAUSE BUTTON:

After turning the oven on, select your desired cooking programme and duration and press  to start cooking.

Press  while the oven is in operation to pause cooking.

NOTE:

Pause feature only available during Single Stage Cooking, multi-stage cooking cannot be paused.

NAVIGATING THE TOUCH CONTROL DISPLAY:

To adjust Times, Dates, Temperatures and Functions etc., press the up and down arrow controls or scroll by pressing and dragging up and down.

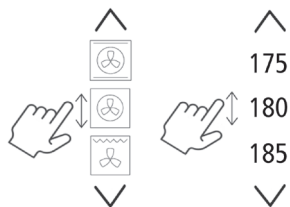

TIP: When adjusting temperatures and times, press and hold \wedge or \vee to scroll quickly.

USING FOR THE FIRST TIME

1. Press  to turn the appliance on.

When turning the appliance on for the first time you will be asked to set the date and time.

NOTE:

All other menu items cannot be selected at this point.

2. Adjust the Time before pressing



3. Adjust the Date before pressing

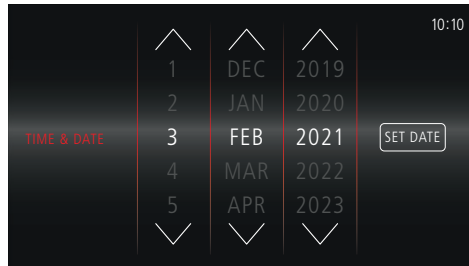

4. Select whether you want the Time and Date to display on the Standby Screen.

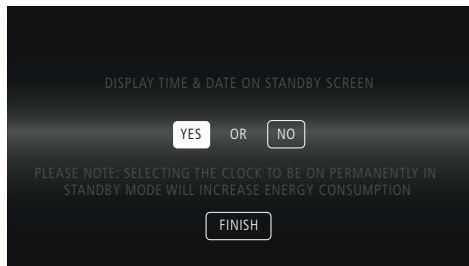

PLEASE NOTE:

Selecting to have the clock on permanently in standby mode will increase Energy consumption. If **Yes** is selected, the default clock display will be analogue mode. This can be changed later in the **Settings Menu**.

5. To complete setup, press

QUICKSTART GUIDE

To quickly start cooking without setting a timer and cooking stage or saving to favourites, proceed as follows:

1. Press  to turn the appliance on. The home screen will appear.

The oven is automatically set to Fan Heat Function at 180°C. To start cooking press .



2. The timer will count up from 00:00.

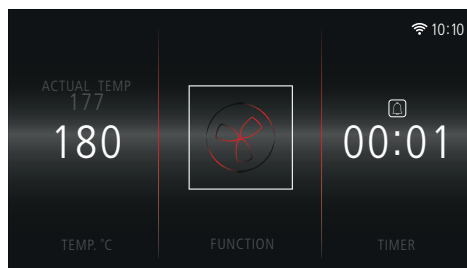

NOTE:

If you press the timer to set a Cooking Duration, the timer will count down from the new set time.

SETTING COOKING STAGES AND SAVING TO FAVOURITES

ONE COOKING STAGE:

1. Press  to turn the appliance on.
2. Select desired Function, Temperature, Boost (if required).

Then press 

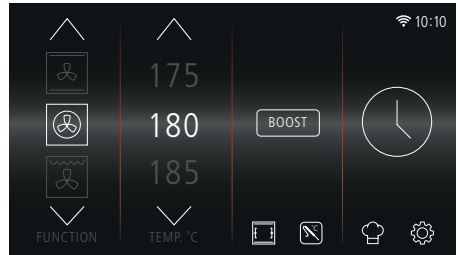

3. Select a Cooking Duration and End Time.

NOTE:

Cooking duration is shown in hours and minutes 'hr:mins'.

End Time will automatically adjust once Duration is set.

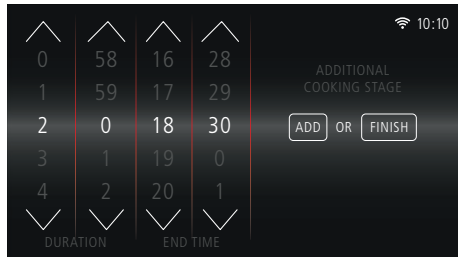

If only one cooking stage required press

4. Review selection, press to change selection. Press  to begin cooking without saving or press to store in your favourite's menu.

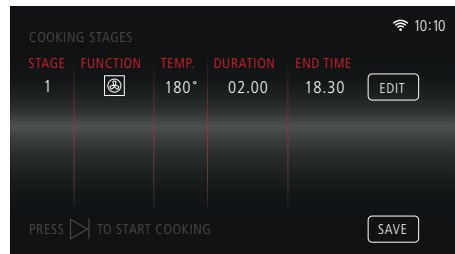

5. If saving to favourites, name your selection and press . If required, press to amend your selection name, or press to store in your favourites.

NOTE:

Selection names are limited to 14 characters.

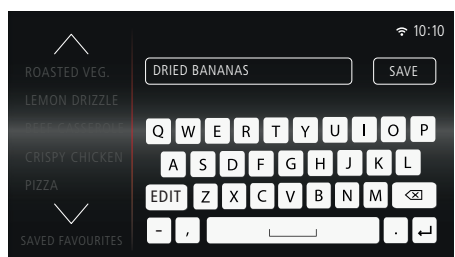

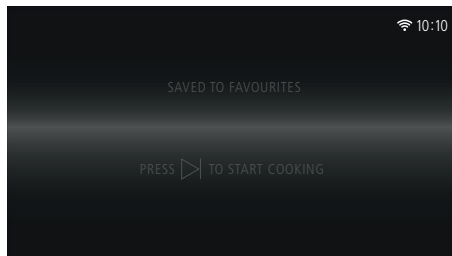

6. Press  to begin cooking.

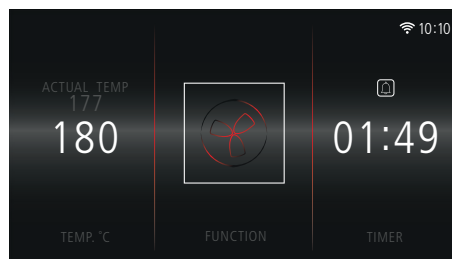

7. Cooking will begin and the main cooking screen will display.



8. When cooking has completed. **'COOKING FINISHED'** will appear.

If a timer has been set, turn off the end of cooking alarm by pressing either  or  button.

Pressing the  button will cancel the alarm and turn the light on.

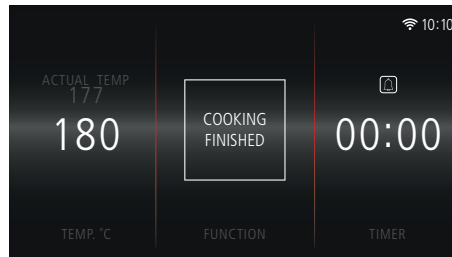

MULTI-STAGE COOKING

1. Press  to turn the appliance on.
2. Select desired Function, Temperature, Boost (if required).

Then press 

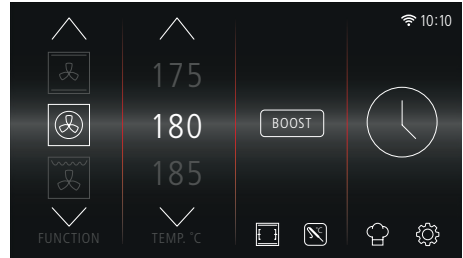

3. Select a Cooking Duration.

To add additional cooking stages press 

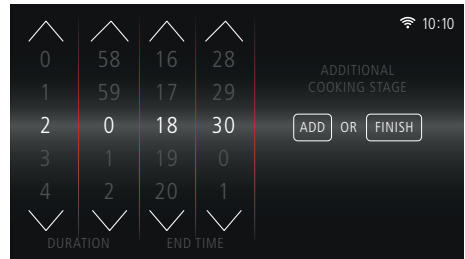

4. Select desired Function, Temperature, Boost (if required).

Then press 



NOTE:

If  is pressed before a 2nd stage timer has been selected, '**PLEASE SELECT COOKING TIME**' message will appear.

Select a cooking Duration and/or End Time to continue.

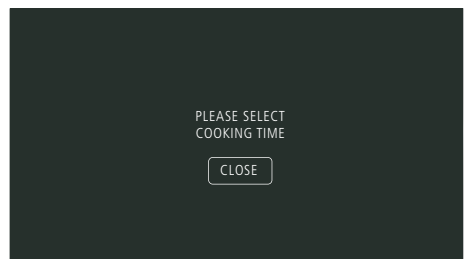

5. Select 2nd cooking stage Duration.

Further Cooking Stages (maximum of 4 in total) can be added by repeating the **ADD** process.

Press **FINISH** to go to overview screen.

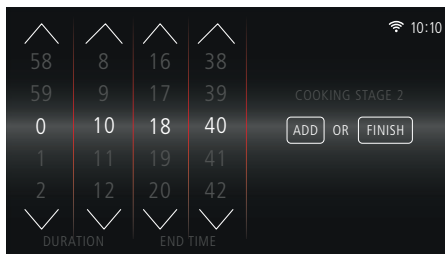

6. Review selection, press **EDIT** to change selection.

Press **▶** to begin cooking without saving or press **SAVE** to store in the favourite's menu.

NOTE: If you press **EDIT** on multi-stage cooking, the timer will reset. Press  to reset time before proceeding.

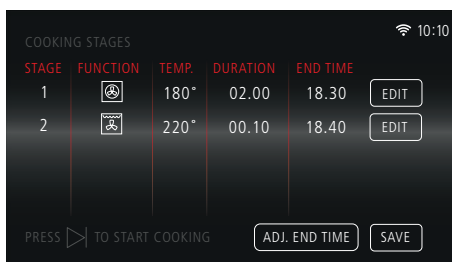

7. Name your selection, press **↩** and then press **SAVE** to store to favourites.

NOTE:

Selection names are limited to 14 characters.

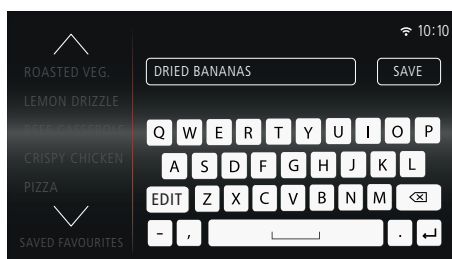

8. Press **▶** to begin cooking.

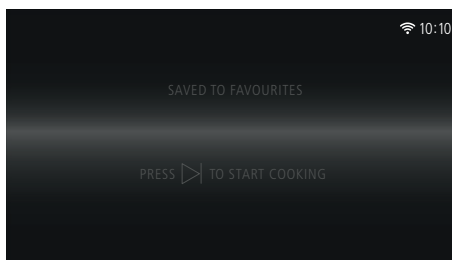

9. Cooking will begin and the main cooking screen will display.

EDITING STAGES BEFORE COOKING

1. To Edit a cooking stage before cooking has begun, press **EDIT** next to the relevant stage on the Cooking Review screen.

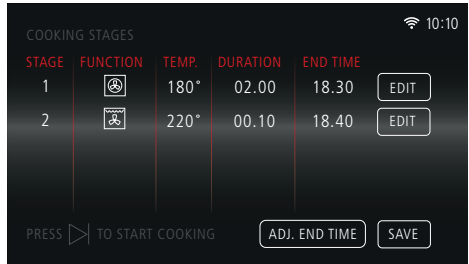

2. The Cooking Selection Screen will appear for the chosen cooking stage. Make the necessary amends and then press to continue.



NOTE:

When multi-stage cooking, pressing **EDIT** will reset the timer for that cooking stage.

If is pressed before a timer has been selected, **'PLEASE SELECT COOKING TIME'** message will appear.

Press , select a cooking duration and/or End Time to continue.

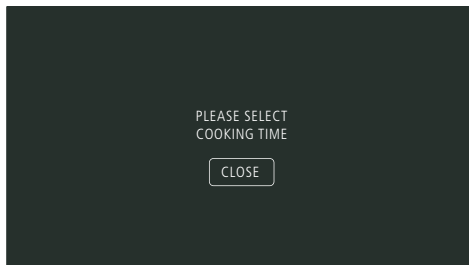

If you no longer want to Edit the selected cooking stage press the < button.

'WOULD YOU LIKE TO CONTINUE EDITING OR REVIEW COOKING'

message will appear.

Press **REVIEW** to return to the cooking review screen.

Press **EDIT** to continue editing.

NOTE:

Please refer to bottom of page 38 for more information on Adjusting the End Time before cooking.

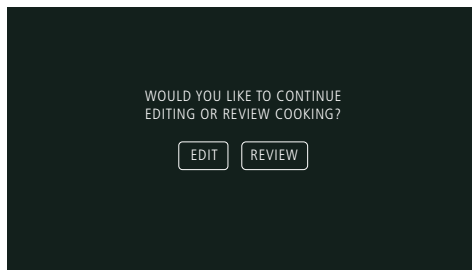

CANCELLING STAGES BEFORE COOKING

To Cancel your cooking stage(s) before cooking has begun, press the < button when in the Cooking Review screen.

The Homescreen will appear and any previous cooking stage(s) will have been cancelled.

NOTE:

During multi-stage cooking, all cooking stages will be cancelled.

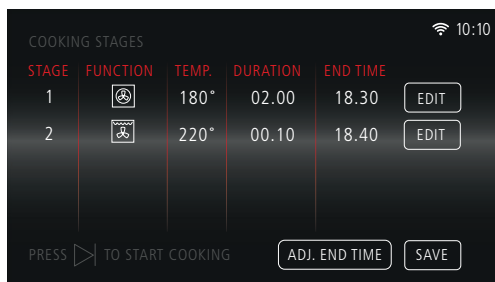

AUTOMATIC COOKING

After selecting a Cooking Duration, you can adjust the End Time so that your cooking automatically starts later in the day.

Oven Start Time = End Time – Duration

For example: If you select a Duration of 2 hours and an End Time of 6:30pm, your cooking Start Time will be 4:30pm.

After selecting desired cooking Duration and End Time, press  to begin cooking. The standby screen will appear with **'COOKING WILL START AT...'** message.

At the Start Time, the oven will automatically turn on and begin cooking.

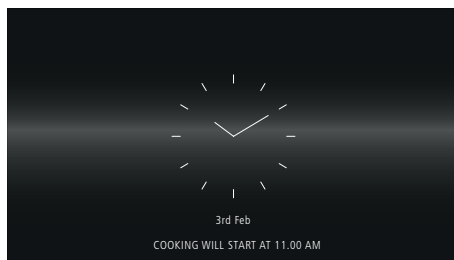
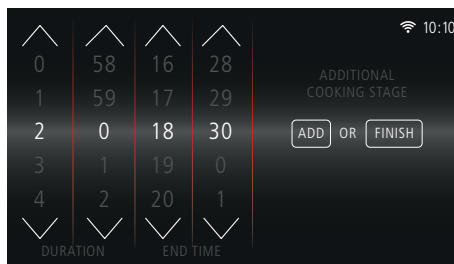

NOTE:

To set automatic cooking for multi-stage cooking, do not adjust the end times in the timer section. Use the **ADJ. END TIME** button in the review screen, as this will edit the end time of all cooking stages.

END TIME ERROR

If an End Time is selected that is sooner than the **'Current Time + Duration Time'**, an Error message will display.

For example: If the current time is 10:10am, you select a Duration of 2 hours and an End Time 12:00pm, the Error message will appear.

I.E. $10:10 + 02:00 = 12:10$

Adjust the end time accordingly, so **'IT IS EQUAL TO OR GREATER THAN THE CURRENT TIME + DURATION TIME'** to proceed.

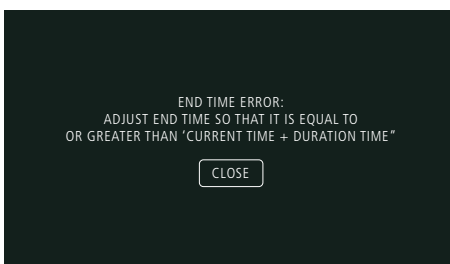
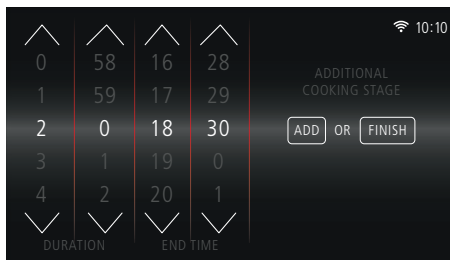

AUTO-TIME

If no Timer is set, when you press  to begin cooking, the Timer will count up from 00:00, so you can see how long you have been cooking.

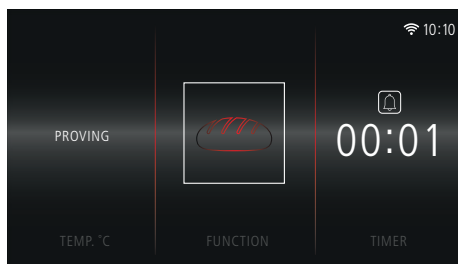

ADJUSTING COOKING TEMPERATURE AND TIMER DURING COOKING

It is simple to make adjustments to the Cooking Temperature and Timer from the main cooking screen.

ADJUST TEMPERATURE

Touch the Temperature ('180') to adjust. The left column appears as shown to allow adjustment.

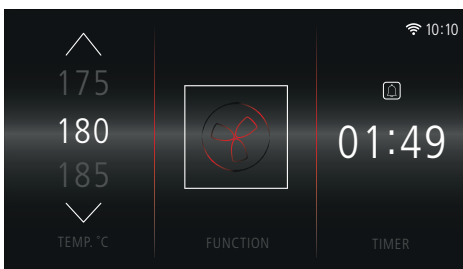

Once the new temperature is selected, wait 3 seconds for it to confirm. Once confirmed it will return to the normal cooking screen and display the new temperature.

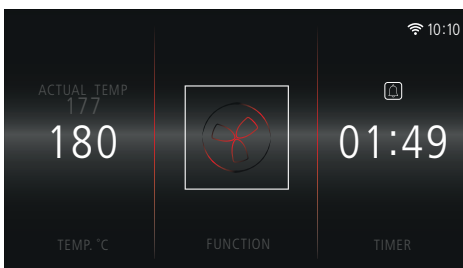

ADJUST TIMER

Touch the Timer Display ('01:49') to amend cooking time.

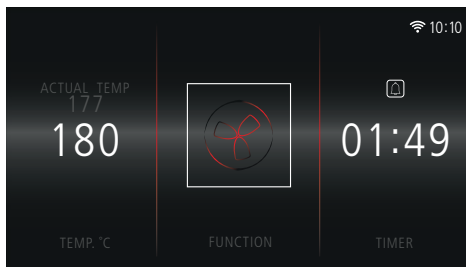

The Time Adjustment screen will appear.

Use controls to adjust the Duration and End Time, then press **FINISH** to return to Main Cooking Screen.

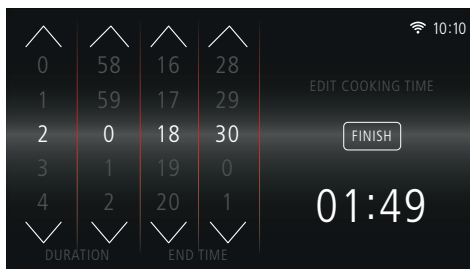

SETTING THE MINUTE MINDER

Pressing  on the main cooking screen takes you to the Minute Minder screen. Here you can set an alarm separate to the timer, to sound after a pre-set duration.

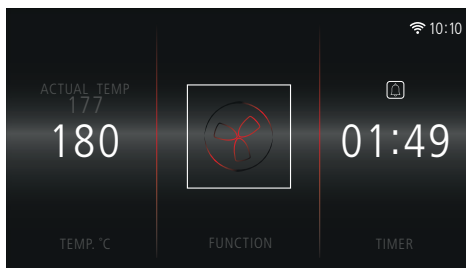

Use the controls to set the Minute Minder for your desired duration, then press **SELECT**.

If no adjustments are made, the main cooking screen will display after 3 seconds.

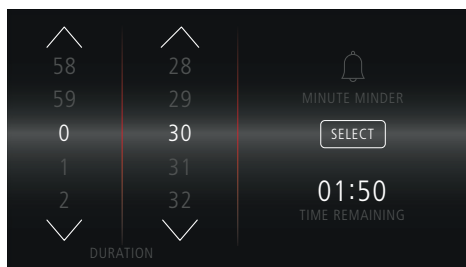

The Minute Minder Symbol will now appear white. Press the Minute Minder symbol again to view the time remaining before the audible alarm sounds.

NOTE:

To cancel the Minute Minder, press , reduce the Duration to 00:00, then press **SELECT**.

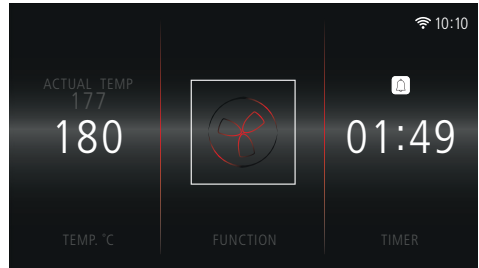

When the alarm sounds, the Minute Minder symbol will flash. To turn the alarm off, press .

RESIDUAL HEAT

When cooking has completed, the oven's **RESIDUAL HEAT** will display on the Standby screen.

If you decide to make a new cooking selection and the Residual Temperature is greater than the Set Temperature, **'WARNING! Residual temperature is higher than set temperature'** message will appear.

Press to remove the warning and proceed with cooking. You will still be able to proceed with your chosen temperature, this is just to warn you that the high residual temperature may effect your cooking results.

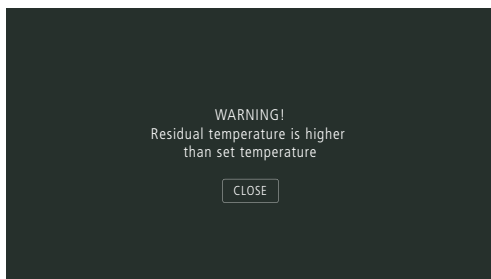

CHILD SAFETY LOCK



To activate the Child Safety Lock, press and hold the  button for 3 seconds.

COOKING: When the Child Safety Lock is turned ON during cooking, both the touch screen display and control panel (ON/OFF, LIGHT, BACK, START/PAUSE buttons) will be disabled.

NOT COOKING: When the Child Safety Lock is turned ON when you are not cooking, only the control panel (ON/OFF, LIGHT, BACK, START/PAUSE buttons) will be disabled.

When the lock is activated the symbol  will appear in the top left corner of the display screen.

To deactivate, press and hold the  button for 3 seconds.

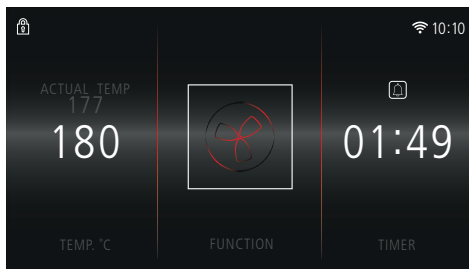

BOOST

If Boost is available, you can select this option to heat up the oven faster.

When activated, the  symbol will appear above the function symbol on the cooking overview screen.

Boost will stop when the oven reaches the required temperature.

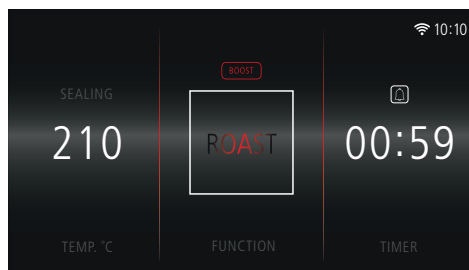

NOTE:

Only available on certain functions (see 'OVEN FUNCTIONS').

FAVOURITES



- › To view your saved favourites, press  on the Function Selection Screen.

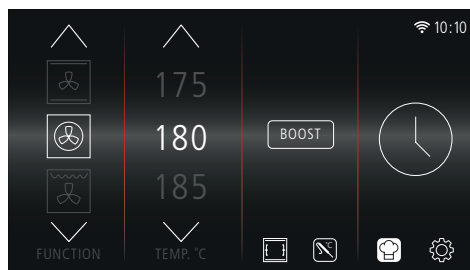

- › Choose from your favourites:
Press **SELECT** to view relevant cooking stages, edit stages if necessary and begin cooking.
Press **DELETE** to remove a saved favourite.



- › To confirm deletion, press **YES**
- › To cancel and return to previous screen, press **NO**

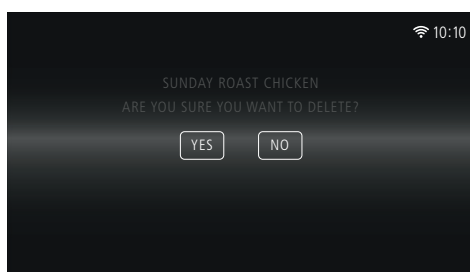

- › When a favourite cooking programme has been selected, the end time will reset based on the current time.
- › To start cooking later in the day press **ADJ. END TIME**

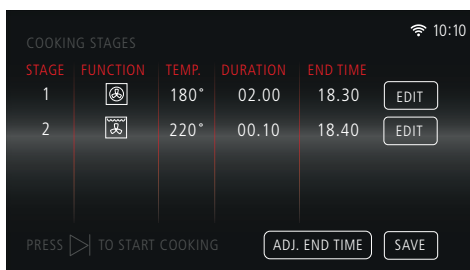

- › Adjust the End Time and press

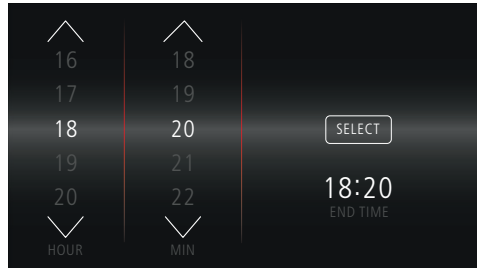

- › The Cooking Review Screen will now show the new End Time.
- › Edit or Save cooking selection if necessary, then press to begin cooking.

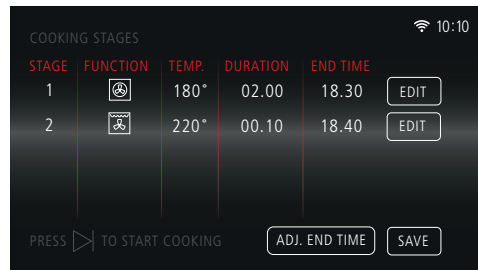

NOTE:

If an End Time is selected that is sooner than the '**Current Time + Duration Time**', the **END TIME ERROR** message will display.

Adjust the end time accordingly, so '**IT IS EQUAL TO OR GREATER THAN THE CURRENT TIME + DURATION TIME**' to proceed.

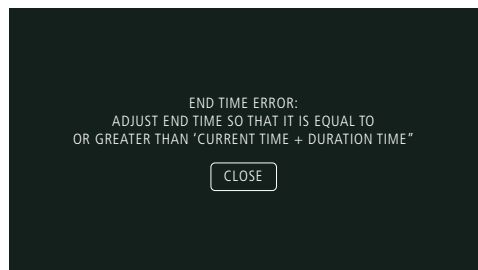

REVIEW AND CANCEL COOKING

To review and/or cancel your selection after cooking has begun, press the **<** button.

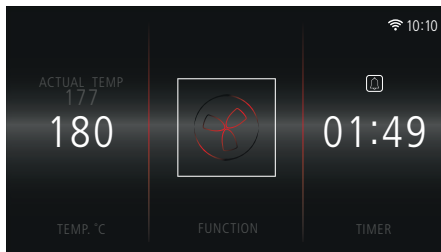

- › From here, proceed to select either **YES** **NO** or **REVIEW**

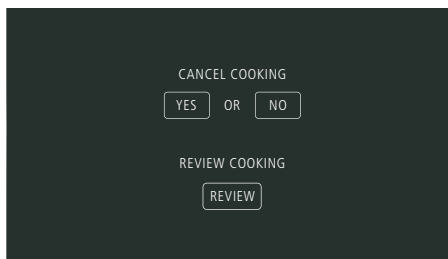

- › Selecting **REVIEW** will display the cooking stages screen. Press **CONTINUE** to resume cooking.

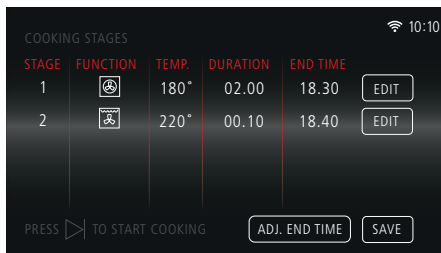

- › Selecting **YES** will end cooking and display the home screen.
- › Selecting **NO** will return to the main cooking screen.

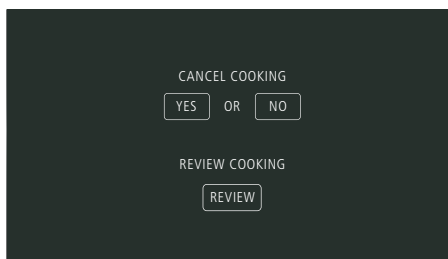

PAUSE COOKING

To pause cooking press the  button.

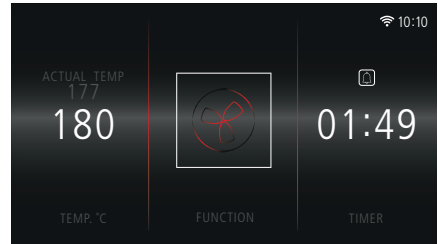

'**COOKING PAUSED...**' message will display.

Press  to continue cooking.

NOTE:

Pause will only work when one cooking stage has been set.





If the  button is selected during Multi-Stage Cooking,

'**PAUSE FUNCTION NOT AVAILABLE...**' message will display.

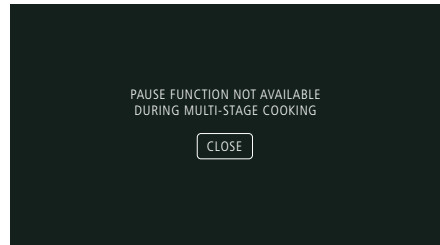
Press  to return to the main cooking screen.



NOTE:

When cooking is paused, the  will not work. If you would like to cancel cooking, press  to resume cooking, and then press the  button to cancel cooking.

SETTINGS MENU

The settings menu is accessed by pressing the  symbol on the home screen.

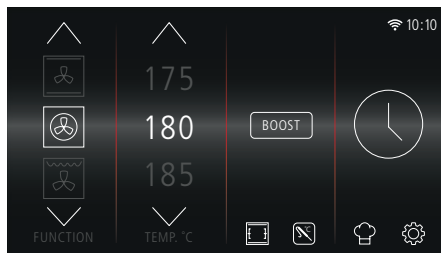

From here you will be able to customise the following options for your oven:



TIME AND DATE

Adjust the Time using the controls before pressing **SET TIME**

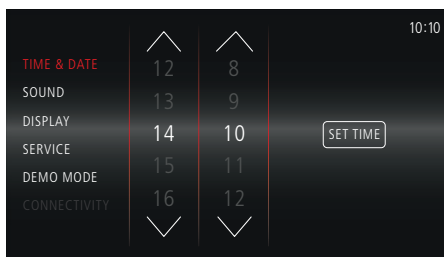

Press **SELECT** underneath Analogue or Digital.

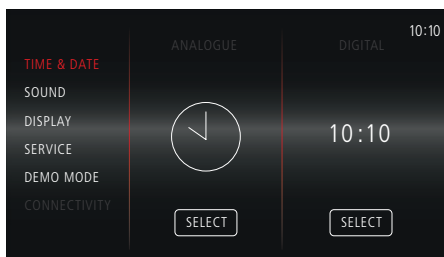

If Digital is selected, choose either a 24- or 12-hour clock, by pressing **SELECT** underneath your desired option.

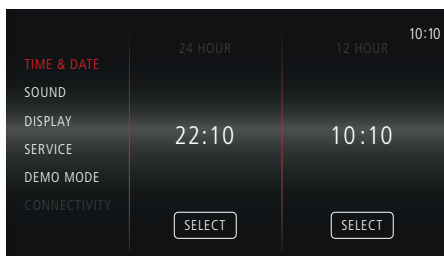

Adjust Date using the controls before pressing **FINISH** to return to the Settings Menu.

Press the **<** button to return to the home screen.

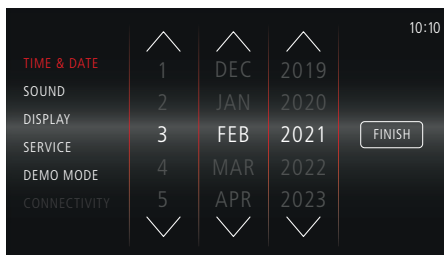

SOUND

Set Key Tone, Key Volume and Alarm Volume levels.

After making your adjustments, select a different setting option from the menu or press the < button to return to the home screen.

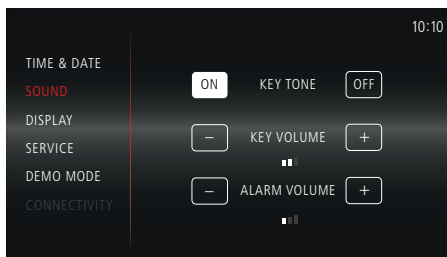

DISPLAY

Choose whether to display Date and Time as well as adjust the screen brightness.

If **ON** is selected for '**Display Date**' or '**Display Time**', the Night Mode option becomes available.

If **OFF** is selected, then this option will be unavailable.

Night mode is an Energy Saving option where between the hours of 11pm and 6am, the brightness of the display is reduced to the minimum.

After making your adjustments, select a different setting option from the menu or press the < button to return to the home screen.

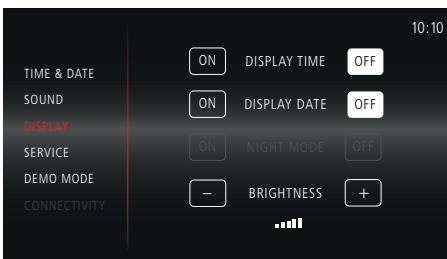
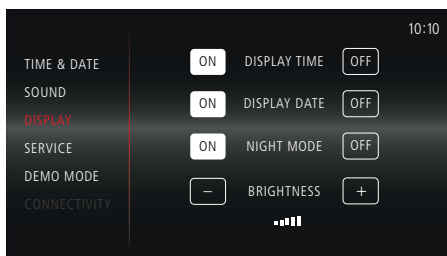

SERVICE

View Error codes and reset the appliance.

After making your adjustments, select a different setting option from the menu or press the < button to return to the home screen.

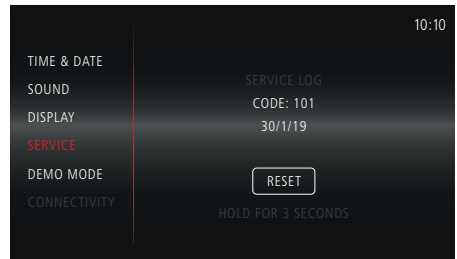

DEMO MODE

In Demo Mode, the normal operation of the cooling fan, circulation fan and lighting work normally, however all heating elements and other functions are disabled.

If the oven is turned off, it will remain in Demo Mode when the oven is turned back on.

When Demo Mode is turned on '**DEMO**' is shown at the top of all screens.

After making your adjustments, select a different setting option from the menu or press the < button to return to the home screen.

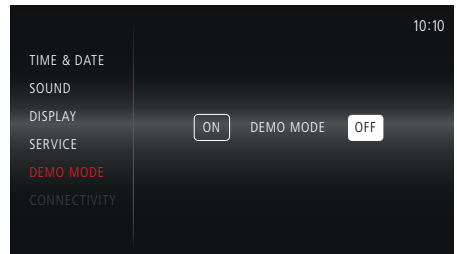
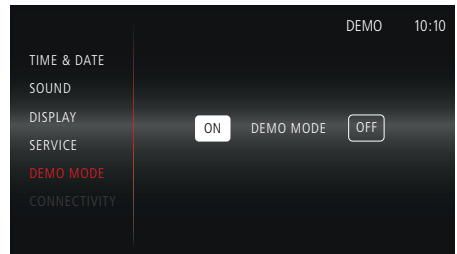

CONNECTIVITY

NOTE:

Download the CapleHome App to your mobile device/tablet, prior to connection setup.

Press to enable WIFI.

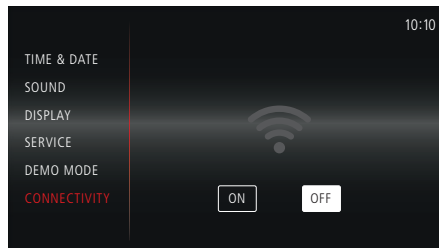

Follow the on-screen prompt to open the CapleHome App and follow instructions on your device to connect to WIFI.

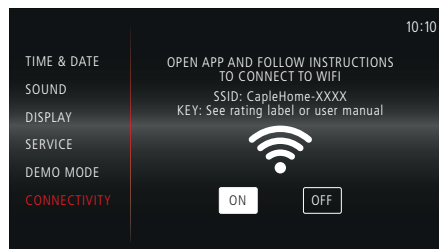

Once the appliance is connected to your mobile device/tablet, **'connected to...'** message will display and the  symbol will appear in the top right corner next to the time.

To disable WIFI press

After making your adjustments, select a different setting option from the menu or press the  button to return to the home screen.

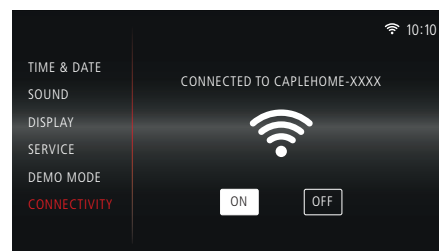















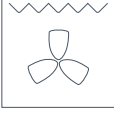

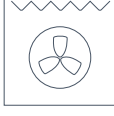



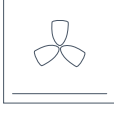



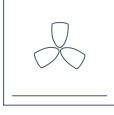

NOTE:



By connecting the appliance to the Caple Home App, you are allowing the appliance to be controlled by the App.

WiFi frequency: 2.4Ghz

OVEN FUNCTIONS

	FAN HEAT	Both the fan and circular heating element operate together for the most even air distribution. This is the ideal cooking method for several types of food (meat & fish, pastries etc).	BOOST 
	FULL GRILL	Both the top heating element and grill element operate together to grill larger quantities of food. Perfect for large pieces of steak or fish, this function should be used with a closed door.	
	ECO GRILL	This function uses just the grill element, and is primarily used for grilling small quantities of food such as bacon or toast. This function should be used with a closed door.	
	TURBO GRILL	The heat which is produced by the top element and grill is circulated by the fan for faster and more even cooking. Perfect for quick browning foods such as potato gratin or lasagne.	
	FAN HEAT & GRILL	This function uses standard fan heat for cooking, with the grill to brown the tops of foods.	BOOST 
	CONVENTIONAL	This function uses top and bottom heating elements simultaneously. Perfect for baking, the static cooking function ensures consistent cooking through to the middle. For the best results use one shelf only.	BOOST 
	TURBO CONVENTIONAL	Fan assisted top and bottom elements for fast and even heat distribution. Ideal for cooking more than one food type without transferring smells or tastes, this function is perfect for light and delicate baking, such as pastry and bread.	BOOST 
	BASE HEAT	This function uses the bottom heating element only, to cook the underside of the food. It is ideal for slow cooking, i.e. casseroles.	BOOST 
	TURBO BASE HEAT	Designed for delicate and slow cooking. Both the fan and the lower heating element operate together. The air which is heated by the lower heating element is circulated by the fan, helping to distribute the heat. Eliminates the need for blind baking.	BOOST 

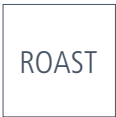
	BASE HEAT & FAN HEAT	The heat produced by the circular and bottom elements is evenly distributed by the fan. This function is ideal for cooking pizza and pastries.	BOOST 
	FAN HEAT & TOP HEAT/BASE HEAT	This function combines Conventional Heat with Fan Heat for intense even cooking.	BOOST 
	DEHYDRATE	This function uses Fan Heat, with a pre-set temperature of 60°C, with options to select 50°C and 70°C. Ideal for drying fruit.	BOOST
	WARM	This function uses Base Heat with a pre-set temperature of 40°C, with options to select 30°C and 50°C. It is ideal for warming plates etc.	BOOST
	WARM +	This function uses Base Heat with a pre-set temperature of 75°C, with options to select 100°C and 50°C. It is ideal for warming plates and keeping food warm.	BOOST
SLOW	SLOW	This function is for slow cooking over a period of time at 90°C using Conventional Heat.	BOOST 
	DEFROST	No heat, fan only. The air at ambient temperature is distributed inside the oven for defrosting food quicker. Perfect for frozen desserts.	
P	PYROLYTIC SELF-CLEANING	The internal temperature of the oven is raised to 475°C, causing even hidden and baked-on grime to carbonise into a fine ash for easy cleaning. Ideal for taking the effort out of cleaning.	
PIZZA	PIZZA	This function uses the Pyrolytic Technology to cook a traditional Italian Pizza at 345°C in around 2min 45sec.	

	SABBATH	Uses Conventional Heat with a selectable time of up to 74 hours, and a selectable temperature of 70°C to 140°C.	
	ROAST	This function uses Fan Heat. Once your chosen temperature is set, the function automatically raises the oven to 250°C. Once reached it will drop to the set temperature.	
	PROVING	This function uses Base Heat at a temperature of 30°C. Ideal for proving dough.	

Symbol indicates feature can be used with relevant function:

 Boost

 Rotisserie

 Meat Probe

NOTE:

These symbols will appear 'grey' on the screen and be non-selectable if they are not available for a specific function.

SPECIAL FUNCTIONS

DEHYDRATE



Dehydrate is pre-set to 60°C, with alternative options of 50°C and 70°C. From here, proceed to select Temperature, **BOOST** if necessary, choose a cooking Duration and/or save to favourites.

Press to start cooking.

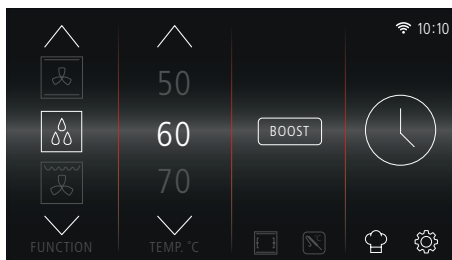

PIZZA

PIZZA

1. Select from the function selection screen, then press .

2. Select Pizza Base and Quantity, then press .

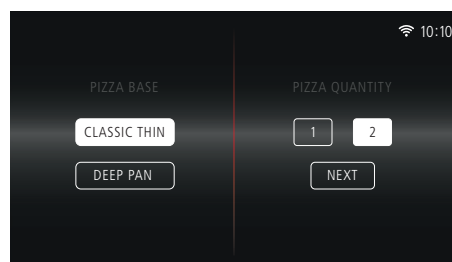
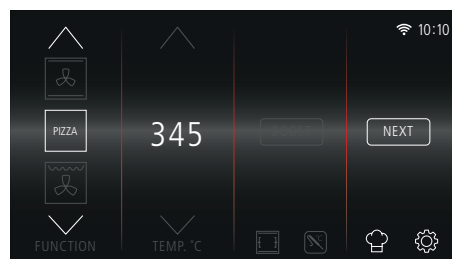

3. From the Cooking Overview screen, you are able to **'EDIT'** and/or **'SAVE'** your cooking selection.

NOTE:

You can only edit the cooking duration on this function. You are unable to edit the temperature.

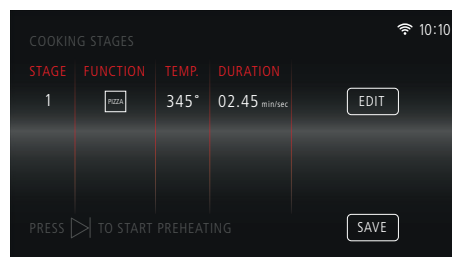

Press **EDIT** to adjust the cooking duration, then press **FINISH** to return to the Cooking Overview screen.

NOTE:

END TIME is unavailable for this function.

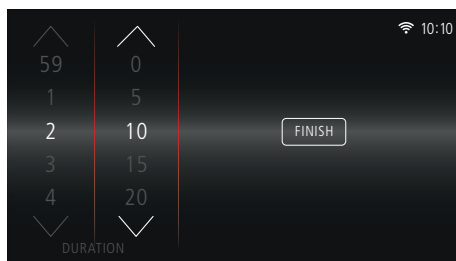



Press **SAVE** to add your cooking selection to favourites. Once the favourite has been named press **SAVE** to return to the Cooking Overview screen.

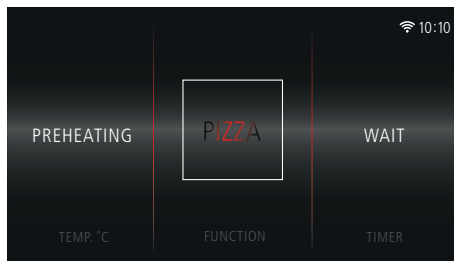

4. Pressing  takes you to the **PREHEATING** screen. The oven will start heating. Do not place your pizza(s) in the oven at this stage.



5. When the oven has reached 345°C, **'READY'** and **'ADD YOUR PIZZA & PRESS **' message will appear. Place your pizza(s) into the oven and press  to start cooking.

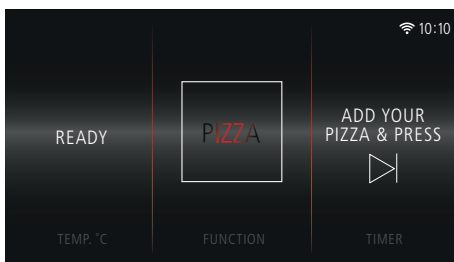

The Main Cooking screen will display.

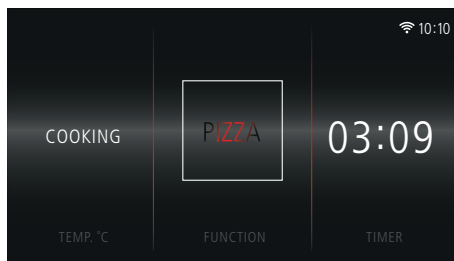

6. When your pizza(s) is finished cooking 'FINISHED! PLEASE REMOVE YOUR PIZZA' message will display.

Press **YES** to return to the **PREHEATING** screen (step 4).

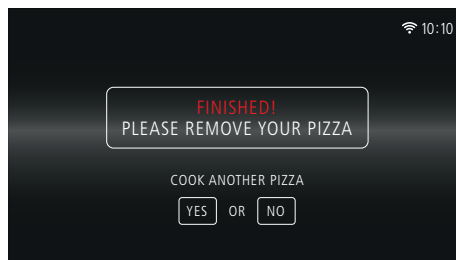

Press **NO** to turn off the appliance. The oven's **RESIDUAL HEAT** will display on the Standby screen.



COOKING SUGGESTIONS:

DEEP PAN		CLASSIC THIN	
1 PIZZA	3:00MIN	1 PIZZA	2:45MIN
2 PIZZA	3:30MIN	2 PIZZA	3:00MIN

PROVING



The Proving function operates at 30°C only.

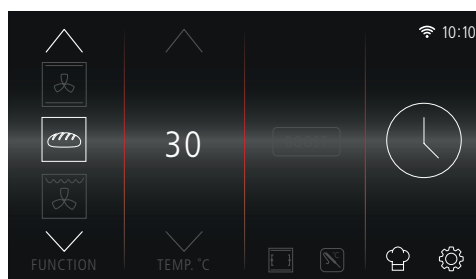

If necessary, select Duration, add addition Cooking Stages and/or save to Favourites.

Press **▶** to start cooking.



ROAST ROAST

Ideal for roasting joints of meat, the Roast function raises the oven to 250°C and once reached will lower to the set temperature; effectively sealing flavours in the meat before cooking.

1. Turn on the oven by pressing the  button.
2. Select ROAST from the Function Selection Screen.
3. Proceed to select **Meat Probe** if necessary, choose a cooking Duration and/or save to favourites.
4. Press  to start cooking.

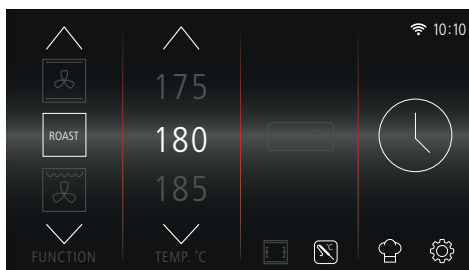

NOTE:

'SEALING' appears above oven temperature until 250°C is reached.

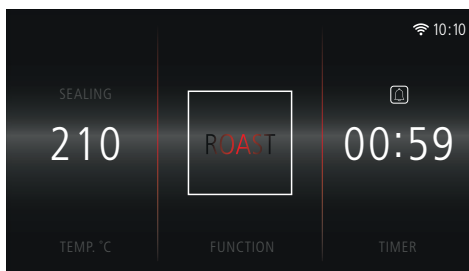

Once 250°C is reached, 'SEALING' turns off and returns to show the actual temperature.

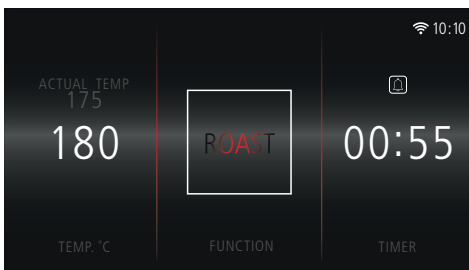

SABBATH S

The Sabbath function can be set up to a maximum of 74 hours.

1. Turn on the oven by pressing the  button.
2. Select S from the Function Selection screen and a cooking Temperature.

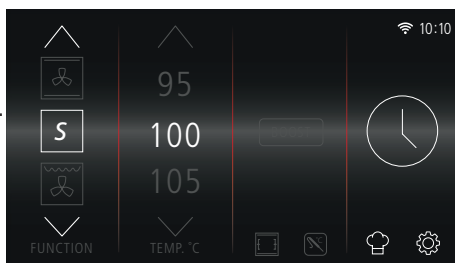



3. In **SABBATH** mode, a duration time must be set. Press  to select a **DURATION** in hours.

Then press FINISH

NOTE:

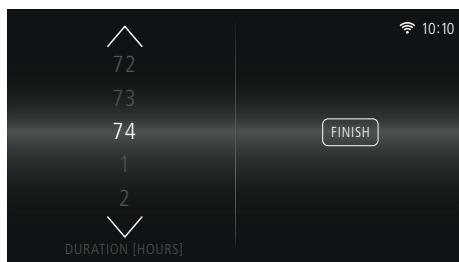
END TIME is unavailable for this function.





4. Press  to start cooking.

SLOW

SLOW

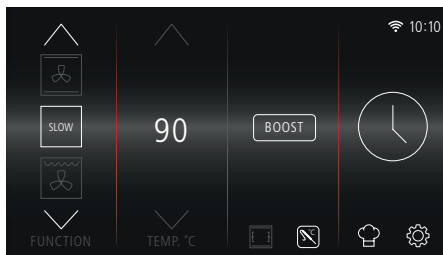

This function is for slow cooking over a period of time at 90°C only.

1. Turn on the oven by pressing the  button.
2. Select  from the Function Selection screen.
3. Proceed to select **BOOST** or **Meat Probe** if necessary choose a cooking Duration and/or save to favourites.
4. Press  to start cooking.



WARM

This function is pre-set to 40°C, with the option to select 30°C or 50°C.

1. Turn on the oven by pressing the  button.
2. Select  from the Function Selection screen.
3. Select a heat of either 30°C, 40°C or 50°C.
4. Proceed to select '**BOOST**' if necessary, choose a cooking Duration and/or save to favourites.

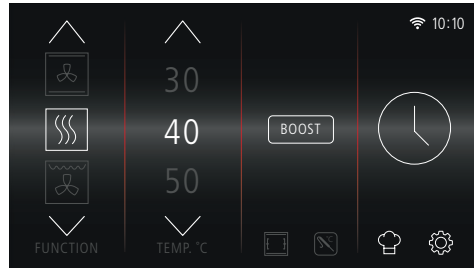



NOTE:

'**BOOST**' is only available when the Temperature is set to 50°C.

5. Press  to start cooking.

WARM+

This function is pre-set to 75°C with the option to select 100°C.

1. Turn on the oven by pressing the  button.
2. Select  from the Function Selection screen.
3. Select a heat of either 75°C or 100°C.
4. Proceed to select **BOOST** if necessary, choose a cooking Duration and/or save to favourites.
5. Press  to start cooking.

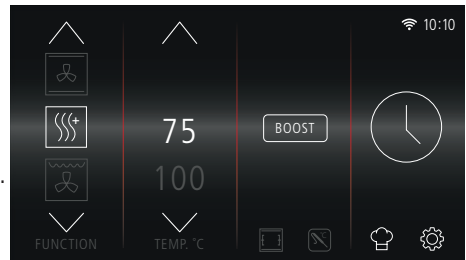

PYROLYTIC CLEANING

P

With the Pyrolytic Clean mode, the internal temperature of the oven reaches 475°C. The pyrolytic cycle is activated, burning away food and grime residues.

CAUTION:

Keep children away from the appliance during the automatic cleaning cycle as surfaces may become very hot.

NOTE:

Particles may ignite inside the oven due to the combustion process. There is no cause for concern: this process is both normal and hazard-free.

Before initiating the **PYROLYTIC CLEANING** mode:

- › Remove large or coarse food residues from the inside of the oven using a damp sponge. Do not use detergents.
- › Clean the inside of the oven door with a damp cloth. This will prevent cooking residue from sticking to the glass.
- › Remove the side racks, telescopic runners, trays and wire shelves.
- › Remove all accessories.
- › Do not place tea towels or pot holders over the oven handle.
- › Ensure any tin foil is removed from the oven cavity.
- › Make sure the room is well ventilated.

NOTE:

The programme may only be started once the oven door has been closed.

› Turn on the oven by pressing the  button.

› Select  from the Function Selection screen.

Select a cycle duration of either 1:15hr, 1:30hr or 2:00hr.

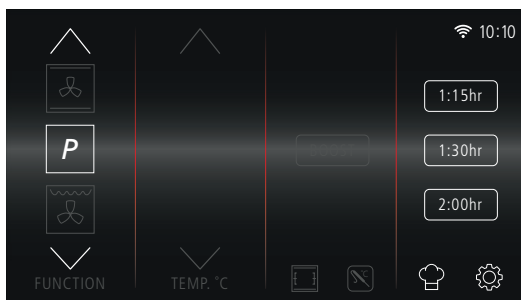

NOTE:

END TIME is unavailable for this function.

› To begin cycle, press 

'WARNING: ENSURE ALL SHELVING AND ACCESSORIES HAVE BEEN REMOVED FROM THE OVEN' message will appear.

Follow the instructions and press  to continue.

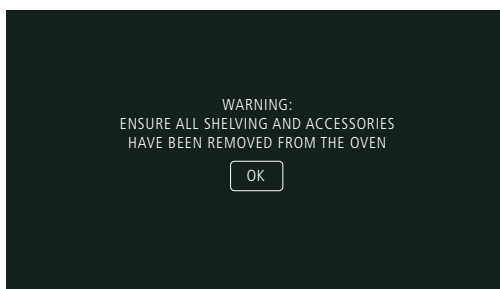

The main Cooking Screen will appear and the Cleaning Cycle will begin.

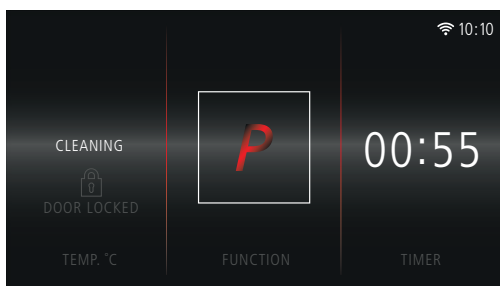

- › When the oven has reached 350°C **'DOOR LOCKED'** message and symbol will appear.

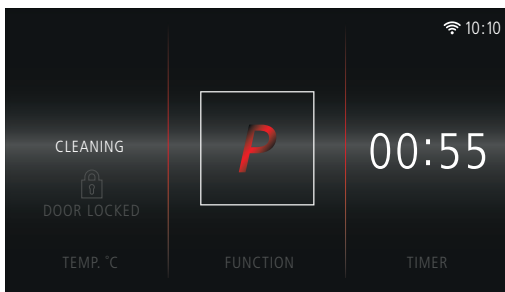

- › When the cycle has finished, the screen will display **'CLEANING COMPLETE'** message.

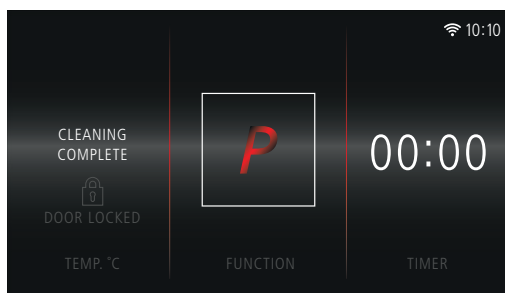

- › If the oven is turned off and enters standby mode, the screen will display **'RESIDUAL TEMP...'** Message and the door will remained locked.



ONCE THE PYROLYTIC CLEANING CYCLE IS OVER

You will have to wait until the temperature inside the oven has cooled down sufficiently before you can open the oven door. You will notice some white dust deposits on the bottom and the sides of your oven; remove these deposits with a damp sponge once the oven has cooled down completely. Alternatively, you can make use of the already heated oven, in which case it is not necessary to remove the deposits as these will not affect your food.

USING THE ROTISSERIE



The Rotisserie turns meat automatically as it cooks, so that it bastes itself. This feature can be used with several programmes in this oven (See OVEN FUNCTIONS).

WARNING:

THE ROTISSERIE SPIT HAS SHARP EDGES AND THERE IS A RISK OF INJURY. ENSURE IT IS KEPT OUT OF THE WAY OF CHILDREN AND THEY DO NOT USE THIS ACCESSORY. ENSURE CAUTION IS USED WHEN HANDLING THE ROTISSERIE SPIT.

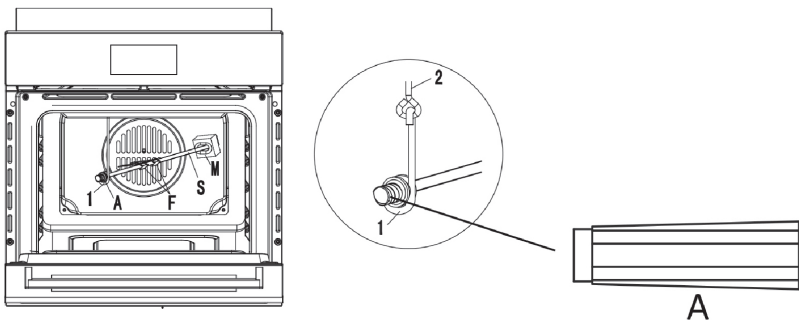



After fitting the food onto the spit, block it with the two forks. Then proceed as follows:

- › Position the spit support as shown in figure 6.
- › Fit the end of the into the motor (M) at the back of the oven.
- › Fit the support into the circular groove in the spit.
- › » Unscrew and remove handle (A).
- › » Place the oven tray with a little water on the lowest shelf of the oven.
- › » Close the oven door.

- › Turn the oven on by pressing the  button.

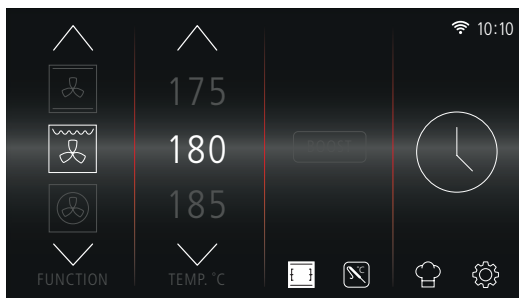
Select a Cooking Function and Temperature, then press 



- › Select a Cooking Duration if necessary, then press . The Rotisserie symbol will display on the Main Cooking Screen.
- › When the cooking time is up, screw the handle on the spit and remove everything from the oven. If necessary, use oven gloves to avoid any burns.

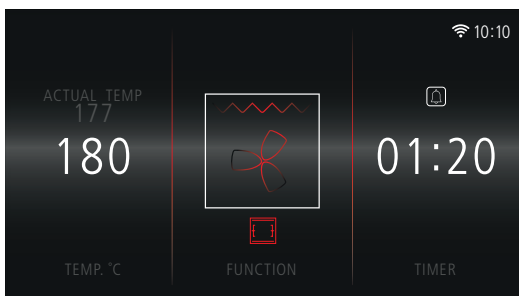



USING THE MEAT PROBE

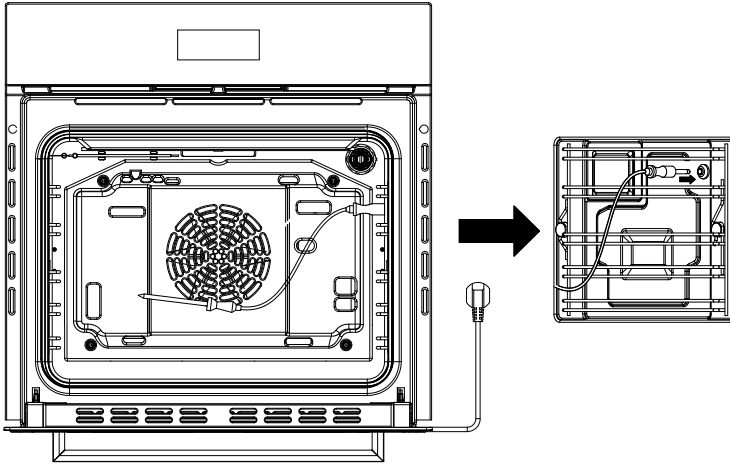

The Meat Probe feature can be used with several programmes in this oven (See OVEN FUNCTIONS).



- › Connect the Meat probe to inside of your oven.
- › Insert the Probe into your chosen meat.
- › Close the oven door.
- › Turn the oven on by pressing the  button.
- › Select a Cooking Function and Temperature, then press 

NOTE:

The  is only available to select if the meat probe has been inserted into the plug inside the oven.

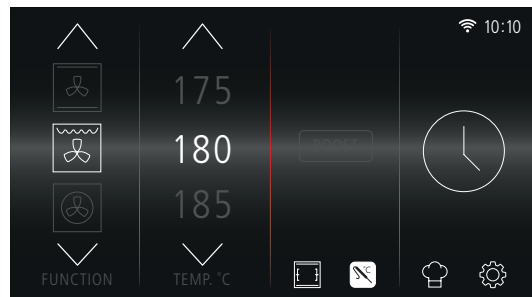

- › Choose a Core Temperature then press **SELECT**

NOTE:

Probe is accurate to 1°C.

NOTE:

A Cooking Duration cannot be set when the Meat Probe is selected. Multi-Stage cooking is unavailable when the Meat Probe is selected.

- › Press  and the Cooking Overview screen appears.

- › Edit selection, Save to Favourites or Press  to start cooking.

- › The Meat Probe symbol will display on the Main Cooking Screen.

- › Core Temperature will be displayed.

- › **'CORE TEMP REACHED'** will display and a tone will sound once desired temperature has been achieved.

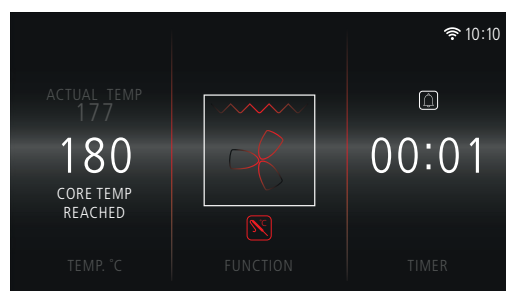
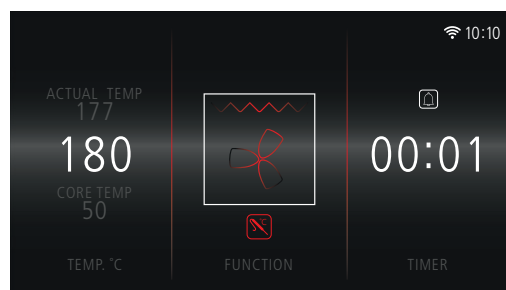
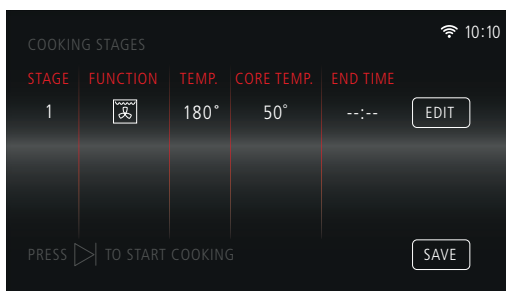
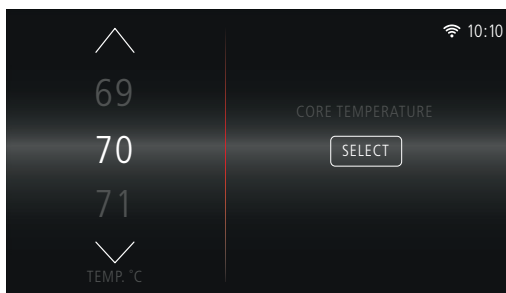

CARE AND MAINTENANCE

IMPORTANT:

Isolate your oven from the electrical supply before cleaning, or performing maintenance. To extend the life of your oven, it must be cleaned frequently, keeping in mind that:

DO NOT USE STEAM EQUIPMENT TO CLEAN THE APPLIANCE

- › To protect against the risk of electrical shock, do not immerse the unit, cord or plug in water or other liquid or sprinkle water to clean the appliance.
- › Don't clean the appliance when it still hot! The inside and external surface of the oven should preferably be cleaned by damp cloth when it is cooled down.
- › Wash all accessories in hot soapy water or in a dishwasher, wipe dry with a paper or cloth towel.
- › If you use your oven for an extended period of time, condensation may form. Dry it using a soft cloth.
- › There is a rubber seal surrounding the oven opening which guarantees its perfect functioning. Check the condition of this seal on a regular basis. If necessary, clean it and avoid using abrasive products or objects to do so. Should it become damaged, please contact Caple service. We recommend you avoid using the oven until it has been repaired.
- › Never line the oven bottom with aluminium foil, as the consequent accumulation of heat could compromise the cooking and even damage the enamel.
- › Clean the glass door using damp cloth and dry it with a soft cloth.
- › Do not use harsh abrasive cleaners or sharp metal scrapers to clean the oven door glass since they can scratch the surface, which may result in shattering of the glass.

REPLACING THE OVEN BULBS

- › Switch off your oven at the mains.
- › Remove the glass cover of the bulb-holder.
- › Remove the light bulb and replace it with a similar one.
- › Remount the glass cover and reconnect the appliance to the power supply.

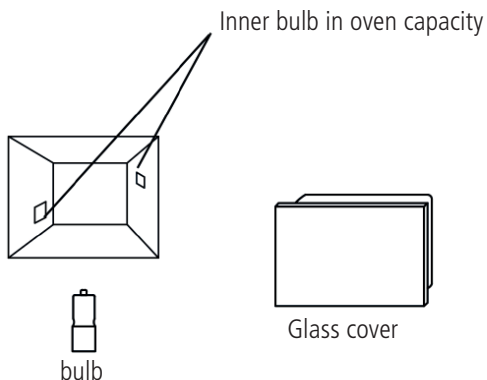

Halogen bulb characteristics:

- › Voltage: AC220V-240V
- › Wattage: 25W
- › Cap: G9

DO NOT TOUCH the light bulb directly with your hands.

WARNING:

Ensure that the appliance is disconnected from the mains before replacing the lamp to avoid the possibility of electric shock.

REMOVING THE OVEN DOOR

To make it easier to clean the inside of your oven, the oven door can be removed by proceeding as follows (Fig. 1-2):

- › Open the door completely and lift the 2 levers "B" (Fig.1);
- › Now, shutting the door slightly, you can lift it out by pulling out the hooks "A" as shown in figure 2.

TO REASSEMBLE THE DOOR

- › With the door in a vertical position, insert the two hooks "A" into the slots;
- › Ensure that seat "D" is hooked perfectly onto the edge of the slot (move the oven door backwards and forward slightly).
- › Keep the oven door open fully, unhook the 2 levers "B" downwards and then shut the door again.

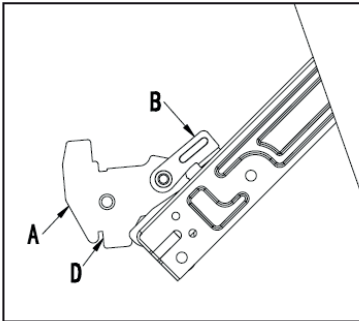

Fig 1

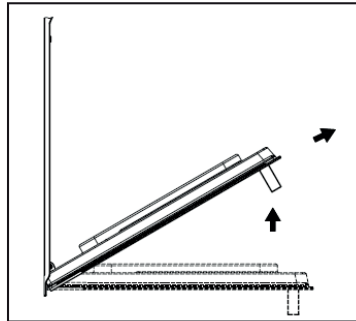

Fig 2

Scan the QR code below to access the 'How to video'.



REMOVING THE GLASS PANELS

The oven door is made up of 4 panes of glass and has vents at the top and bottom. When the oven is operating, air is circulated through the door to keep the outer pane cool. If condensation has worked its way in between the glass panes, the door can be dismantled in order to clean in between the panes. Remove the door as per the below instructions and place it on a protective surface (e.g. on a table cloth) to prevent it getting scratched. The door handle should line up with the edge of the table. Make sure the glass lies flat to avoid breakage of glass during cleaning.

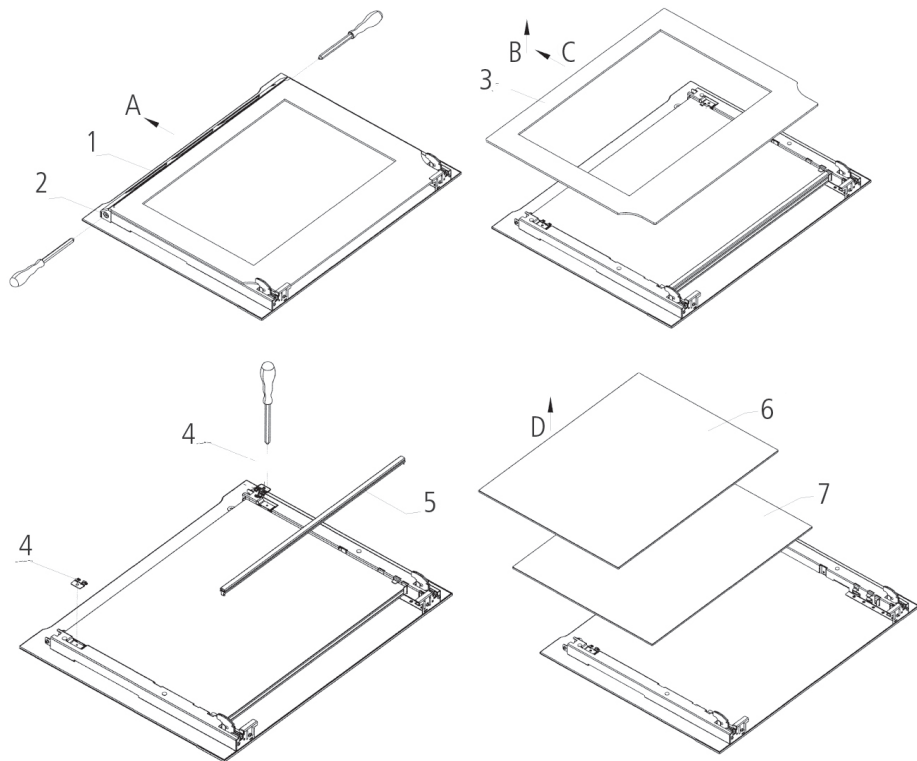

TELESCOPIC RUNNERS

To assemble the telescopic runners:

Remove the side racks (see section below and Fig.2)

- › Choose which shelf to use with the telescopic runner. Paying attention to the direction in which the runner is to be extracted, position joint 'B' and joint 'C' on the frame (see Fig.1).
- › Squeeze the bars together slightly and clip either end of the telescopic runners on to the side racks.
- › Finally, refit the side racks (See below and Fig.2).

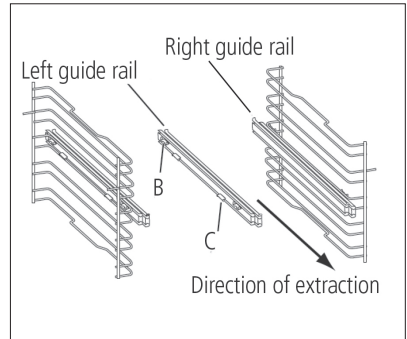

SIDE RACKS

- › Attach the side racks by pushing these onto the furthest steel clip and then clicking the other end onto the closest steel clip.
- › Scan the QR code below to access the '**How to video**'.

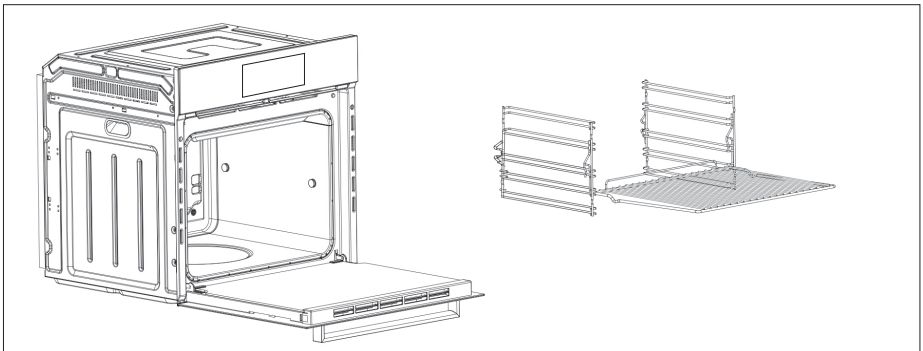

CAPLEHOME APP

Please read carefully through this section to make sure you understand how the App functions.

CONNECTING YOUR OVEN

Download the CapleHome App from www.caple.co.uk or the relevant app store for your device.

When the App is opened for the first time, the **LOGIN/SIGN UP** Screen will appear. Use your details to Sign Up and/or Login.

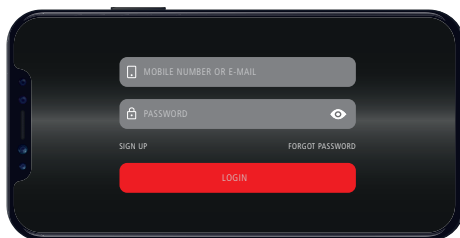

The App Home Screen will display. To begin appliance connection, press 

NOTE:

Make sure WIFI is turned On in your oven settings (page 46). Also make sure your phone or device is connected to your home WIFI network.

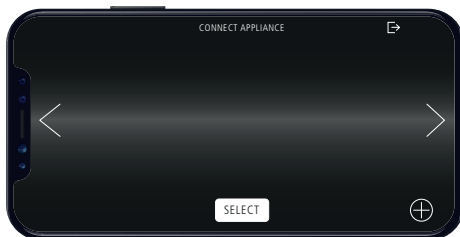

Further instructions on how to connect your appliance to the CapleHome App are available from www.caple.co.uk Or, scan the QR Codes to access the video 'How to guides'.

iOS



Android



Choose to add an additional appliance by repeating previous steps or use the arrows < > to choose the appliance you wish to control. Press **SELECT** to display the Oven's Function Selection Screen.

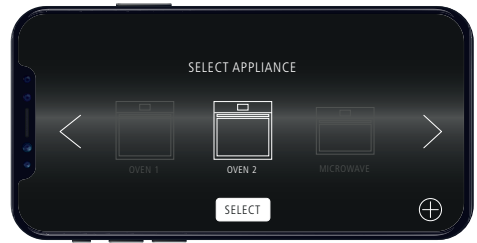

IMPORTANT:

If the Oven WIFI is turned Off, you will need to go through the connection process again.

HOW TO LOG OUT

To Log Out of your CapleHome account go to the App Home screen and press  'ARE YOU SURE YOU WANT TO LOG OUT...' message will appear. Press **'LOGOUT'** to proceed. The login screen will appear.

HOME SCREEN

The CapleHome App is designed to mirror your appliance display:

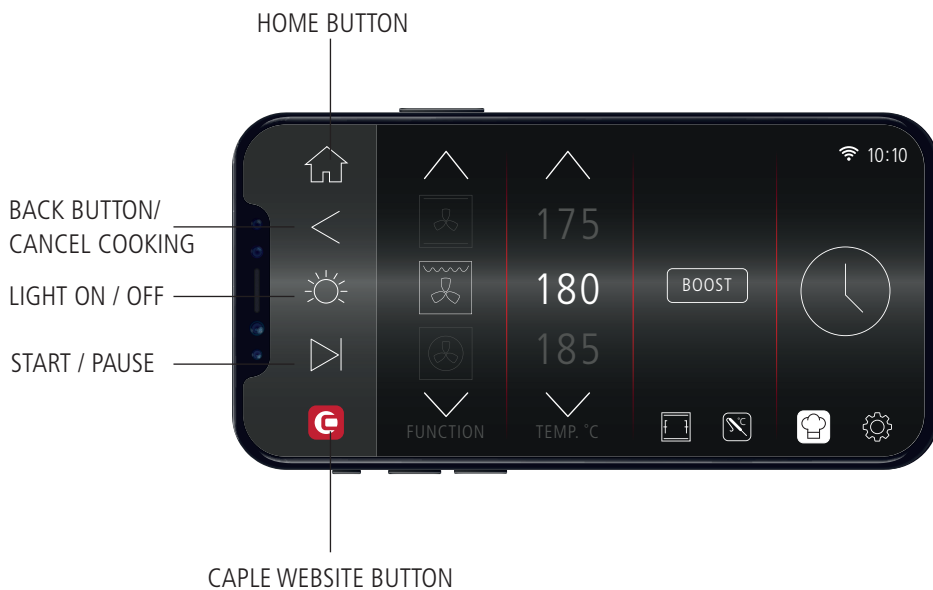

HOME BUTTON

Press to return to the 'SELECT APPLIANCE' screen. From here you can select another appliance you wish to control.

NOTE:

Pressing this button will not cancel cooking.

BACK BUTTON / CANCEL COOKING

Press to return to the previous screen on the display.

Press to cancel cooking.

LIGHT BUTTON

This will appear 'grey' when the internal light is Off. The button will illuminate when the internal light is On.

START/PAUSE BUTTON

After turning the appliance on, select your desired cooking programme and duration and press  to start cooking.

NOTE :

A duration time must be set in order to start cooking via the App. If  is pressed before a duration is set, the appliance will not start cooking.

This is a safety measure to ensure the appliance is not accidentally started via the App, especially if children are playing with it.

CAPLE WEBSITE BUTTON

Takes you to the Caple website where you can also review the Instruction Manual and CapleHome App Connection Guide in digital form if preferred.

FAVOURITES

Cooking selections can be saved to your appliance, the CapleHome App on your chosen device, or both.

To save to Favourites, open the CapleHome App on your device and follow the instructions as detailed in **'SETTING COOKING STAGES AND SAVING TO FAVOURITES'**.

NOTE:

When saving a favourite cooking selection on the CapleHome App or appliance, they do not copy over to the other. For example, if you save a favourite to the App, it will only save there, and not onto the appliance, and vice versa.

If you wish to save the same favourite to your appliance and the App they will have to be entered separately.

LANGUAGE

Several languages are available to choose from whilst operating the CapleHome App.

› To change the language go to , **LANGUAGE**.

› Scroll through the options and then press **SELECT**

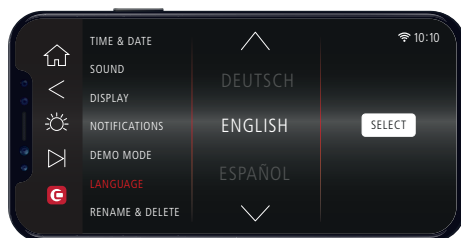

› 'SET LANGUAGE APP WILL RESART...' message will appear. Press 'OK' to continue. The CapleHome App will close, simply open the App again to continue using with the new language.

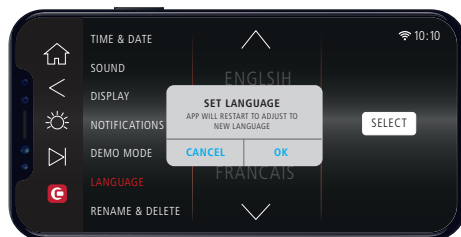

NOTIFICATIONS

From the Function Selection Screen, go to  , **NOTIFICATIONS** to turn notifications On or Off.

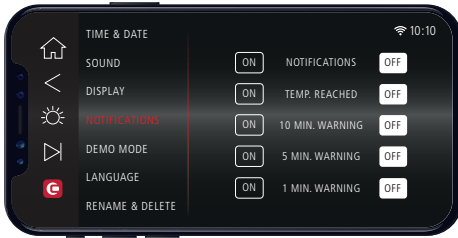

When turned On, notifications will appear outside of the App, on your mobile or smart device.

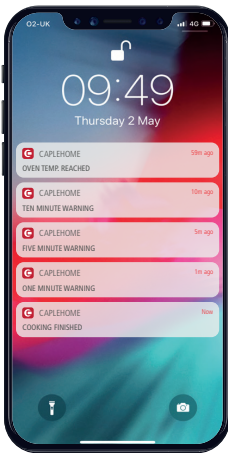

NOTE:

By connecting the appliance to the Caple Home App, you are allowing the appliance to be controlled by the App.

RENAME & DELETE

To rename or delete an appliance from the CapleHome App, proceed as follows:

- › Choose the appliance you want to Rename or Delete from the App Home screen and press **SELECT**

- › Go to  **RENAME & DELETE.**



TO RENAME AN APPLIANCE

- › Click on the existing appliance name (for example 'OVEN 2') and enter a new name.

- › Press **'RENAME'**

- › The new appliance name will appear on the App Home screen.

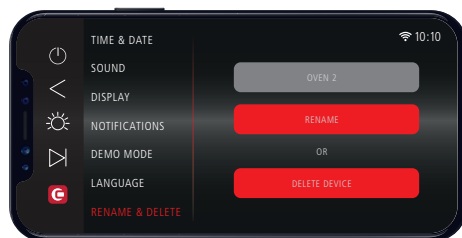

TO DELETE AN APPLIANCE:

- › Press **'DELETE DEVICE'**

- › The deleted appliance will no longer show on the App Home screen.

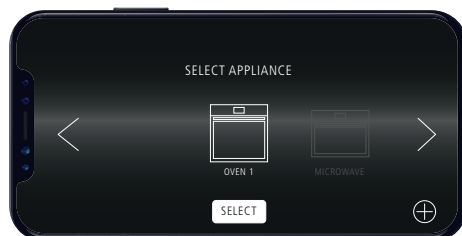

TROUBLESHOOTING

TROUBLE	SOLUTION
The oven does not operate	<ul style="list-style-type: none">» Check it is switched on at the mains» There has been a power cut» The time is not set
The oven is not heating	The thermostat is not turned to a temperature
The interior lamp does not illuminate	<ul style="list-style-type: none">» Check the product is connected to the electrical supply and is switched on» Replace the bulb
Lower and upper parts of the oven are not cooking evenly	Adjust the shelf position, cooking period and temperatures according to the manual

If the problem still persists, please contact Caple service for assistance:

Phone: 0117 938 7420

Email: service@caple.co.uk

USEFUL NOTES FOR COOKING

In the following table, some indicative hints for cooking:

FAULTS	CAUSES	REMEDIES
The upper crust is dark and the lower part too pale	Not enough heat from the bottom	<ul style="list-style-type: none"> » Use the natural convection position » Use deeper cake tins » Lower the temperature » Put the cake on a lower shelf
The lower part is dark and the upper crust too pale	Excessive heat from the bottom	<ul style="list-style-type: none"> » Use the natural convection position » Use lower side tins » Lower the temperature » Put the cake on a higher shelf
The outside is too cooked and the inside not cooked enough	Too high temperature	Lower the temperature and increase the cooking time
The outside is too dry even though it is the right colour	Too low temperature	Increase the temperature and reduce the cooking time.

ERROR CODES

ERROR CODE	ERROR	REASON
ER01	Thermostat not detected.	No thermostat detected or high temperature detected. The oven will stop heating and turn the cooling fan on.
ER02	Thermostat short circuit.	Very low temperature. The oven will stop heating and turn on the cooling fan.
ER03	Temperature detected by the Meat Probe is $\geq 105^{\circ}\text{C}$.	The temperature detected is higher than normal; the Meat Probe may be in the oven without being inserted into food. Error code will reset when the Meat Probe is removed.
ER04	Door lock not engaging.	When using the Pyrolytic function, the door lock has failed to activate when the cavity has reached the required temperature. If this is detected for 3 minutes the heating elements will switch off. Contact Caple Service.

If the problem still persists, please contact Caple service for assistance:

Phone: 0117 938 7420

Email: service@caple.co.uk



Caple Service
Fourth Way
Avonmouth
Bristol
BS11 8DW

T: 0117 938 1900
E: service@caple.co.uk
www.caple.co.uk