



# Sense Single Oven Instruction Manual

---

# C2105, C2105SS, C2106GM



Contact Caple on 0117 938 7420 for spare parts or [www.caple.co.uk](http://www.caple.co.uk)

# CONTENTS

---

Safety Warnings	3
Installation Warnings	7
Environmental Protection	10
Warranty	10
Installation	12
Oven Dimensions	13
Electrical Connection	14
Control Panel and Display	15
Operation	16
Oven Functions	18
Demo Mode	19
Using the Rotisserie	20
Telescopic Runners	21
Care and Maintenance	22
Replacing the Oven Lamps	23
Troubleshooting	24
Removing the Oven Door	25
Removing the Glass Panels	26
Caple Contact Details	28

# SAFETY INSTRUCTIONS

Read these instructions carefully and completely before using your appliance, keep it in a convenient place for reference when necessary.

- This appliance can be used by children aged from 8 years and above.
- Persons with reduced physical, sensory or mental capabilities or lack of experience and knowledge must be supervised and given appropriate instruction concerning the use of the appliance in a safe way and understand the hazards involved.
- Children shall not play with the appliance.
- Cleaning and user maintenance should not be carried out by children without supervision.
- The appliance is not intended to be operated by means of an external timer or separate remote control system.

## **WARNING:**

- The appliance and its accessible parts become hot during use. Care should be taken to avoid touching heating elements.
- Children less than 8 years of age should be kept away unless continuously supervised.
- To prevent fire hazards do not store items on the cooking surfaces.
- During use, handles can get hot.
- Do not use harsh abrasive cleaners or sharp metal scrapers to clean the oven door glass or any other surface of the appliance as it can scratch the surface which may result in the glass shattering or permanent damage to the surface.
- Do not use steam cleaners for cleaning the appliance.
- Ensure the appliance is switched off before replacing the lamp to avoid the possibility of electric shock.

## **CAUTION:**

- Accessible parts may be hot when the cooking or grilling is in use. Young children should be kept away.
- Your appliance is produced in accordance with all applicable local and international standards and regulations.
- Maintenance and repair work must be made only by authorised Caple service technicians. Installation and repair work that is carried out by unauthorised technicians may endanger you.
- It is dangerous to alter or modify the specifications of the appliance in any way.
- Prior to installation, ensure that the local distribution conditions (electricity voltage and frequency) and the requirements of the appliance are compatible. The requirements for this appliance are stated on the rating label.
- This appliance is designed only for cooking food and is intended for indoor use.

- This appliance is intended to be used in household and similar applications such as:
  - Staff kitchen areas in shops, offices and other working environments
  - Farm Houses
  - By clients in hotels, motels and other residential type environments
  - Bed and breakfast type environments
- Do not try to lift or move the appliance by pulling the door handle.
- All possible security measures have been taken to ensure your safety. Since the glass may break, you should be careful while cleaning to avoid scratching.
- Avoid hitting or knocking on the glass with accessories.
- Ensure that the supply cord is not wedged or trapped during the installation. If the supply cord is damaged, it must be replaced by a Caple service technician or similarly qualified persons in order to prevent a hazard.
- While the oven door is open, do not let children climb on the door or sit on it.

## INSTALLATION WARNINGS

- Do not operate the appliance before it is fully installed.
- The appliance must be installed by an authorised technician.
- Caple is not responsible for any damage that may be caused by defective placement and installation by unauthorised persons.
- When unpacking the appliance, make sure that it is not damaged during transportation. In the case of any defect; do not use the appliance and contact your retailer or Caple Service immediately.
- Materials used for packaging (nylon, staplers, styrofoam etc) may cause harmful effects to children they should be disposed of immediately.
- Protect your appliance against atmospheric effects. Do not expose it to effects such as sun, rain, snow etc.
- The surrounding materials of the appliance (i.e. kitchen cabinet or furniture) must be able to withstand a minimum temperature of 120°C.

## DURING USAGE

- Before using the oven for the first time, heat the empty oven at max. temperature for 1 hour – removing any unpleasant smells and smoke caused by working residues and thermal insulation. Make sure you do this in a well ventilated area.
- During usage, the outer and inner surfaces of the oven get hot. While opening the oven door, step back to avoid the hot steam coming out of the oven as there may be a risk of burns.
- Do not put flammable or combustible materials in or near the appliance when it is operating.
- Always use oven gloves to remove and replace food in the oven.
- Pay close attention to the oven while cooking with solid or liquid oils as they could potentially catch fire when oven is hot.
- Never pour water on flames that are caused by oil. Cover the saucepan or frying pan with its lid in order to choke the flame and turn the oven off.
- If you know you will not be using the appliance for a while switch it off from the mains supply.
- The oven shelves and trays incline when pulled out. Be careful not to let hot liquid spill over.

- When the door of the oven is open, do not leave anything on it. It may unbalance your appliance or damage the door.
- Do not put anything heavy, flammable or ignitable (nylon, plastic bag, paper or cloth etc) into the oven. This includes cookware with plastic accessories (e.g. handles). Do not hang towels, dishcloths or clothes from the appliance or its handles.
- Do not use the oven for storage purposes.
- Do not touch the appliance with wet hands.
- Do not obstruct the ventilation openings.
- Do not allow supply cords from other small appliances to come into contact with the oven.

## **DURING CLEANING AND MAINTENANCE**

- Always switch off the appliance from the mains isolating the electrical supply before any cleaning or maintenance.
- To maintain the efficiency and safety of your appliance, we recommend you always use original spare parts and to call only our authorised Caple Service agents in case of need.



## ENVIRONMENTAL PROTECTION

Waste electrical products should not be disposed of with household waste. Please recycle where facilities exist. Check with your Local Authority or retailer for recycling advice.

This appliance is marked according to the European directive on Waste Electrical and Electronic Equipment (WEEE). By ensuring this product is disposed of correctly, you will help prevent potential negative consequences for the environment and human health, which could otherwise be caused by inappropriate waste handling of this product. The symbol on the product indicates that this product may not be treated as household waste. Instead it shall be handed over to the applicable collection point for the recycling of electrical and electronic equipment. Disposal must be carried out in accordance with local environmental regulations for waste disposal.

For more detailed information about treatment, recovery and recycling of this product, please contact your local council, your household waste disposal service or the retailer where you purchased the product.

## TECHNICAL FICHE

This appliance conforms to all current and applicable energy regulations. To view the technical fiche that supports the energy labelling data, please visit the product page on our website [www.caple.co.uk](http://www.caple.co.uk).

## WARRANTY

Your new appliance is covered by warranty. The warranty card is enclosed - if it is missing, you must provide the following information to your retailer in order to receive a replacement: date of purchase, model and serial number. Registration can also be completed online by visiting [www.caple.co.uk](http://www.caple.co.uk).

Ensure you keep your warranty card safe, you may need to show it to Caple Service together with proof of purchase.

If you fail to show your warranty card you will incur all repair charges.

Spare parts are only available from Caple Service and spare parts authorised centres.

## **ATTENTION**

Before use, remove all plastic films protecting some parts of the appliance (fascia - panel, parts in stainless steel, etc)

Do not use the appliance to heat a room.

When the appliance is not in use, we recommend you turn it off, and isolate it from the electrical supply.

## **CE DECLARATIONS OF CONFORMITY**

This appliance has been designed, constructed and marketed in compliance with safety requirements in force. This appliance has been manufactured to the strictest standards and complies with all applicable legislation.

## **UKCA DECLARATIONS OF CONFORMITY**

This appliance has been manufactured to the strictest standards and complies with all applicable legislation.

## INSTALLATION

### IMPORTANT:

### ISOLATE YOUR OVEN FROM THE ELECTRICAL SUPPLY BEFORE PERFORMING INSTALLATION OR MAINTENANCE.

Installation should be carried out according to the instructions by a professionally qualified person only.

The manufacturer declines all responsibility for any damage to persons, animals or materials due to incorrect installation.

## FITTING THE APPLIANCE

Fit the appliance into its surround (beneath a worktop or above another appliance in a tall housing) by inserting screws and plastic covers into the 2 holes (A - fig.3) that can be seen in the frame of the oven when the door is open.

For the most efficient air circulation, the oven should be fitted according to the dimensions shown in fig. 1 & 2.

The rear panel of the cabinet must be removed so that air can circulate freely. The panel to which the oven is fitted should have a gap of at least 50mm at the rear for ventilation (fig.4 & fig.5).

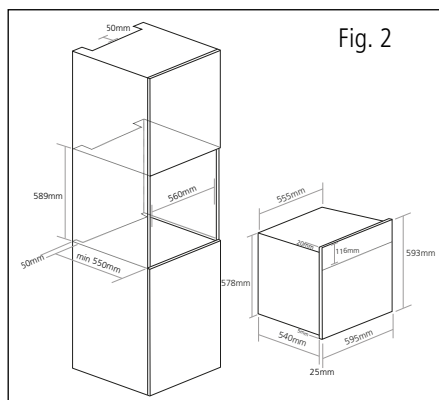
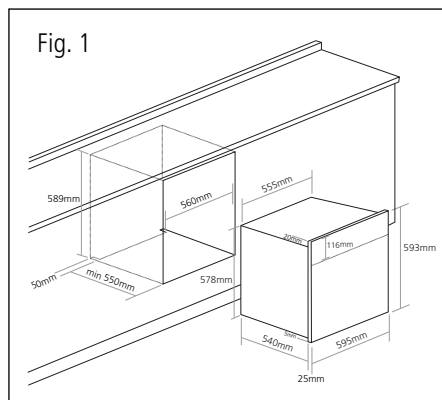
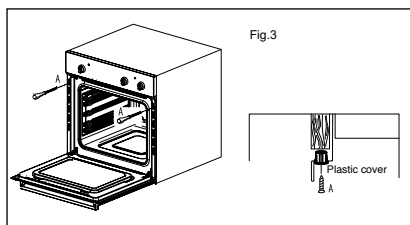

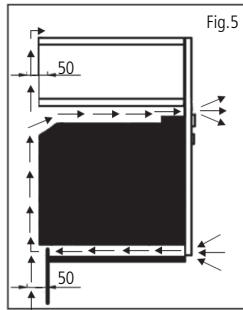
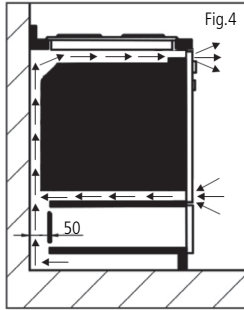

See below for full dimensional drawings of your oven to help with installation.

For a built-in oven to work well the cabinet must be of the right type.

The panels of the adjoining furniture should be heat resistant. Particularly when the adjoining furniture is made of veneered wood, the adhesives should be able to withstand a temperature of 120°C. Plastic materials or adhesive which cannot withstand this temperature may become deformed or unstuck.

To comply with safety regulations, once the appliance has been fitted it should not be possible to make contact with the electrical parts.

All parts which offer protection should be fixed in such a way that they cannot be removed without the use of a tool.

## OVEN DIMENSIONS

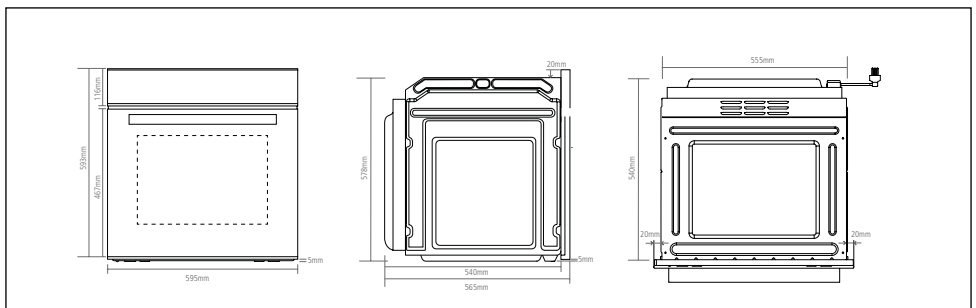

## ELECTRICAL CONNECTION

---

### **WARNING: THIS APPLIANCE MUST BE EARTHED**

Check that the power rating of the mains supply is suitable for the maximum power of the appliance as indicated on the rating label.

The fuse rating for this appliance is 16amp.

The appliance is supplied with a mains lead it should be "Hard wired" as follows:

- › The "yellow/green" earth wire, which must be connected to a terminal, and has to be about 10mm longer than the other wire.
- › The neutral wire has to be connected to the terminal marked with a letter N.
- › The Live wire should only be connected to the terminal marked L.

Mains connection can also be made by fitting a double pole switch with a minimum gap between the contacts of 3mm, proportionate to the load and complying with the regulations in force.

### **THE YELLOW/GREEN EARTH WIRE SHOULD NOT BE CONTROLLED BY THE SWITCH.**

When a double pole switch is used for mains supply connection it should be easily accessed, once the appliance is in position.

### **IMPORTANT:**

The mains supply cable should be positioned so that it is never subjected to temperatures which are more than 50°C above ambient temperature.

The electrical safety of the appliance can only be guaranteed when it has been correctly connected to a properly earthed mains electrical supply, as laid down in the current regulations for electrical safety.

The manufacturer cannot be held responsible for any damage to persons or objects due to lack of an earth connection.

The ovens are designed to operate with a mono-phase alternating current of 220-240V, 50Hz.

### **BEFORE THE INSTALLATION OF THE APPLIANCE, CHECK THE SPECIFICATIONS ON THE RATING LABEL.**

## CONTROL PANEL AND DISPLAY

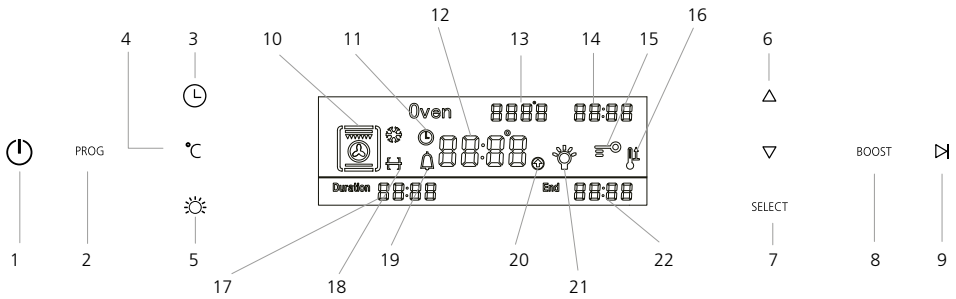

### BUTTON DESCRIPTION      DISPLAY DESCRIPTION

1. Power	10. Function / programme	17. Cooking Duration Time
2. Programme	11. Timer	18. Rotisserie
3. Timer	12. Actual Temperature/Time	19. Alarm
4. Temperature	13. Set Temperature	20. Heating Indicator
5. Light	14. Current Time	21. Light
6. Up / Down (+/-)	15. Safety Lock	22. Cooking End Time
7. Select	16. Boost	
8. Boost		
9. Start / Pause		

## ACCESSORIES

2 x Chrome oven shelves

1 x Grill pan with rack and handle

2 x Telescopic runners (x2 pairs)

1 x Rotisserie

To purchase additional or replacement accessories, please visit [www.caple.co.uk](http://www.caple.co.uk)

## OPERATION

### POWER BUTTON

To turn on/off the display panel. When turned on, the time of day will be shown.

### PROGRAMME BUTTON

Press to shift between functions. When you shift to a new function, the current function will stop and the cooking time must be reset. The Function list is as per the below order:

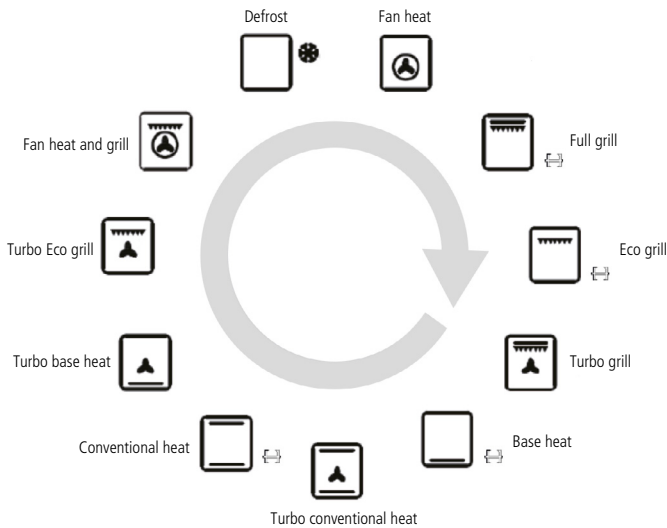

### START/PAUSE BUTTON

Once the required function has been selected, press  to start cooking. Once cooking has started the display will show the current oven temperature. For example;



When the oven is paused, the display will show the current time. For example;

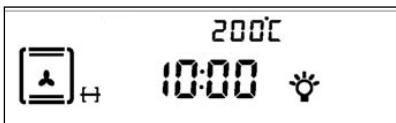

## TIMER BUTTON

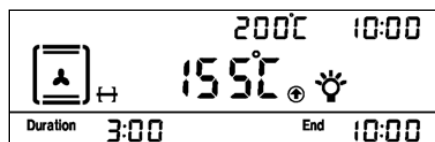

### SETTING THE TIME

Press for 3sec to set current time. Adjust time by pressing + / - .and press **SELECT** to confirm setting.

### SETTING TIMER

Press  to bring up **DURATION**. The display will flash "0:00". Adjust time by pressing + / - and then press **SELECT** to set the duration. Once the time is up, an alarm will sound and the oven will switch off. Press any button to cancel the alarm. If you wish to cancel the alarm before it sounds, set time back to "0:00" to cancel.

### AUTOMATIC COOKING

Once the **DURATION** time has been set, press the  until the **END** time starts to flash. Adjust the end time by pressing + / - and press **SELECT** to confirm. Oven start time = End time – Duration time.

### SAFETY LOCK

Pressing **SELECT** for 5 seconds to enter or cancel the safety lock function.

### TEMPERATURE SETTING.

Once the function is selected, press °C to set the temperature. Adjust temperature by pressing + / - and press **SELECT** to confirm. Press the  button to then start cooking.

### BOOST FUNCTION



If temperature is set to more than 100°C, you can press this key to heat up oven faster. Once activated the display will show 

The Boost function will stop when the oven gets to the required temperature.

### LIGHT FUNCTION













Press the light button to turn the internal oven light on/off. The light will automatically turn off if no operation in 3 minutes.

### SETTING THE ALARM/MINUTE MINDER.

By pressing the  button twice, this takes you to the minute minder function and the  will appear. Press the + / - button to select the time and press **SELECT** to confirm. Once the time runs out an alarm will sound, press any button to turn the alarm off. The oven will continue to run.

## OVEN FUNCTIONS

Press the programme button continuously to scroll through the below functions.

	<b>LIGHTS</b>	Press the light button on the control panel to switch the internal oven lights on and off. The light symbol will show on the display when turned on.
	<b>DEFROST</b>	The air at ambient temperature is distributed inside the oven for defrosting food quicker.
	<b>FULL GRILL</b>	Both the top heating element and grill element operate together to grill larger quantities of food. The door must always be closed for this function.
	<b>FAN HEAT</b>	Both the fan and circular heating element operate together for the most even air distribution. This is the ideal cooking method for several types of food (meat & fish, pastries etc).
	<b>ECO GRILL</b>	This function uses just the grill element, and is primarily used for grilling small quantities of food. This function should be used with a closed door.
	<b>FAN HEAT &amp; GRILL</b>	This function uses standard fan heat for cooking with the grill to brown the tops of foods.
	<b>CONVENTIONAL HEAT</b>	This function uses top and bottom heating elements simultaneously. The static cooking function ensures even cooking of the lower and upper food. This is ideal for making pastries, cakes, baked pasta, lasagne and pizza. It is best to cook on only one shelf at a time in this function.
	<b>TURBO GRILL</b>	The heat which is produced by the top element and grill is circulated by the fan for faster and more even cooking.
	<b>TURBO BASE HEAT</b>	Both the fan and the lower heating element operate together. The air which is heated by the lower heating element is circulated by the fan helping to distribute the heat between 50 and 200°C. This function can be used for sterilising glass jars.
	<b>TURBO CONVENTIONAL HEAT</b>	This function uses both top and bottom heating elements simultaneously. The heat produced by these is then circulated around the oven by the fan to help distribute the heat more evenly.
	<b>BASE HEAT</b>	This function uses the bottom heating element only to cook the underside of the food. It is ideal for slow cooking, i.e. casseroles.
	<b>TURBO ECO GRILL</b>	Using just the grill element, the heated air is then circulated around the oven by the fan for faster and more even cooking.



### NOTE:

All functions with the rotisserie symbol  can use this function by inserting the rotisserie rod into the rotisserie motor at the back of the oven (see 'using the rotisserie'.)

## DEMO MODE

---

### TO TURN ON DEMO MODE:

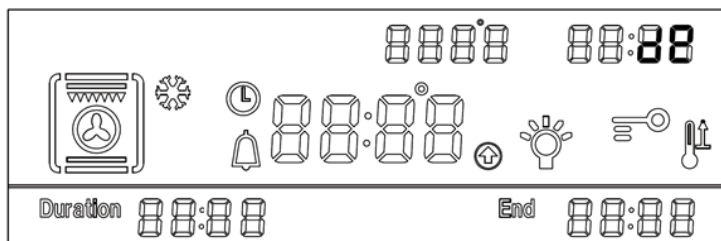

Press the  button to turn the oven on (in standby mode). Press and hold the  button for 5 seconds. The alarm will beep 3 times, and **dE** will appear in the top right of the display to confirm the oven has entered demo mode.



In demo mode, the normal operation of the cooling fan, circulation fan, and lighting work normally, however all heating elements and other functions are disabled.

If the oven is turned off, it will remain in Demo mode when the oven is turned back on.

### TO TURN OFF DEMO MODE

Press the  button to enter standby mode, then press and hold the  button for 5 seconds. The alarm will beep 3 times, and the **dE** will disappear from the display to confirm the system has exited Demo mode, and is ready for normal use.

## USING THE ROTISSERIE

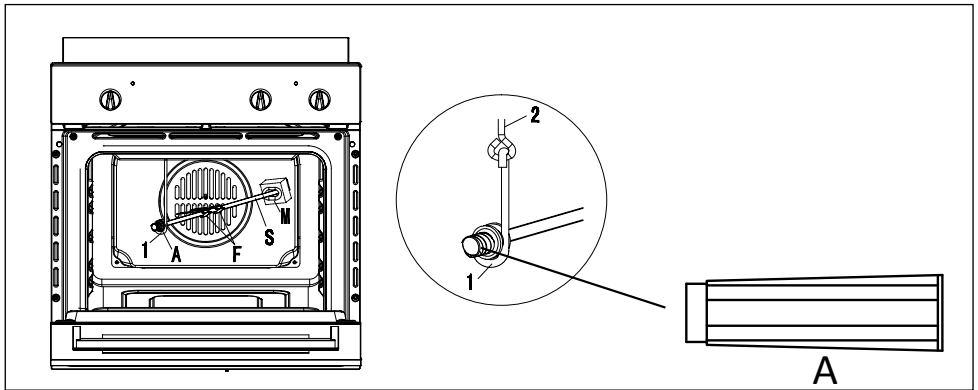

Fig 6

The rotisserie function can be used in a number of programmes on this oven (see page 18.) After fitting the food on to the spit (S), block it with the two forks (F), then proceed as follows:

- › Position the spit support as shown in (fig. 6)
- › Fit the end of the spit into the motor M at the back of the oven.
- › Fit the support into the circular groove in the spit.
- › Unscrew and remove handle A.
- › Place the oven tray with a little water on the lowest shelf of the oven.
- › Close the oven door.
- › When the cooking time is up, screw the handle on the spit and remove everything from the oven. If necessary, use an oven glove to avoid any burns.

## TELESCOPIC RUNNERS

To assemble the telescopic runners:

- › Remove the side racks.
- › Choose which shelf to use with the telescopic runner. Pay attention to the direction in which the runner is to be extracted, position joint 'B' and joint 'C' on the frame (see Fig.1).
- › Squeeze the bars together slightly and clip either end of the telescopic runners onto the side racks.
- › Finally, re-fit the side racks as per below.

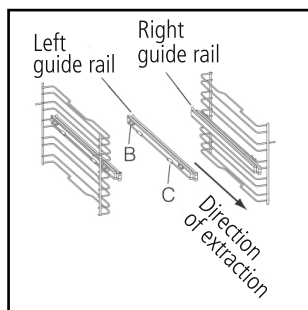

Fig 1.

## SIDE RACKS AND CATALYTIC LINERS

To install, align the 2 holes in the catalytic liners with the 2 steel clips in the side of the oven cavity. Once aligned, attach side racks by pushing these onto the furthest steel clip and then clicking the other end onto the closest steel clip.

This will secure the catalytic liners to the sides of the oven. To remove, unclip the side racks from the side of the oven, and remove the catalytic liners.

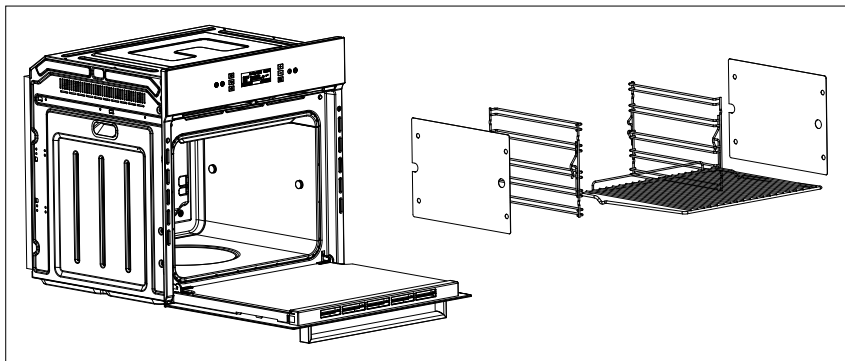

Fig 2.



Scan the QR code to access the 'How to video'.

## CARE AND MAINTENANCE

---

### **IMPORTANT:**

Unplug your oven before cleaning, or performing maintenance!

To extend the life of your oven, it must be cleaned frequently, keeping in mind that:

### **DO NOT USES STEAM EQUIPMENT TO CLEAN THE APPLIANCE**

- › To protect against the risk of electrical shock, do not immerse the unit, cord or plug in water or other liquid or sprinkle water to clean the appliance.
- › Don't clean the appliance when it still hot. The inside and external surface of the oven should preferably be cleaned by damp cloth when it is cooled down.
- › Wash all accessories in hot soapy water or in a dishwasher, wipe dry with a paper or cloth towel.
- › If you use your oven for an extended period of time, condensation may form. Dry it using a soft cloth.
- › There is a rubber seal surrounding the oven opening which guarantees its perfect functioning. Check the condition of this seal on a regular basis. If necessary, clean it and avoid using abrasive products or objects to do so. Should it become damaged, please contact Caple service. We recommend you avoid using the oven until it has been repaired.
- › Never line the oven bottom with aluminium foil, as the consequent accumulation of heat could compromise the cooking and even damage the enamel.
- › Clean the glass door using damp cloth and dry it with a soft cloth.
- › Do not use harsh abrasive cleaners or sharp metal scrapers to clean the oven door glass since they can scratch the surface, which may result in shattering of the glass.

## REPLACING THE OVEN LAMPS

---

- › Switch off your oven at the mains.
- › Remove the glass cover of the lamp-holder
- › Remove the light bulb and replace it with a similar one

### Halogen lamp characteristics

- › Voltage: AC220V-240V
- › Wattage: 25W
- › Cap: G9

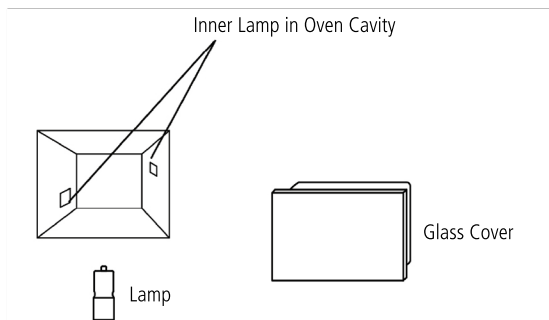

- › Remount the glass cover and reconnect the appliance to the power supply.

**DO NOT TOUCH** the light bulb directly with your hands.

### **WARNING:**

Ensure that the appliance is disconnected from the mains before replacing the lamp to avoid the possibility of electric shock.

## TROUBLESHOOTING

---

The oven does not operate	Check it is switched on at the mains There has been a power cut The time is not set
The oven is not heating	The thermostat is not turned to a temperature
The interior lamp does not illuminate	Check the product is connected to the electrical supply and is switched on Replace the bulb
Lower and upper parts of the oven are not cooking evenly	Control the shelf location, cooking period and temperatures according to the manual

## USEFUL NOTES FOR COOKING

---

In the following table, some indicative hints for cooking:

<b>FAULTS</b>	<b>CAUSES</b>	<b>REMEDIES</b>
The upper crust is dark and the lower part too pale	Not enough heat from the bottom	<ul style="list-style-type: none"> <li>- Use the natural convection position</li> <li>- Use deeper cake tins</li> <li>- Lower the temperature</li> <li>- Put the cake on a lower shelf</li> </ul>
The lower part is dark and the upper crust too pale	Excessive heat from the bottom	<ul style="list-style-type: none"> <li>- Use the natural convection position</li> <li>- Use lower side tins</li> <li>- Lower the temperature</li> <li>- Put the cake on a higher shelf</li> </ul>
The outside is too cooked and the inside not cooked enough	Too high temperature	Lower the temperature and increase the cooking time
The outside is too dry even though it is the right colour	Too low temperature	Increase the temperature and reduce the cooking time.

## REMOVING THE OVEN DOOR

---

To make it easier to clean the inside of your oven, the oven door can be easily removed, by proceeding as follows (fig. 11):

- › Open the door completely and lift the 2 levers "B" (fig.11-1);
- › Now, shutting the door slightly, you can lift it out by pulling out the hooks "A" as shown in fig 2.

## TO REASSEMBLE THE DOOR

---

- › With the door in a vertical position, insert the two hooks "A" into the slots;
- › Ensure that seat "D" is hooked perfectly onto the edge of the slot (move the oven door backwards and forward slightly);
- › Keep the oven door open fully, unhook the 2 levers "B" downwards and then shut the door again.

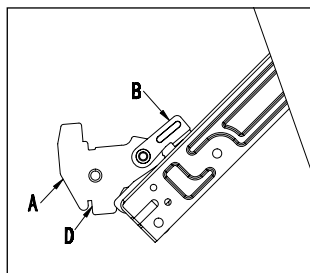

Fig.11-1

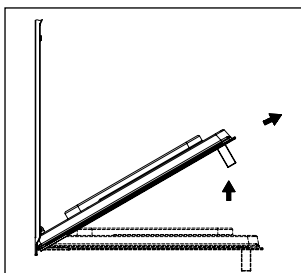

Fig.11-2

Scan the QR code below to access the 'How to video'.



## REMOVING THE GLASS PANELS

The oven door is made up of 3 panes of glass and has vents at the top and bottom. When the oven is operating, air is circulated through the door to keep the outer pane cool. If condensation has worked its way in between the glass panes, the door can be dismantled in order to clean in between the panes. Remove the door as per above instruction and place it on a protective surface (e.g. on a table cloth) to prevent it getting scratched. The door handle should line up with the edge of the table. Make sure the glass lies flat to avoid breakage of glass during cleaning.

1. Press the button on left and right side of door (A), take out top rail pulling in direction B (Fig.1)
2. Take out inner glass slowly (Fig.2)
3. Loose clips (D) by unscrewing. (Fig.3)
4. Take out middle glass. (Fig.4)the door again.

Clean the glass panes and other parts with a damp microfibre cloth or a clean sponge and a solution of hot water with a little washing-up liquid. Wipe dry using a soft cloth.

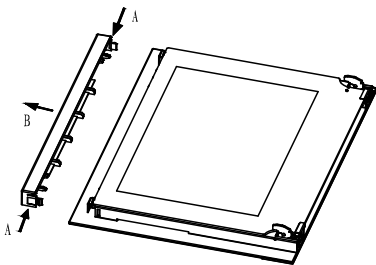

Fig.1

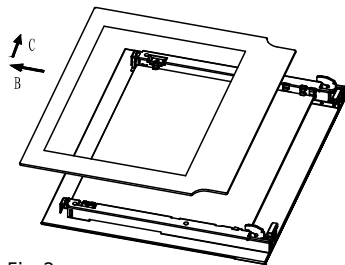

Fig.2

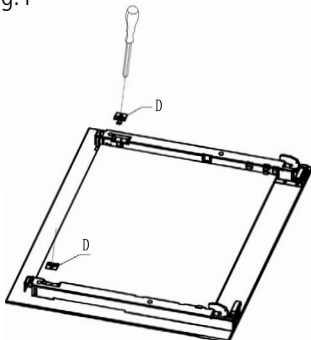

Fig.3

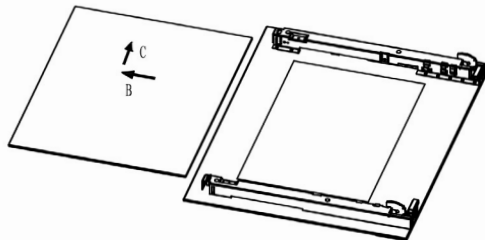

Fig.4

# NOTES

---



Caple Service  
Fourth Way  
Avonmouth  
Bristol  
BS11 8DW

T: 0117 938 7420  
E: [service@caple.co.uk](mailto:service@caple.co.uk)  
[www.caple.co.uk](http://www.caple.co.uk)