



Sense Microwave
Instruction Manual

CM108BG



Contact Caple on 0117 938 7420 for spare parts or www.caple.co.uk

CONTENTS

Warnings	3
Environmental Protection	10
Warranty	10
Installation	11
Dimensions	12
Electronic Connection	13
Control Panel	14
Display / Accessories	15
Operation / Functions	16
Auto Cooking	18
Defrost Time Table	21
Sound	22
Demo Mode	23
Care and Maintenance	24
Removing the Oven Door	25
Troubleshooting	26
Technical Data	26
Caple Contact Details	27

SAFETY INSTRUCTIONS

GENERAL WARNINGS:

Read carefully all the instructions contained in this manual. It provides you with important information regarding the safe installation, use and maintenance of the appliance as well as useful advice for getting the best out of your microwave oven. Keep this booklet in a safe place for future reference. After removing the packing, check that the appliance is not damaged in any way.

Be careful not to leave the packing materials (plastic sheeting, expanded polystyrene etc.) where children can get at them, as they can be dangerous.

IMPORTANT: Do not use the microwave door handle to move the appliance, such as to remove it from the packaging.

ATTENTION:

The microwave oven is an appliance which, for its nature, becomes hot during use, especially the glass door.

It is therefore a good rule that children do not approach the microwave oven when it is functioning.

- This appliance is intended to be used in household and similar applications such as:
 - Staff kitchen areas in shops, offices and other working environments.
 - Farm Houses.
 - By clients in hotels, motels and other residential type environments.
 - Bed and breakfast type environments.

The electrical system of this appliance may be used safely only when it is correctly connected to an efficient earthing system in compliance with the safety standards currently in effect.

The manufacturer will not be held liable for any damages that might arise out of incorrect or improper use of the appliance.

The following items are potentially dangerous, and therefore, appropriate measures must be taken to prevent children and the disabled from coming into contact with them:

- Controls and the appliance in general
- Packaging (bags, polystyrene, nails, etc.)
- The appliance when no longer in use (potentially dangerous parts must be made safe).

WARNING:

Accessible parts will become hot when in use. To avoid burns and scalds children should be kept away.

During use the appliance becomes hot, care should be taken to avoid touching heating elements inside the oven.

- If the door or door seals are damaged, the microwave must not be operated until it has been repaired by a Caple approved engineer.
- It is hazardous for anyone other than a competent person to carry out any service or repair operation that involves the removal of a cover which gives protection against exposure to microwave energy.
- Liquids and other foods must not be heated in sealed containers since they are liable to explode.
- Only use utensils that are suitable for use in microwave ovens.
- When heating food in plastic or paper containers, keep an eye on the microwave due to the possibility of ignition.
- The microwave oven is intended for heating food and beverages. Drying of food or clothing and heating of warming pads, slippers, sponges, damp cloth and similar may lead to risk of injury, ignition or fire.
- The microwave should be cleaned regularly and any food deposits removed.

- Failure to maintain the microwave oven in a clean condition could lead to deterioration of the surface that could adversely affect the life of the appliance and possibly result in a hazardous situation.

WARNING :

- To reduce the risk of burns, electric shock, fire, injury to persons or exposure to excessive microwave energy:
- Make sure that all the packing materials are removed from the inside of the door.
- This microwave oven must be placed on a flat, stable surface to hold its weight and the heaviest food likely to be cooked in the oven.
- Do not place the microwave oven where heat, moisture, or high humidity are generated, or near combustible materials.
- Do not operate the microwave oven when empty.
- Do not operate this appliance if it has a damaged cord or plug, if it is not working properly or if it has been damaged or dropped. If the supply cord is damaged, it must be replaced by Caple or an approved engineer in order to avoid a hazard.
- Microwave heating of liquids can result in delayed eruptive boiling, therefore care has to be taken when handling the container.
- Do not fry food in the microwave oven. Hot oil can damage oven parts and utensils and even result in skin burns.

- Eggs in their shell and whole hard-boiled eggs should not be heated in microwave ovens since they may explode even after microwave heating has ended.
- Pierce foods with heavy skins such as potatoes, whole squashes, apples and chestnuts before cooking.
- The contents of feeding bottles and baby jars should be stirred or shaken and the temperature should be checked before serving in order to avoid burns.
- Utensils should be checked to ensure that they are suitable for use in microwave oven.
- This appliance is not intended for use by persons (including children) with reduced physical, sensory or mental capabilities, or lack of experience and knowledge, unless they have been given supervision or instruction concerning use of the appliance by a person responsible for their safety.
- Children should be supervised to ensure that they do not play with the appliance.
- When heating food in plastic or paper containers, check the oven frequently for the possibility of ignition.
- Remove wire ties from paper or plastic bags before placing bag in oven.
- If smoke is observed. Switch off or unplug the appliance and keep the door closed in order to stifle any flames.
- Do not leave paper products, cooking utensils or food in the cavity when not in use.

- WARNING: Check the microwave oven for any damage, such as misaligned or bent door, damaged door seals and sealing surface, broken or loose door hinges and latches and dents inside the cavity or on the door. If there is any damage, do not operate the microwave oven and contact Caple service immediately.
- WARNING: Liquid or other food must not be heated in sealed containers since they are liable to explode.
- WARNING: It is hazardous for anyone other a trained person to carry out any service or repair operation which involves the removal of any cover which gives protection against exposure to microwave energy.
- Accessible parts may become hot during use.

WARNING:

The appliance and its accessible parts become hot during use.

Care should be taken to avoid touching heating elements.

Children less than 8 years of age shall be kept away unless continuously supervised.

This appliance can be used by children aged from 8 years and above and persons with reduced physical, sensory or mental capabilities or lack of experience and knowledge if they have been given supervision or instruction concerning use of the appliance in a safe way and understand the hazards involved. Children shall not play with the appliance. Cleaning and user maintenance shall not be made by children without supervision.

During use the appliance becomes hot. Care should be taken to avoid touching heating elements inside the oven.

Young children should be kept away.

ATTENTION:

- Before use, remove all plastic films protecting some parts of the appliance (fascia - panel, parts in stainless steel, etc.).
- Do not use the appliance to heat a room.
- When the appliance is not in use, we recommend you turn it off, isolate it from the electrical supply.



ENVIRONMENTAL PROTECTION

Waste electrical products should not be disposed of with household waste. Please recycle where facilities exist. Check with your Local Authority or retailer for recycling advice.

This appliance is marked according to the European directive on Waste Electrical and Electronic Equipment (WEEE).

By ensuring this product is disposed of correctly, you will help prevent potential negative consequences for the environment and human health, which could otherwise be caused by inappropriate waste handling of this product. The symbol on the product indicates that this product may not be treated as household waste. Instead it shall be handed over to the applicable collection point for the recycling of electrical and electronic equipment. Disposal must be carried out in accordance with local environmental regulations for waste disposal.

For more detailed information about treatment, recovery and recycling of this product, please contact your local council, your household waste disposal service or the retailer where you purchased the product.

CE DECLARATIONS OF CONFORMITY



This appliance has been designed, constructed and marketed in compliance with safety requirements in force. This appliance has been manufactured to the strictest standards and complies with all applicable legislation.

UKCA DECLARATIONS OF CONFORMITY



This appliance has been manufactured to the strictest standards and complies with all applicable legislation.

WARRANTY

Your new appliance is covered by warranty. The warranty card is enclosed - if it is missing, you must provide the following information to your retailer in order to receive a replacement: date of purchase, model and serial number (placed on the inside of the appliance storage drawer). Registration can also be completed online by visiting www.caple.co.uk.

Ensure you keep your warranty card safe, you may need to show it to Caple Service together with proof of purchase. If you fail to show your warranty card you will incur all repair charges.

Spare parts are only available from Caple Service and spare parts authorised centres.

INSTALLATION

IMPORTANT:

Isolate your microwave oven from the electrical supply before performing installation or maintenance.

Installation should be carried out according to the instructions by a professionally qualified person only.

The manufacturer declines all responsibility for any damage to persons, animals or materials due to incorrect installation.

FITTING THE APPLIANCE:

Fit the appliance into its surround (beneath a worktop or above another appliance in a tall housing) by inserting screws into the 4 holes (A - fig.3) that can be seen in the frame of the oven when the door is open.

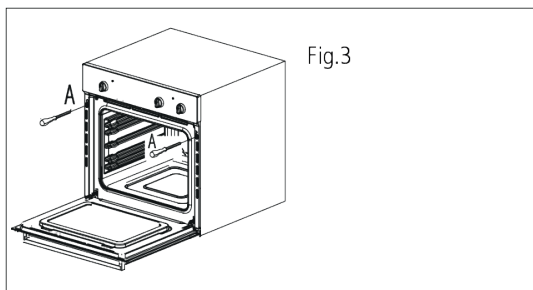

For the most efficient air circulation, the microwave oven should be fitted according to the dimensions shown in fig.1.

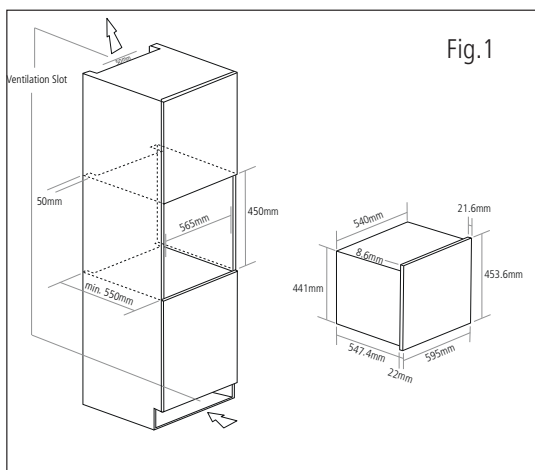

The rear panel of the cabinet must be removed so that air can circulate freely. The panel to which the microwave oven is fitted should have a gap of at least 50mm at the rear for ventilation (fig.4 & fig.5).

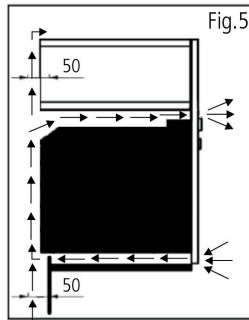
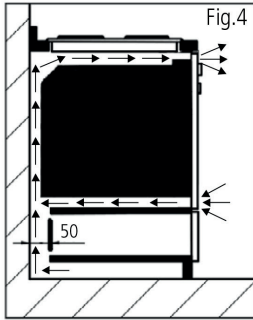

See below for full dimensional drawings of your microwave oven to help with installation.

For a built-in oven microwave to work well the cabinet must be of the right type. The panels of the adjoining furniture should be heat resistant. Particularly when the adjoining furniture is made of veneered wood, the adhesives should be able to withstand a temperature of 120°C. Plastic materials or adhesive which cannot withstand this temperature may become deformed or unstuck.

To comply with safety regulations, once the appliance has been fitted it should not be possible to make contact with the electrical parts.

All parts which offer protection should be fixed in such a way that they cannot be removed without the use of a tool.

MICROWAVE OVEN DIMENSIONS

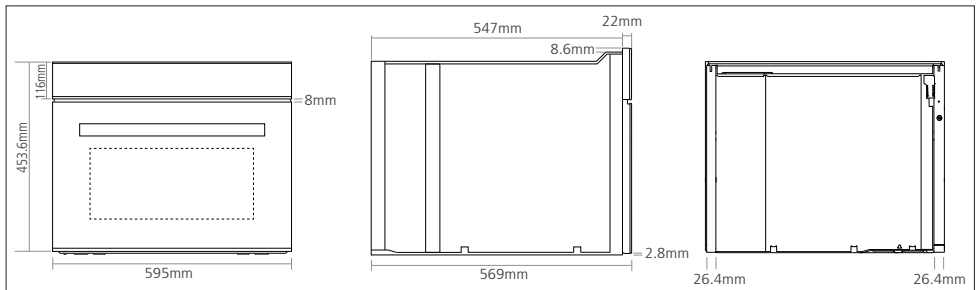

ELECTRICAL CONNECTION

WARNING:

This appliance must be earthed.

- › Check that the power rating of the mains supply is suitable for the maximum power of the appliance as indicated on the rating label.
- › The fuse rating for this appliance is 10amp.

The appliance is supplied with a mains lead it should be "Hard wired" as follows:

- › The "yellow/green" earth wire, which must be connected to a terminal, and has to be about 10mm longer than the other wire.
- › The neutral wire has to be connected to the terminal marked with a letter N.
- › The Live wire should only be connected to the terminal marked L.
- › Mains connection can also be made by fitting a double pole switch with a minimum gap between the contacts of 3mm, proportionate to the load and complying with the regulations in force.

THE YELLOW/GREEN EARTH WIRE SHOULD NOT BE CONTROLLED BY THE SWITCH.

When a double pole switch is used for mains supply connection it should be easily accessed, once the appliance is in position.

IMPORTANT:

The mains supply cable should be positioned so that it is never subjected to temperatures which are more than 50°C above ambient temperature.

The electrical safety of the appliance can only be guaranteed when it has been correctly connected to a properly earthed mains electrical supply, as laid down in the current regulations for electrical safety.

The manufacturer cannot be held responsible for any damage to persons or objects due to lack of an earth connection.

The ovens are designed to operate with a mono-phase alternating current of 220-240V, 50Hz.

IMPORTANT:

Before the installation of the appliance, check the specifications on the rating label.

CONTROL PANEL

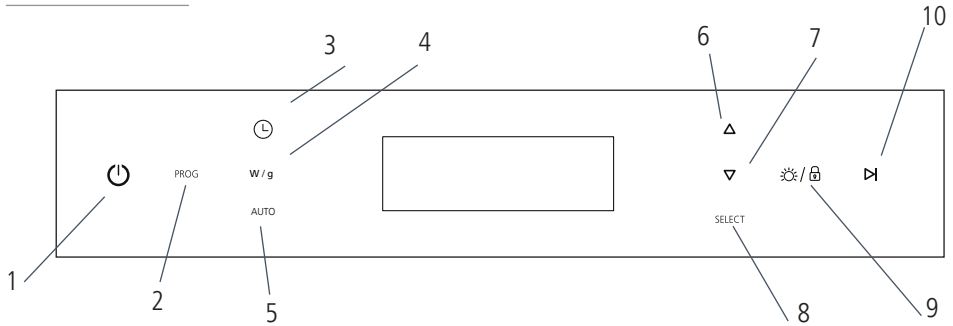

- | | |
|-----------------------------------|-----------------------|
| 1. Power | 6. Up |
| 2. Programme | 7. Down |
| 3. Timer | 8. Select |
| 4. Power (watts) / Weight (grams) | 9. Light / Child lock |
| 5. Auto cooking | 10. Start / Pause |

DISPLAY

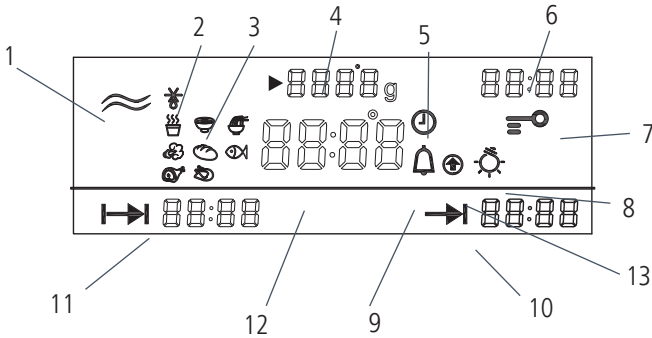

- | | | |
|---------------------------|---------------|-----------------------|
| 1. Microwave | 6. Time | 11. Duration time |
| 2. Defrost | 7. Child lock | 12. Time Display |
| 3. Auto cooking | 8. Light | 13. Heating Indicator |
| 4. Power / Weight (grams) | 9. Alarm | |
| 5. Timer | 10. End time | |

NOTE:

The Heating indicator will turn on to show the microwave is in use and heating the contents inside. When the selected microwave programme is finished this indicator will turn off.

ACCESSORIES

GLASS BASE PLATE (FIG. 1)

When microwaving only, foods and beverages can be placed on the Glass base plate.

The Glass base plate protects the bottom of the microwave cavity from any scratches, marks or spillages.

It can also be easily removed for cleaning by either hand or in the dishwasher.









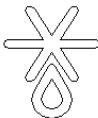



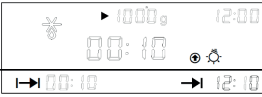

Fig. 1

OPERATION / FUNCTIONS

Press the  button to turn the oven on. When turned on, the display will light up and the time of day will be shown.



PROGRAMME / FUNCTION:

	<p>Microwave - Default power P100 (power range P10-P100). To adjust the power, press  /  until the correct power is reached followed by SELECT.</p> <p>Default time is 30 seconds. To adjust the time press the  button followed by the  /  and SELECT to confirm. The time will increase in 30 seconds increments (Max 60mins).</p> <p>Note: The timer when using the microwave function will display 'minutes : seconds', in defrost it will show 'hours : minutes'.</p> <p>Finally press  to start the programme.</p>	
	<p>Defrost -Default weight 1000g (weight range 100-2000g).</p> <p>To adjust the weight press the °C/W/g button followed by the  /  and SELECT to confirm.</p> <p>Finally press  to start the programme. The default time will be adjusted according to the set weight (See the 'Defrost time table' for more info).</p>	

WARNING:





All programmes which include the Microwave function do not require pre-heating, and must only be used with food inside the oven.

LIGHT FUNCTION:

Press the  /  button once to turn the internal microwave oven lights on & off. The lights will automatically turn off after 3 minutes of no operation.

When the light is activated the  symbol will be shown on the display.

CHILD LOCK:

Hold the  /  button for 2-3 seconds to activate the child lock. To deactivate, press and hold  /  the button again for 2-3 seconds.

When the Child lock is activated, the  symbol will be shown on the display.

ALARM SETTING:

To set the Alarm/minute minder, press the  button until the  symbol starts to flash.

Use  /  to adjust the time, and then press **SELECT** to confirm. If you want to cancel the alarm, set the alarm time back to '0.00' and press **SELECT** to confirm.



When the time is up, the alarm will sound for 90 seconds, and the  symbol will begin to flash. To stop the alarm, press any button.

SETTING THE TIME:

To set the time, turn the oven on, and then press and hold the  button for 3 seconds until the time begins to flash. Adjust the time using the  /  and then press **SELECT** to confirm.

When the oven is first turned on or restarts, the time must be set before using the oven.

DURATION COOKING(0-10HRS):

Once a function and temperature have been selected, press the  button and the Duration time will start to flash. Press  /  to adjust the time, and then **SELECT** to confirm. Once the time is up, the alarm will sound and the oven will switch off.

Press any of the buttons to turn off the alarm  / , **SELECT**, and .

To cancel Duration cooking set the cooking time to '0:00' and confirm.

END COOKING TIME:



Once the Duration cooking time has been set, press  twice and the End cooking time should start to flash. Adjust the time to the time you wish cooking to stop and press **SELECT** to confirm.

Your oven will then work out when to turn on, so that it cooks for the required duration time, and finishes at the required end time. E.g. Duration time set at 30 minutes, and the end time set to 18.15, the oven will automatically turn on at 17.45 and cook for 30 minutes on the set function and temperature (start time = End time - duration time).







STANDBY MODE:



To save energy, the display will automatically turn off after a few minutes of no use.

AUTO COOKING

SYMBOL	DESCRIPTION	DISPLAY
	<p>Milk (Auto programme)</p> <p>Press the Auto programme button until the Milk symbol is displayed.</p> <p>Press the °C/W/g to enter the Weight selection.</p> <p>Use the Δ / ∇ to adjust the weight and press SELECT to confirm.</p> <p>The default time will be adjusted according to the weight selected.</p> <p>Finally press \blacktriangleright to start the programme.</p>	

AUTO COOKING FUNCTIONS

SYMBOL	DEFAULT WEIGHT	WEIGHT ALTERNATIVES	FUNCTION	DURATION
 Milk	250g	250	Microwave	2
		500	Microwave	4
 Soup	500g	500	Microwave	19
		800	Microwave	22
 Noodles	300g	300	Microwave	5
		600	Microwave	8
 Vegetables	200g	100	Microwave	2
		200	Microwave	4
		300	Microwave	5
		400	Microwave	6
		500	Microwave	7
		600	Microwave	8
 Bread	200g	100	Microwave	1
		200	Microwave	2
		300	Microwave	3
 Fish	500g	100	Microwave	3
		200	Microwave	5
		300	Microwave	6
		400	Microwave	7
		500	Microwave	8
		600	Microwave	9
		700	Microwave	10
		800	Microwave	11
		900	Microwave	12
		1000	Microwave	13

 Meat	500g	200	Microwave	7
		300	Microwave	8
		400	Microwave	10
		500	Microwave	12
		600	Microwave	14
		800	Microwave	16
		100	Microwave	19
 Chicken	1000g	200	Microwave	15
		400	Microwave	20
		600	Microwave	25
		800	Microwave	30
		1000	Microwave	32
		1200	Microwave	35
		1400	Microwave	40
		1600	Microwave	46
		1800	Microwave	52
		2000	Microwave	56

DEFROST TIME TABLE

The maximum weight for defrost is 2000g. The default defrost time will be adjusted according to different weight selected.

WEIGHT (GRAMS)	TIME (MINUTES)	WEIGHT (GRAMS)	TIME (MINUTES)
100	3	1100	22
200	5	1200	24
300	6	1300	26
400	8	1400	28
500	10	1500	30
600	12	1600	32
700	14	1700	34
800	16	1800	36
900	18	1900	38
1000	20	2000	40

SOUND

TO TURN OFF TOUCH CONTROL SOUND

To turn off the touch control sound on your appliance, simultaneously press  and **SELECT** for 3 secs. A beep will sound to signal the touch control sounds are Off.



NOTE:



Only the sound from pressing the touch controls will turn off. All other audio alerts will continue to work.

TO TURN ON TOUCH CONTROL SOUND

To turn on the touch control sound on your appliance, simultaneously press  and **SELECT** for 3 secs. A beep will sound to signal the touch control sounds are On.

DEMO MODE

TO TURN ON DEMO MODE:

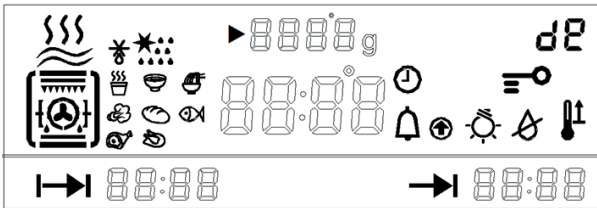

Press the  button to turn the oven on (in standby mode). Press and hold the  button for 5 seconds. The alarm will beep 3 times, and **dE** will appear in the top right of the display to confirm the oven has entered demo mode.



In demo mode, the normal operation of the cooling fan, circulation fan, and lighting work normally, however all heating elements and other functions are disabled.

If the oven is turned off, it will remain in Demo mode when the oven is turned back on.

TO TURN OFF DEMO MODE:

Press the  button to enter standby mode, then press and hold the  button for 5 seconds. The alarm will beep 3 times, and the **dE** will disappear from the display to confirm the system has exited Demo mode, and is ready for normal use.

CARE AND MAINTENANCE

IMPORTANT:

Unplug your oven before cleaning, or performing maintenance.

To extend the life of your microwave oven, it must be cleaned frequently, keeping in mind the following:

DO NOT USE STEAM EQUIPMENT TO CLEAN THE APPLIANCE:

To protect against the risk of electrical shock, do not immerse the unit, cord or plug in water or other liquid or sprinkle water to clean the appliance.

- › Don't clean the appliance when it still hot. The inside and external surface of the oven should preferably be cleaned by damp cloth when it is cooled down.
- › Wash all accessories in hot soapy water or in a dishwasher, wipe dry with a paper or cloth towel.
- › If you use your oven for an extended period of time, condensation may form. Dry it using a soft cloth.
- › There is a seal surrounding the oven opening which guarantees its perfect functioning. Check the condition of this seal on a regular basis. If necessary, clean it and avoid using abrasive products or objects to do so. Should it become damaged, please contact Caple Service. We recommend you avoid using the oven until it has been repaired.
- › Never line the oven bottom with aluminium foil, as the consequent accumulation of heat could compromise the cooking and even damage the enamel.
- › Clean the glass door using damp cloth and dry it with a soft cloth.
- › Do not use harsh abrasive cleaners or sharp metal scrapers to clean the oven door glass since they can scratch the surface, which may result in shattering of the glass.

REMOVING THE OVEN DOOR

To make it easier to clean the inside of your microwave, the oven door can be easily removed, by proceeding as follows (fig. 11):

- › Open the door completely and lift the 2 levers "B" (fig.11-1).
- › Now, shutting the door slightly, you can lift it out by pulling out the hooks "A" as shown in figure 11-2.

To reassemble the door:

- › With the door in a vertical position, insert the two hooks "A" into the slots.
- › Ensure that seat "D" is hooked perfectly onto the edge of the slot (move the oven door backwards and forward slightly).
- › Keep the oven door open fully, unhook the 2 levers "B" downwards and then shut the door again.

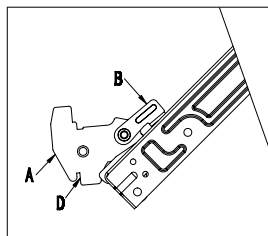

Fig.11-1

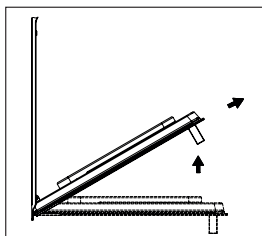

Fig.11-2

TROUBLESHOOTING

The microwave does not operate	<ul style="list-style-type: none"> › Check it is switched on at the mains › There has been a power cut › The time is not set
The control panel is not working	Check to see if the child lock is on. If so, hold the lock key to turn it off.
The interior lamp does not illuminate	Contact Caple service.
E2 error code appears on the screen	Interior sensor error. Contact Caple service.

TECHNICAL DATA

	BUILT-IN MICROWAVE
Model	CM108
Rated voltage	220 - 240V ~
Rated frequency	50Hz
Rated Microwave Input Power	1500W
Microwave rated output power	1000W
Volume	40L

NOTES



Caple Service
Fourth Way
Avonmouth
Bristol
BS11 8DW

T: 0117 938 1900
E: service@caple.co.uk
www.caple.co.uk

