



Built in Freezer
Instruction Manual

RIF892



Contact Caple on 0117 938 7420 for spare parts or www.caple.co.uk

CONTENTS

Warnings	3
Environmental Protection	11
Technical Fiche	11
Electrical Connection	12
Product Overview	13
Using the Appliance	14
Ventilation Requirements	16
Installation	17
Built-in Installation	18
Installing the Furniture Door	21
Reversing the Furniture Door	24
Food Storage	27
Cleaning and Maintenance	32
Transport and Repositioning	34
Troubleshooting	35
Energy Saving Tips	38
Caple Contact Details	40

SAFETY INSTRUCTIONS

Read these instructions carefully and completely before using your appliance. They provide you with important information regarding the safe installation, use and maintenance of the appliance as well as useful advice for getting the best out of your freezer. Keep this booklet in a safe place for future reference and pass on to any future owner.

- This appliance is produced in accordance with all applicable local and international standards and regulations.
- This appliance is intended to be used in household and similar applications such as:
 - › Staff kitchen areas in shops, offices and other working environments.
 - › Farm Houses.
 - › By clients in hotels, motels and other residential type environments.
 - › Bed and breakfast type environments.
- This appliance may only be used by persons (including children) with reduced physical, sensory or mental capabilities, or lack of experience and knowledge, if they are supervised whilst using it. They may only use it unsupervised if they have been shown how to use it in a safe manner. They must be able to recognise and understand the dangers of misuse.

SAFETY WITH CHILDREN:

- This appliance can be used by children aged from 8 years and above.
- Children less than 8 years of age should be kept away unless continuously supervised or they have been shown how to use it in a safe manner. Children must be able to understand and recognise the possible dangers caused by incorrect operation.
- Children should be supervised in the vicinity of the appliance.
- Never allow children to play with the appliance.
- Cleaning and user maintenance should not be carried out by children without supervision.
- Children aged from 3 to 8 years are allowed to load and unload refrigerating appliances.
- Materials used for packaging (nylon, staplers, Styrofoam etc) may cause harmful effects to children, they should be disposed of immediately.
- Children can injure themselves on an open door. Do not let children sit on the open door, lean against it or swing on it.

TECHNICAL SAFETY:

- Maintenance and repair work must be made only by authorised Caple service technicians. Installation and repair work that is carried out by unauthorised technicians may endanger you.

- While the appliance is under warranty, repairs should only be undertaken by a Caple authorised service technician. Otherwise the warranty will be invalidated.
- It is dangerous to alter or modify the specifications of the appliance in any way. The requirements for this appliance are stated on the rating label.
- Risk of injury due to electric shock. Any contact with live connections or tampering with the electrical or mechanical components of the appliance will endanger your safety and may lead to the appliance malfunctioning.
- To maintain the efficiency and safety of your appliance, we recommend you always use original spare parts and to call only our authorised Caple Service agents in case of need.
- Multi-socket adapters and extension leads should not be used to connect the appliance to the mains electricity supply.
- The electrical system of this appliance may be used safely only when it is correctly connected to an efficient earthing system in compliance with the safety standards currently in effect.
- Insert the plug into a socket with an efficient ground connection. If the socket has no ground contact or the plug does not match, we recommend you consult a qualified electrician for assistance.
- The appliance must be connected with a properly installed fused socket. The power supply (AC) and

voltage at the operating point must match with the details on the rating plate of the appliance.

- Consult a qualified electrician or service person if the Grounding instructions are not completely understood, or if you have doubts on whether the appliance is properly grounded.
- The incorrect grounding may cause breakdown and electric shock.
- We do not accept responsibility for any damages that occur due to ungrounded usage.
- If the socket does not match the refrigerator plug, it must be replaced by the manufacturer, a service agent or similarly qualified persons in order to avoid a hazard.
- A specially grounded plug has been connected to the power cable of your refrigerator. This plug should be used with a specially grounded socket of 13 amperes. If there is no such socket in your house, please have one installed by an authorised electrician.

INSTALLATION WARNINGS:

- Prior to installation, ensure that the local distribution conditions (electricity voltage and frequency) and the requirements of the appliance are compatible.
- During installation the appliance must be completely disconnected from the mains electricity supply.
- Do not operate the appliance before it is fully installed.

- The appliance must be installed by an authorised technician.
- Your appliance must be at least 10cm away from gas hobs, gas ovens and heater cores.
- If your freezer is placed next to a deep freezer, there must be at least 10cm between them to prevent humidity forming on the outer surface.
- Caple is not responsible for any damage that may be caused by defective placement and installation by unauthorised persons.
- When unpacking the appliance, make sure that it is not damaged during transportation.
- Check the appliance for any damage.
- In the case of any defect; do not use the appliance and contact your retailer or Caple Service immediately.
- Ensure that the supply cord is not wedged, trapped or damaged during the installation. If the supply cord is damaged, it must be replaced by a Caple service technician or similarly qualified persons in order to prevent a hazard.
- Never touch the power cord/plug with wet hands. This may cause a short circuit or electric shock.
- The plug must be accessible after installation.
- Do not locate multiple portable socket-outlets or portable power supplies at the rear of the appliance.
- Protect your appliance against atmospheric effects. Do not expose it to effects such as sun, rain, snow etc.

DURING USE:

- Do not store explosive substances such as aerosol cans with a flammable propellant in this appliance.
- Place drinks with high alcohol content vertically in the fridge compartment and make sure their tops are tightly closed.
- If you know you will not be using the appliance for a while switch it off from the main supply and unplug it.
- Keep ventilation openings, in the appliance enclosure or in the built-in structure, clear of obstruction.
- Do not place your appliance on a carpeted surface as this will prevent adequate ventilation.
- When the appliance is not in use, we recommend you turn it off, and isolate it from the electrical supply.
- This appliance must be used in the vertical position on a flat surface.
- Do not use electrical appliances inside the food storage compartments of the appliance, unless they are of the type recommended by the manufacturer.
- The manufacturer will not be held liable for any damages that might arise out of incorrect or improper use of the appliance.
- Do not touch frozen goods with wet hands. Your hands may freeze to the frozen food.
- Do not eat ice-cream or ice cubes immediately after they are removed from the freezer compartment.

Frozen food can cause frost burn to the lips and tongue.

- Do not re-freeze partially or fully thawed food. This may cause health issues such as food poisoning. Defrosted food may only be re-frozen after it has been cooked.
- Do not place glass bottles or cans containing carbonated drinks in the freezer compartment as they will burst when the contents freezes.
- If using the appliance to quickly cool drinks, do not leave bottles inside the freezer compartment for more than 1 hour, otherwise they could burst.

CLEANING AND MAINTENANCE:

- Clean the appliance thoroughly before use.
- Always switch off the appliance from the mains isolating the electrical supply before any cleaning or maintenance.
- Do not use mechanical devices or other means to accelerate the defrosting process, other than those recommended by the manufacturer.

TRANSPORT:

- Always transport the appliance in its original packaging and in an upright position. Never tilt the appliance backwards by more than 45 degrees.

- This model uses R600a as a refrigerant, therefore you should take care during transportation and installation to prevent the cooler elements from being damaged. R600a is an environmentally friendly and natural gas, but it is explosive. In the event of a leak due to damage of the cooler elements, move your freezer away from open flames or heat sources and ventilate the room where the appliance is located for a few minutes.
- Never use the door handles for lifting.
- The appliance is heavy and could cause injury, it must be transported by two people.

DISPOSAL OF OLD APPLIANCE:

- Old fridges and freezers contain isolation material and refrigerant with CFC. Therefore, take care not to harm environment when you are discarding your old fridges.
- If your old fridge or freezer has a lock, break or remove the lock before discarding it, because children may get trapped inside it and may cause an accident.
- Be careful to avoid damaging the pipework before disposal, e.g. by puncturing coolant channels, bending pipework, scratching the surface coating.



Symbol ISO 7010 W021

Warning; Risk of fire / flammable materials



ENVIRONMENTAL PROTECTION

Waste electrical products should not be disposed of with household waste. Please recycle where facilities exist. Check with your Local Authority or retailer for recycling advice. This appliance is marked according to the European Directive on Waste Electrical and Electronic Equipment (WEEE).

By ensuring this product is disposed of correctly, you will help prevent potential negative consequences for the environment and human health, which could otherwise be caused by inappropriate waste handling of this product. The symbol on the product indicates that this product may not be treated as household waste. Instead it shall be handed over to the applicable collection point for the recycling of electrical and electronic equipment. Disposal must be carried out in accordance with local environmental regulations for waste disposal.

For more detailed information about treatment, recovery and recycling of this product, please contact your local council, your household waste disposal service or the retailer where you purchased the product.

CE DECLARATIONS OF CONFORMITY **CE**

This appliance has been manufactured to the strictest standards and complies with all applicable legislation, Low Voltage Directive (LVD) and Electromagnetic Compatibility (EMC).

UKCA DECLARATIONS OF CONFORMITY **UK CA**

This appliance has been manufactured to the strictest standards and complies with all applicable legislation.

TECHNICAL FICHE

This appliance conforms to all current and applicable energy regulations. To view the Technical Fiche that supports the energy labelling data, please visit the product page on our website www.caple.co.uk

WARRANTY

Your new appliance is covered by warranty. The warranty card is enclosed - if it is missing, you must provide the following information to your retailer in order to receive a replacement: date of purchase, model and serial number (placed on the inside of the appliance storage drawer). Registration can also be completed online by visiting www.caple.co.uk.

Ensure you keep your warranty card safe, you may need to show it to Caple Service together with proof of purchase.

If you fail to show your warranty card you will incur all repair charges.

Spare parts are only available from Caple Service and spare parts authorised centres.

ELECTRICAL CONNECTION

For your safety please read the following information.

WARNING:

This appliance must be earthed.



RISK OF ELECTRIC SHOCK

This appliance operates from 220-240 volts and should be protected by a 13 amp fuse in the plug.

The appliance is supplied with a standard 13 amp 3-pin mains plug fitted with a 13-amp fuse. Should the fuse require replacement, it must be replaced with a fuse rated at 13 amp and approved to BS1362.

If the mains plug which is fitted is unsuitable for the socket outlet in your home or is removed for any other reason, please follow the instructions below on how to wire a 13 amp 3 pin plug.

HOW TO WIRE A 13 AMP PLUG.

IMPORTANT:

The wires in the mains lead on this appliance are coloured in accordance with the following code:

Green and Yellow - Earth

Blue – Neutral

Brown – Live

As the colours may not correspond with the markings identifying the terminals in your plug proceed as follows.

The green and yellow wire must be connected to the terminal in the plug which is marked with the letter E or with the earth symbol \perp or coloured green and yellow.

The blue wire must be connected to the terminal marked N.

The brown wire must be connected to the terminal marked L.

You must make sure the lead is firmly secured under the cord clamp.

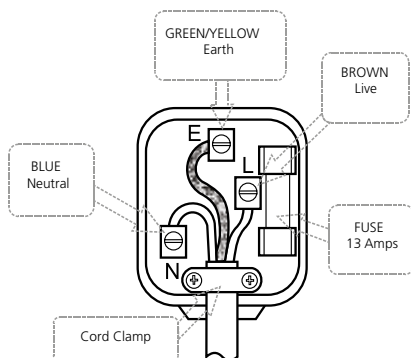

PRODUCT OVERVIEW

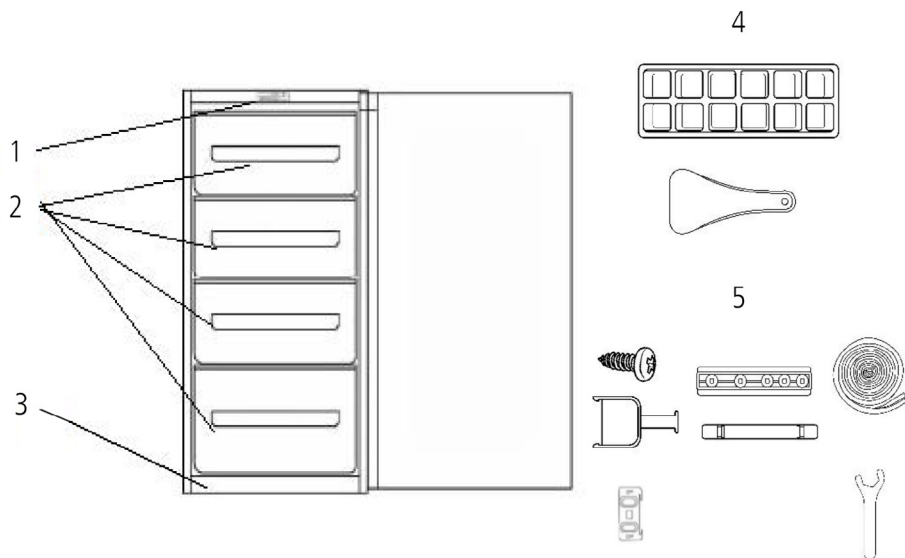

1. Thermostat
2. Drawers
3. Feet (adjustable feet at the front)
4. 1 x Ice Cube Tray, 1 x Ice Scraper
5. Installation Accessories

USING THE APPLIANCE

- › Before using your freezer, wipe all parts with a solution of warm water and a teaspoon of sodium bicarbonate. Then, rinse with clean water and dry. Return all parts to the freezer after cleaning.
- › Remove all transport tapes and foam protection pieces. Clean the interior with a cloth dampened in lukewarm soap and water. Rinse with clean water and dry.
- › Your freezer may have an odour when it is operated for the first time. This is normal and the odour will fade when your freezer starts to cool.
- › When the appliance has been positioned, adjust the feet to ensure the unit is stable. This is essential to ensure quiet running and proper door opening/closing.



WARNING

Connect to the electrical socket but do not switch the power to the freezer on for at least 3 hours. The coolant within the product needs time to settle after it has been transported and put into position, failure to do this will affect the cooling performance of your appliance.

- › Once the appliance has settled, locate the thermostat dial on the product, set to “5” and switch the power on. The compressor will begin to work. Close the door.
- › We recommend that the door is not opened for a minimum of 4 hours to allow the appliance to reach the standard operating temperature.
- › You may hear faint gurgling or bubbling sounds when the refrigerant is pumped to the cooling system and through the coils or tubing at the rear of the appliance. When the compressor is in operation you may hear a slight whirring sound. The thermostat controls the operation of the compressor, and you may hear a slight click as it cycles in and out, this is normal.

TEMPERATURE CONTROL DIAL:

The temperature in the appliance is controlled by the temperature control dial or thermostat located inside the freezer. Rotate the control dial left or right to regulate the temperature inside the freezer.

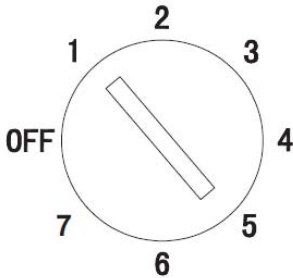

NOTE: 1 is the warmest setting and 7 is the coldest setting.

Depending on the ambient temperature of the room the appliance is situated in, you may need to adjust the temperature control dial; in a room with a high ambient temperature, the temperature control dial may need to be adjusted to a colder setting (moved towards setting 6) or in a room with a low ambient temperature the temperature control dial may need to be adjusted to a warmer setting (moved towards settings 5 or 4).

Setting 7 should be used as a rapid cool/freeze setting and should only be set 2 hours before a large amount of food is placed in the freezer. The temperature control should be put back to setting 5 after the food has been placed in the freezer, if this is not done the temperature in the freezer compartment could fall below 0°C as the compressor will run continuously.

Once the temperature control has been set, close the door and plug in the appliance. We recommend that the door is not opened for a minimum of 4 hours to allow the appliance to reach the standard operating temperature.

NOTE:

The standard operating temperature should be between -18°C and -25°C.

The temperature of freshly stored food and how often the door is opened affects the temperature in the freezer compartment. If required, change the temperature setting.

VENTILATION REQUIREMENTS

The main consideration when installing a refrigeration product into a cabinet is ventilation. The heat removed from the appliance needs to be dissipated into the room. Failure to correctly ventilate the product can result in increased running costs and premature failure. It will also invalidate the guarantee provided with the appliance.

An air intake in the plinth is required to allow for the correct air flow (recommended 540mm x 50mm). If preferred a decorative stainless steel plinth grille is available, product code: GRILL/ SENSE600.

This can be purchased from your retailer or www.caple.co.uk.

To ensure the correct operation of the appliance it is important the top of the housing is not blocked off. The top of the cabinet needs to be vented into the room, the recommended minimum size of the vent opening is 540 x 50mm.

There should also be space at the rear of the cabinet to allow the cool air to be drawn over the condenser. This should also be at least 540mm x 50mm. The more air available to circulate the product, the more efficiently it will operate.

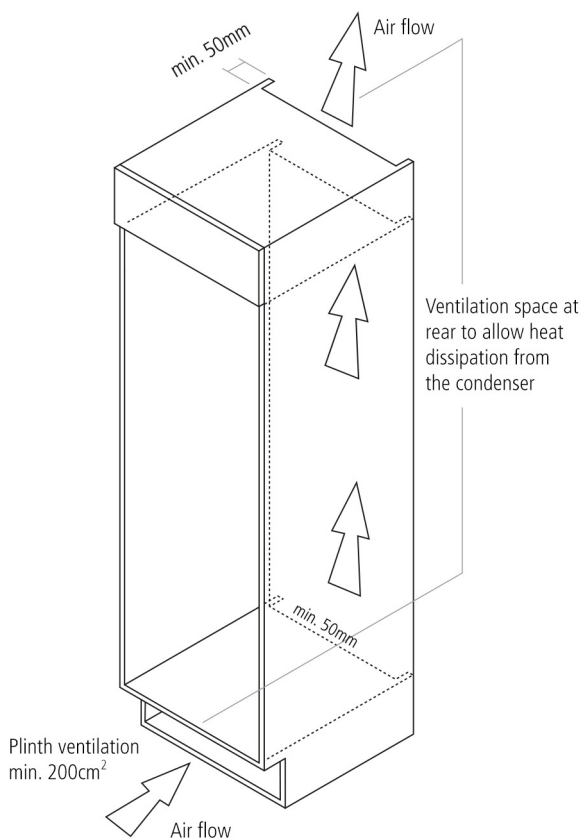

INSTALLATION

- › This appliance is to be installed as a built-in unit only. The clearances shown in the ventilation diagram must be followed.
- › Avoid damaging the product during installation, positioning of the appliance requires two people in order to avoid injuries or damage to the appliance.
- › Your appliance should not be located in direct sunlight or exposed to continuous heat or extremes of temperature (e.g. next to a radiator or boiler). If this is not feasible, then you should install an insulation plate between the appliance and the adjacent heat source.
- › You should check whether there is an electrical socket available, which will be accessible after your appliance is installed.
- › Place the appliance flatly and firmly on a solid base.
- › Be sure to leave enough space for the opening of the door, to avoid damage to the appliance or personal injury.

The accessories that are required for installation are detailed below:

12 x Torx Screws



2 x Door Guide

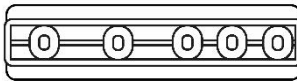

1 x Joint Cover

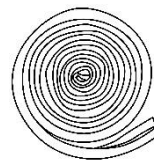

2 x Foot Blanking Covers

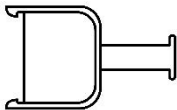

2 x Door Guide Cover



2 x Door Guide Holder
(pre-assembled on the door)



BUILT IN INSTALLATION

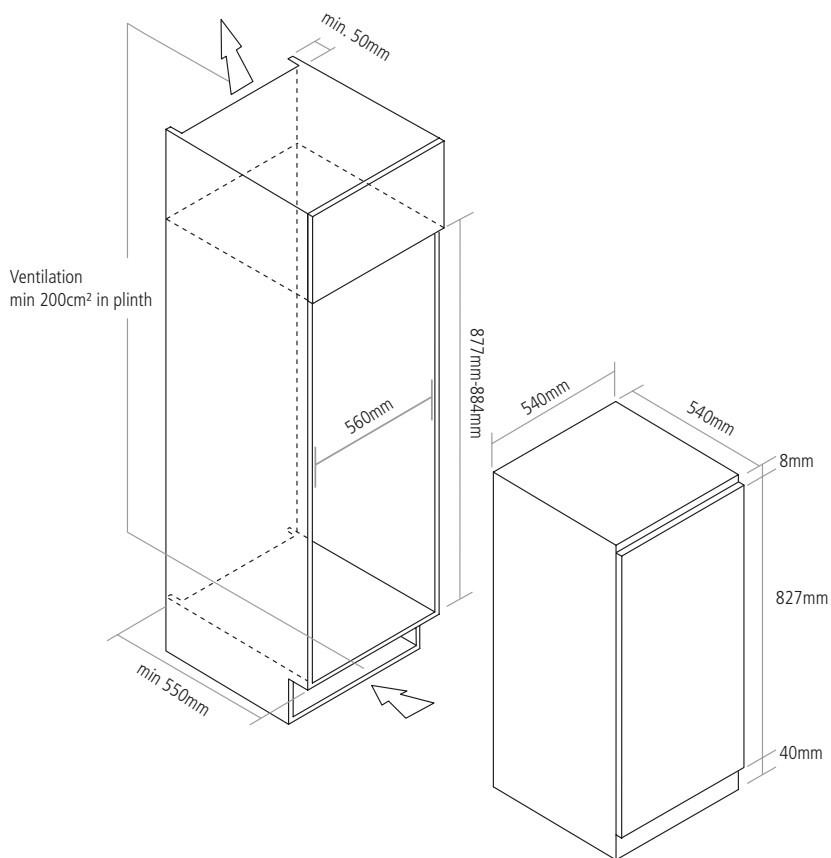

NOTE:

The wooden cabinet the appliance is to be housed in must not be enclosed. The back wooden panel of the cabinet must be removed completely. This is to allow sufficient air circulation to cool down the condenser unit for energy efficiency.

- › Carefully push the appliance into the housing, ensuring that the cabinet doors are able to fully close.
- › Rollout the joint cover and on the side of the appliance without the hinges press it between the appliance and the inside of the cabinet wall (start from the bottom and work upwards).

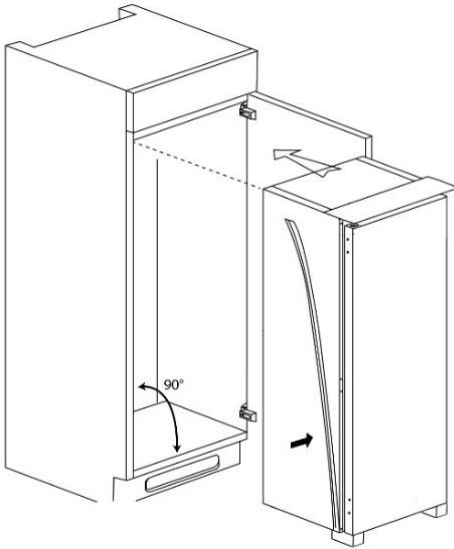

- › Open the door and push the side of the appliance without the hinges against the side of the cabinet wall. Fix the appliance in 2 places, 2 torx headed screws in the top plinth at the top of the appliance and 2 torx screws in the feet (1 in each foot) at the bottom of the appliance.

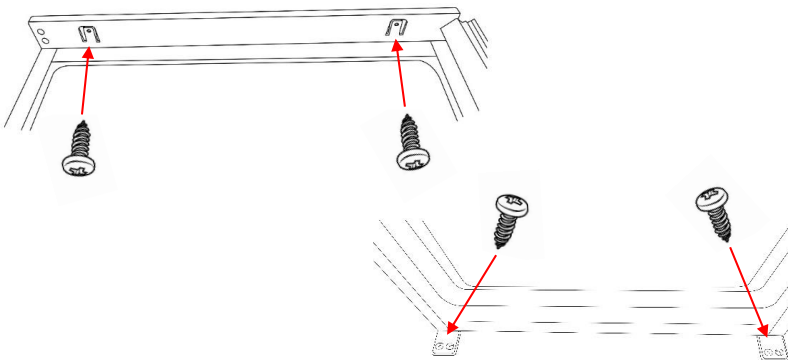

- › Apply the foot blanking covers by clipping them in to place on the feet at the bottom of the appliance. The plastic stem on the foot caps are there as a guide of what the distance between the product and the edge of the cabinet should be (approximately 42mm). Snap off the plastic stem after installation.

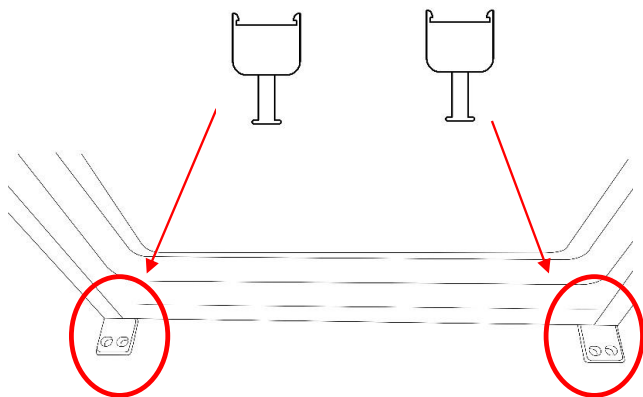

INSTALLING THE FURNITURE DOOR

Locate parts A and B (see the below) in the bag with the installation accessories:

A. Door guide

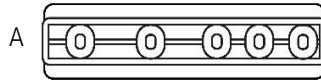

B. Door guide cover



- › Open the cabinet door and the freezer door, mark on the back of the cabinet door where the top of the freezer door reaches. Place the door guide (part A) on the back of the cabinet door, in the location shown below and mark the position of first hole and the last hole on the door guide. Fix the door guide into place with 2 torx headed screws.

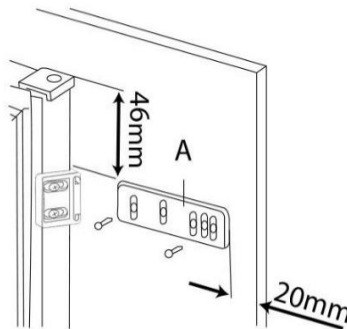

- › Clip the door guide cover (part B) on the door guide (part A) hiding the screws.

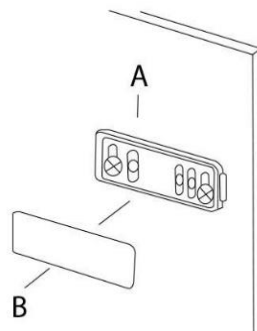

- › Open the appliance door and the cabinet door to 90°, remove the 2 screws from the door guide holder that is already prefixed to the door and place it on to the door guide (part A).
- › Push the appliance door and the cabinet door together, align the holes on the door guide holder and the holes on the edge of the door and fix into place with the 2 screws that were removed previously.

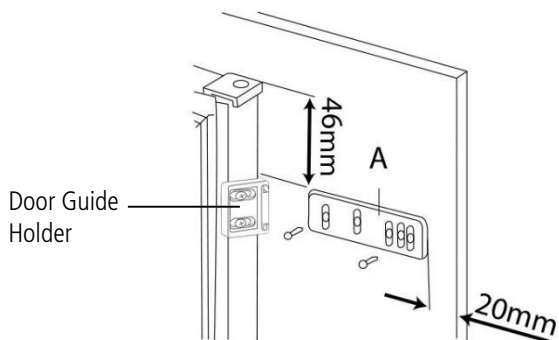

- › If any adjustment is needed use the clearance space in the screw slots of the door guide holder on to the door guide (part A).

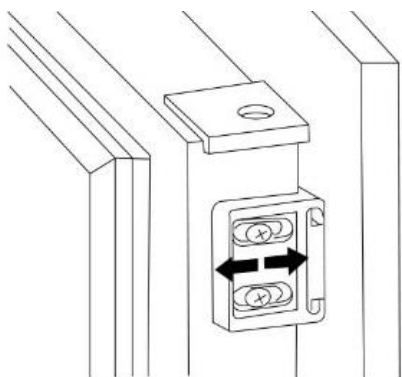

- › Check that the cabinet door closes correctly.

- › You will then have to repeat these steps at the bottom of the freezer door, please ensure you follow the below diagram when locating the door guide (part A) on the bottom of the freezer door.

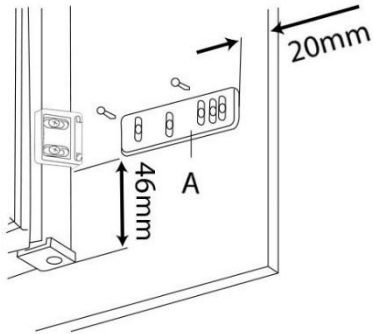

- › Once this is done, the installation should look like the below image:

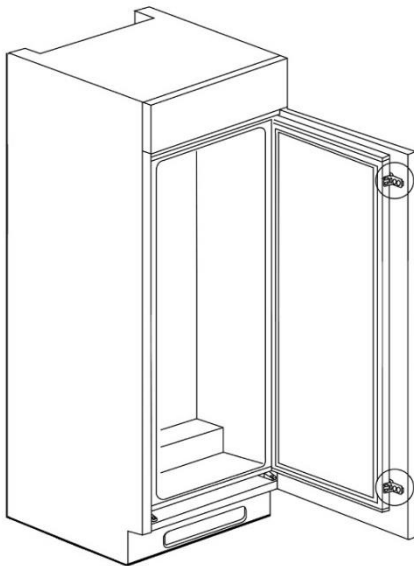

- › There are 2 hinge covers supplied for the lower and upper hinges. These can be clipped on if required.

REVERSING THE FURNITURE DOOR

To reverse the door you will need to tilt the appliance backward to access the lower hinge which holds the screws. Do not tilt the appliance more than 45° and do not lay the appliance flat on its side.

CAUTION:

For your own safety, a minimum of 2 people should lift or tilt this product.

Tools Required: Torx headed screwdriver, flat headed screwdriver and hexagonal spanner or a socket driver.

- › Unscrew the 2 screws from the upper hinge and remove the freezer door by carefully lifting it up and away from the appliance. Do not fix the hinge to the opposite side.

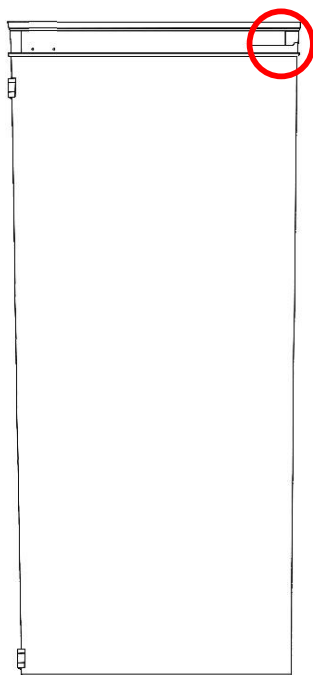

- › Unscrew the 2 screws from the lower hinge and remove the hinge.
DO NOT FIX THE HINGE TO THE OPPOSITE SIDE AT THIS STAGE.

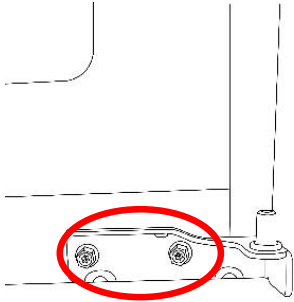

- › Remove all of the screw cap covers on the opposite side of the appliance from where the hinges have just been removed. Remove the hinge plugs on the top and bottom of the door and fix them to the opposite side.

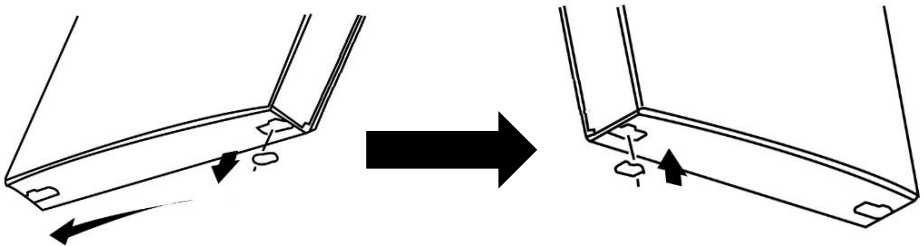

- › Flip over the lower hinge 180° and fix on to the opposite side at the bottom of the appliance. Place the door back on to the lower hinge.

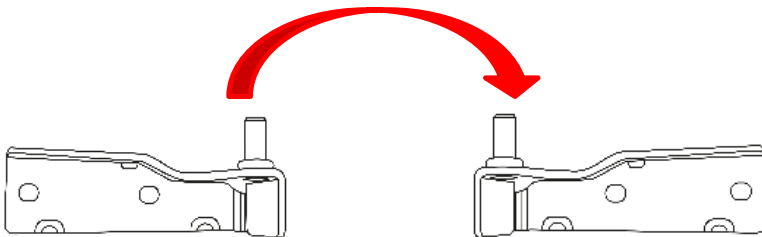

- › Move the top hinge from right to the left of the appliance and put the pin of the hinge into the top of the door and fix it in to place. Ensure the door is aligned horizontally and vertically so that the seals are closed on all sides before finally tightening the top hinge pin.
- › Remove the 2 door guide holders from side of the doors and fix them on to the opposite side.

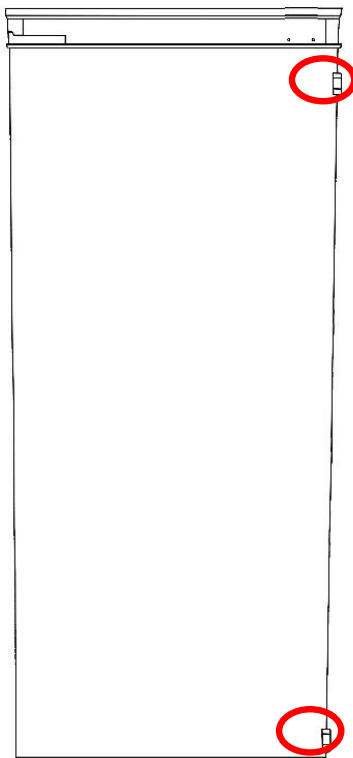

FOOD STORAGE

- › The freezer is used for storing frozen food, freezing fresh food, and making ice cubes.
- › To freeze fresh food, ensure that as much of the surface of the food as possible is in contact with the cooling surface.
- › Do not store fresh food next to frozen food as it can thaw the frozen food.
- › Before freezing fresh food, divide it into portions that can be consumed in one sitting.
- › Consume thawed frozen food within a short period of time after defrosting
- › Never place warm food in the freezer compartment as it will thaw the frozen food.
- › Always follow the manufacturer's instructions on food packaging when storing frozen food. If no information is provided food, should not be stored for more than 3 months from the date of purchase.
- › When purchasing frozen food, make sure that it has been stored under appropriate conditions and that the packaging is not damaged.
- › Frozen food should be transported in appropriate containers and placed in the freezer as soon as possible.
- › Do not purchase frozen food if the packaging shows signs of humidity band abnormal swelling.
- › It is probable that it has been stored at an unsuitable temperature and that the contents have deteriorated.
- › The storage life of frozen food depends on the room temperature, the thermostat setting, how often the door is opened, the type of food, and the length of time required to transport the product from the shop to your home. Always follow the instructions printed on the packaging and never exceed the maximum storage life indicated.
- › The maximum amount of fresh food (in kg) that can be frozen in 24 hours is indicated on the appliance label.

NOTE:

If you attempt to open the freezer door immediately after closing it, you will find that it will not open easily. This is normal. Once equilibrium has been reached, the door will open easily.

IMPORTANT NOTE:

- › Never refreeze thawed frozen food.
- › The taste of some spices found in cooked dishes (aniseed, watercress, vinegar, assorted spices, ginger, garlic, onion, mustard, thyme, black pepper, etc.) changes and they assume a strong taste when they are stored for a long period of time. Therefore, add small amounts of spices to food to be frozen, or the desired spice should be added after the food has thawed.
- › The storage time of food is dependent on the type of oil used. Suitable oils are margarine, calf fat, olive oil and butter. Unsuitable oils are peanut oil and pig fat.
- › Food in liquid form should be frozen in plastic cups and other food should be frozen in plastic or bags or containers. The table below is a quick guide to show you the most efficient way to store the major food groups in your freezer compartment.

MEAT & FISH	PREPARATION	MAXIMUM STORAGE TIME (MONTHS)
Steak	Wrap in foil	6 - 8
Lamb Meat	Wrap in foil	6 - 8
Veal roast	Wrap in foil	6 - 8
Veal cubes	In small pieces	6 - 8
Lamb cubes	In pieces	4 - 8
Minced meat	In packaging without using spices	1 - 3
Giblets (pieces)	In pieces	1 - 3
Bologna sausage/salami	Should be kept packaged even if it has a membrane	
Chicken and turkey	Wrap in foil	4 - 6
Goose and duck	Wrap in foil	4 - 6
Deer, rabbit, wild boar	In 2.5 kg portions or as fillets	6 - 8
Freshwater fish (Salmon, Carp, Crane, Catfish)	After cleaning the bowels and scales of the fish, wash and dry it. If necessary, remove the tail and head.	2
Lean fish (Bass, Turbot, Flounder)		4
Fatty fishes (Tuna, Mackarel, Bluefish, Anchovy)		2 - 4
Shellfish	Clean and in a bag	4 - 6
Caviar	In its packaging, or in an aluminium or plastic container	2 - 3

NOTE:

Thawed frozen meat should be cooked as fresh meat. If the meat is not cooked after defrosting, it must not be re-frozen.

VEGETABLES AND FRUITS	PREPARATION	MAXIMUM STORAGE TIME (MONTHS)
String beans and beans	Wash, cut into small pieces and boil in water	10 - 13
Beans	Hull, wash and boil in water	12
Cabbage	Clean and boil in water	6 - 8
Carrot	Clean, cut into slices and boil in water	12
Pepper	Cut the stem, cut into two pieces, remove the core and boil in water	8 - 10
Spinach	Wash and boil in water	6 - 9
Cauliflower	Remove the leaves, cut the heart into pieces and leave it in water with a little lemon juice for a while	10 - 12
Aubergine	Cut into pieces of 2cm after washing	10 - 12
Sweetcorn	Clean and pack with its stem or as sweetcorn	12
Apple and pear	Peel and slice	8 - 10
Apricot and Peach	Cut into two pieces and remove the stone	4 - 6
Strawberry and Blackberry	Wash and hull	8 - 12
Cooked fruits	Add 10 % of sugar to the container	12
Plum, cherry, raspberry	Wash and hull the stems	8 - 12

	MAXIMUM STORAGE TIME (MONTHS)	THAWING TIME AT ROOM TEMPERATURE (HOURS)	THAWING TIME IN OVEN (MINUTES)
Bread	4 - 6	2 - 3	4-5 (220-225 °C)
Biscuits	3 - 6	1 - 1.5	5-8 (190-200 °C)
Pastry	1 - 3	2 - 3	5-10 (200-225 °C)
Pie	1 - 1.5	3 - 4	5-8 (190-200 °C)
Filo dough	2 - 3	1 - 1.5	5-8 (190-200 °C)
Pizza	2 - 3	2 - 4	15-20 (200 °C)
DAIRY PRODUCTS	PREPARATION	MAXIMUM STORAGE TIME (MONTHS)	STORAGE CONDITIONS
Packet (Homogenized) Milk	In its own packetwashing	2 - 3	Pure Milk – in its own packet
Cheese - excluding white cheese	In slices	6 - 8	Original packaging may be used for short-term storage. Keep wrapped in foil for longer periods.
Butter, margarine	In its packaging	6	

CLEANING AND MAINTENANCE

Disconnect the unit from the power supply before cleaning.

Do not wash your appliance by pouring water on it.

Do not use abrasive products, detergents or soaps for cleaning the appliance. After washing, rinse with clean water and dry carefully. When you have finished cleaning, reconnect the plug to the mains supply with dry hands.

- › Make sure that no water enters the lamp housing and other electrical components.
- › The appliance should be cleaned regularly using a solution of bicarbonate of soda and lukewarm water.
- › Clean the accessories separately by hand with soap and water. Do not wash accessories in a dishwasher.
- › Clean the condenser with a brush at least twice a year. This will help you to save on energy costs and increase productivity.

NOTE:

The power supply must be disconnected during cleaning.

REPLACING LED LIGHTING

To replace any of the LEDs, please contact Caple Service to arrange. This should only be performed by a qualified electrician.

WHEN THE APPLIANCE IS NOT IN USE

When the appliance is not in use for long periods, disconnect from the electricity supply, empty all of the food and clean the inside. Leave the door open to prevent the build-up of odours.

POWER FAILURE

If there is a power failure during the storage of frozen foods, keep the door closed.

If the temperature within your freezer should rise, do not refreeze the food without checking its condition.

DEFROSTING:

NOTE:

Care must be taken when performing the following procedure.

Defrost twice a year or when a frost layer of approximately 7mm (1/4") has formed.

- › 2 hours before the defrosting process, set the thermostat knob to "5", to make sure the food is at the lowest temperature before removing the frozen foods. All food should be wrapped in several layers of newspaper and stored in a cool place (e.g. fridge or larder).
- › Place several layers of new paper or towels underneath and next to the freezer door/ compartment.
- › Switch off the appliance at the socket outlet and pull out the mains plug.
- › Remove all drawers, baskets, etc. and leave the door open. Containers of warm water (not hot) may be placed carefully in the freezer to speed up the defrosting process.
- › Never use hairdryers, electrical heaters or other such electrical appliances for defrosting.
- › When the ice has melted, clean and dry the interior. Wipe up any spillages that may have occurred.
- › Switch the appliance on and replace any frozen food.



CAUTION:

Never use sharp metal tools as it may damage the appliance. Never use an electrical heater, this may cause an electric shock.

TRANSPORT AND REPOSITIONING

TRANSPORTATION AND CHANGING POSITIONING

- › The original packaging and foam may be kept for re-transportation (optional).
- › Fasten your appliance with thick packaging, bands or strong cords and follow the instructions for transportation on the packaging.
- › Remove all movable parts (shelves, accessories, vegetable bins, and so on) or fix them into the appliance against shocks using bands/tape when re-positioning or transporting. Always carry your appliance in the upright position.

TROUBLESHOOTING

BEFORE CALLING FOR SERVICE

Reviewing the information below may save you from calling for service.

THE APPLIANCE DOES NOT OPERATE CHECK IF:

- › There is power to the unit
- › The general switch in your home is connected
- › The socket is working. To check this, plug in another appliance that you know is working into the same socket.
- › The fuse has not blown
- › The voltage is correct for the appliance
- › There has been a power cut

THE APPLIANCE PERFORMS POORLY CHECK IF:

- › You have not overloaded the appliance
- › The freezer temperature set to MAX
- › The door is closed perfectly
- › There is no dust on the condenser
- › There is enough space at the rear and side walls for ventilation

THE INTERNAL TEMPERATURE OF THE APPLIANCE IS TOO COLD

- › Increase the temperature by adjusting the thermostat to a lower setting. The highest setting should only be used as a rapid cool and only set 2 hours before a large amount of food is placed in the freezer.

THE APPLIANCE DOORS DO NOT CLOSE PROPERLY CHECK IF:

- › There are no obstructions preventing door closure
- › The door compartments and shelves are correctly in place
- › Check the door seal is not warped or torn
- › Check the appliance is level

THE APPLIANCE HAS ODOUR / SMELLS CHECK IF:

- › All the food and drink that is in the freezer is in date and correctly packaged.
- › There are any spillages on each shelf, rack and drawer.
- › The drainage pipe is not clogged or the drip tray at the back of the appliance is full.
The pipe can be cleared by pouring hot water through. You must ensure the appliance is turned off, the plug is removed from the socket and a jug or bucket is in place to catch the flow of water.

SHORT CRACKING:

- › Heard when the thermostat switches the compressor on/ off.

COMPRESSOR NOISE:

- › Normal motor noise. This noise means that the compressor operates normally. Compressor may cause more noise for a short time when it is activated.

BUBBLING NOISES:

- › This noise is caused by the flow of the refrigerant in the tubes of the system.

AIR BLOW NOISE:

- › Normal fan noise. This noise can be heard in freezers during normal operation of the system due to the circulation of air.

EXCESS ICE OR FROST IN SIDE THE APPLIANCE :

- › Check the door has not been left open.
- › Check the door gasket is clean and undamaged.

DOOR JOINTS:

- › If the edges of freezer cabinet that the door joint contact are warm; especially in summer (hot weather), the surfaces that the joint contact may get warmer during the operation of the compressor, this is normal. If humidity builds up inside the freezer;
- › Is all the food packed properly?
- › Are the containers dried before placing them in the freezer?
- › Is the freezer door opened frequently? Humidity of the room gets in the freezer when the door is opened. Humidity build up will be faster when you open the door more frequently, especially if the humidity of the room is high.

IF THE DOORS ARE NOT OPENED AND CLOSED PROPERLY

- › Do the food packages prevent closing of the door?
- › Are the door compartments, shelves and drawers placed properly?
- › Are door joints broken or torn?
- › Is your freezer on a level surface?

IF THE INNER / OUTER SURFACES ARE WET

- › Caused by condensation. Dry the inside of the appliance.

RECOMMENDATIONS

- › To stop the appliance completely, unplug from main socket (for cleaning and when the door is left open).

If the problem persists or more help is required, please contact our Caple service team on **0117 938 7420** or via email service@caple.co.uk.

SPARE PARTS AVAILABILITY

The original spare parts for some specific components are available for a minimum of 7 or 10 years, based on the type of component, from the placing on the market of the last unit of the model.

For more info and to order spares, please contact Caple service or visit our website www.caple.co.uk

ENERGY SAVING TIPS

1. Install the appliance in a cool, well ventilated room, but not in direct sunlight and not near a heat source (such as a radiator or oven) otherwise an insulating plate should be used.
2. Allow warm food to cool before placing them inside the appliance.
3. Avoid keeping the doors open for long periods and opening the doors too frequently as warm air will enter the appliance and cause the compressor to switch on unnecessarily often.
4. Keep the covers of the different temperature compartments (such as the crisper and chiller) closed.
5. The door gasket must be clean and pliable. Replace gaskets if worn.

NOTES



Caple Service
Fourth Way
Avonmouth
Bristol
BS11 8DW

T: 0117 938 1900
E: service@caple.co.uk
www.caple.co.uk