



# Fridge Freezer Instruction Manual

---

# CAFF24



Contact Cable on 0117 938 7420 for spare parts or [www.cable.co.uk](http://www.cable.co.uk)





## CONTENTS

Safety Instructions	3
Installation Warnings	8
Parts of the Appliance	11
Transport	12
Installation	12
Before Operating your Appliance	14
Operation	15
Fridge Compartment	17
Freezing Compartment	19
Storage of Foods	20
Energy Saving Tips	20
Cleaning	21
General Information	22
Troubleshooting	23

## SAFETY INSTRUCTIONS

### CAUTION:

Read these instructions carefully and completely before using your appliance, keep it in a convenient place for reference when necessary.

- This appliance can be used by children aged from 8 years and above.
- Persons with reduced physical, sensory or mental capabilities or lack of experience and knowledge must be supervised and given appropriate instruction concerning the use of the appliance in a safe way and understand the hazards involved.
- Children shall not play with the appliance.
- Cleaning and user maintenance should not be carried out by children without supervision.
- Children aged from 3 to 8 years are allowed to load and unload refrigerating appliances.

### CAUTION:

- The refrigerant isobutene (R600a) is contained within the refrigerant circuit of the appliance, a natural gas with a high level of environmental compatibility, which is nevertheless flammable.
- During transportation and installation of the appliance, ensure that none of the components of the refrigerant circuit becomes damaged.
- The refrigerant (R600a) is flammable.

## CAUTION:

- This appliance is not intended for use by persons (including children) with reduced physical, sensory or mental capabilities, or lack of experience and knowledge, unless they have been given supervision or instruction concerning use of the appliance by a person responsible for their safety.
- Children should be supervised to ensure that they do not play with the appliance.

## CAUTION:

- Do not use or store inflammable materials ether, benzene, alcohol, medicine, LP gas, spray or cosmetics near or in the fridge. It may cause an explosion or fire.
- Do not put glassware in the freezing chamber or refrigerator chamber air outlet, it may cause an explosion or hurt.
- Make sure of grounding:
  - Consult a qualified electrician or service person if the grounding instructions are not completely understood, or if you have doubts on whether the appliance is properly grounded.
  - The incorrect grounding may cause breakdown and electric shock.
  - Do not store explosive substances such as aerosol cans with a flammable propellant in this appliance.

## IMPORTANT NOTE:

This product is not designed for commercial use, it is a household appliance only. It is not intended to be used in:

- Staff kitchen areas in shops, offices and other working environments.
- Bed and breakfast type environments.
- By clients in hotels, motels and other residential type environments.
- Catering and similar non-retail applications.

Please read this booklet before installing and switching on this appliance. Cagle take no responsibility for incorrect installation and usage as described in this booklet.



Symbol ISO 7010 W021

Warning; Risk of fire / flammable materials



e

## WARNING:

- The appliance must be positioned so that the plug is accessible.
  - If the supply cord is damaged, it must be replaced by the manufacturer, its service agent or similarly qualified persons in order to avoid a hazard.
  - Keep ventilation openings, in the appliance enclosure or in the built-in structure, clear of obstruction.
  - Do not use mechanical devices or other means to accelerate the defrosting process, other than those recommended by the manufacturer.
  - Do not damage the refrigerant circuit.
  - Do not use electrical appliances inside the food storage compartments of the appliance, unless they are of the type recommended by the manufacturer.
  - This unit is using R600a as the Refrigerant and cyclopentane as Foaming Agent, both of these kinds of materials are flammable, so the abandoned unit should be kept away from fire.
  - Danger of electrical shock, the yellow-green earthwire of this appliance must be earthed before operation.
  - The refrigerant and insulation blowing gas are flammable. When disposing of the appliance, do so only at an authorised waste disposal centre. Do not expose to flames.
  - When positioning the appliance, ensure the supply cord is not trapped or damaged.
  - Do not locate multiple portable socket-outlets or portable power supplies at the rear of the appliance.
- To avoid contamination of food, please respect the following instructions:
    - Opening the door for long periods can cause a significant increase of temperature in the compartments of the appliance.
    - Regularly clean surfaces that come in contact with food and accessible drainage systems.
    - Store raw meat and fish in suitable containers in the refrigerator, so that it is not in contact with or drips onto other food.
  - Two-star(\*\*) frozen-food compartments are suitable for storing pre-frozen food, storing or making ice-cream and making ice cubes.
  - One star(\*), two star(\*\*) and three star(\*\*\*) compartments are not suitable for the freezing of fresh food.
  - If the refrigerating appliance is left empty for long periods, switch off, defrost, clean, dry, and leave the door open to prevent mould developing within the appliance.



## INSTALLATION WARNINGS

- » The dedicated outlet should be used. Using several devices at one outlet may cause fire.
  - » Install the appliance in a dry, well ventilated room.
  - » The appliance should be placed close to socket as it is easy to cut off the power supply at the time of an accident.
  - » Do not allow the power plug to face upward or to be squeezed at the back of the fridge. Water may be flown into or the plug may be damaged, which causes fire or electric shock.
  - » Do not allow the power cord to be bent or pressed by a heavy object, or it may be damaged. If it is damaged, it must be replaced by the manufacturer, its service agent or similarly qualified persons in order to avoid a hazard.
  - » Unplug the power plug when cleaning or handling the interior lamp of the fridge. It may cause electric shock or injury.
  - » If the LED lamp is damaged, it must be replaced by the manufacturer or its service agent.
  - » Remove water or dust from the power plug with a dry clean cloth, do not use wet hands.
  - » Do not touch food or containers in the freezer with wet hands. It may cause frostbite.
  - » Do not place any heavy or dangerous object e.g. a cup, flower vase, cosmetics, medicine or any container with water on the fridge. It may fall and cause injury, fire or electric shock when opening or closing the door.
  - » Do not spray water on the outside or the inside of the fridge and do not clean it with benzene or thinner.
  - » Wait for 5 minutes or longer when reconnecting the plug. It may cause the operation of the freezer to fail.
  - » Do not use the fridge for non-domestic purposes (storing medicine or testing material, blood etc.) It may cause an unexpected risk such as fire, electric shock, deterioration of stored material or chemical reaction.
  - » Do not use a drier to dry the inside, nor light a candle to remove odor. It may cause an explosion or fire.
  - » Do not cling to the door or the trays of the door. It may make the fridge to fall down, causing damage and injury. Especially, do not allow children to do the above.
  - » When gas is leaked, do not touch the fridge or the outlet and ventilate the room immediately. The explosion may cause fire or burn.
  - » Damage during delivering, installing or using the fridge may cause gas to leak. Any spark may cause fire or burn. If it is damaged on delivery contact your retailer.
- » Do not insert hands or metal stick into the exit of cool air, the cover, the bottom of the fridge or the heatproof grill (exhaust hole) at the back. It may cause electric shock or injury.
  - » Do not put ice in thin crystal cups or ceramic ware. It may break the cup or ceramic ware and cause injury.
  - » Do not use the fridge if it becomes submerged in water. It may cause electric shock or fire.
  - » Do not install the fridge in a wet place or place where water or rain splashes. Deterioration of insulation of electrical parts may cause electrical leakage. Please check the fridge regularly.
  - » Do not allow any person except the qualified engineer to disassemble, repair or alter the fridge. It may cause injury, electric shock or fire.



C



### ENVIRONMENTAL PROTECTION

Waste electrical products should not be disposed of with household waste. Please recycle where facilities exist. Check with your Local Authority or retailer for recycling advice. This appliance is marked according to the European directive on Waste Electrical and Electronic Equipment (WEEE).

By ensuring this product is disposed of correctly, you will help prevent potential negative consequences for the environment and human health, which could otherwise be caused by inappropriate waste handling of this product. The symbol on the product indicates that this product may not be treated as household waste. Instead it shall be handed over to the applicable collection point for the recycling of electrical and electronic equipment. Disposal must be carried out in accordance with local environmental regulations for waste disposal.

For more detailed information about treatment, recovery and recycling of this product, please contact your local council, your household waste disposal service or the retailer where you purchased the product.

### CE DECLARATIONS OF CONFORMITY



This appliance has been manufactured to the strictest standards and complies with all applicable legislation, Low Voltage Directive (LVD) and Electromagnetic Compatibility (EMC).



## PARTS OF THE APPLIANCE

All figures in this manual are schematic; some features and devices may not be consistent fully with your refrigerator and the specific structure and configuration shall be subject to the actual product.

### IMPORTANT NOTE:

The appearance and specifications of the actual product may differ depending on the model.

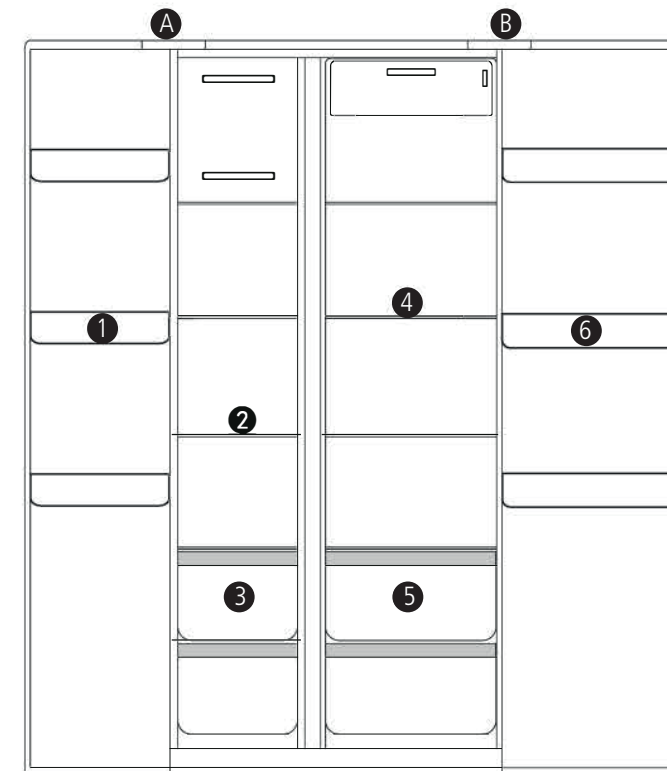

#### A) FREEZER COMPARTMENT

1. Freezer door tray
2. Freezer glass shelves
3. Freezer drawer

#### B) REFRIGERATOR COMPARTMENT

4. Refrigerator glass shelves
5. Refrigerator drawer
6. Refrigerator door tray

## TRANSPORT

- » Do not carry the refrigerator horizontally.
- » Do not carry the refrigerator by holding the door or handle; the refrigerator shall be carried by lifting the bottom.

## INSTALLATION

Select a good location to place your appliance where it is flat and easy to use. Avoid placing the unit near heat sources, direct sunlight or moisture.

Fig 1

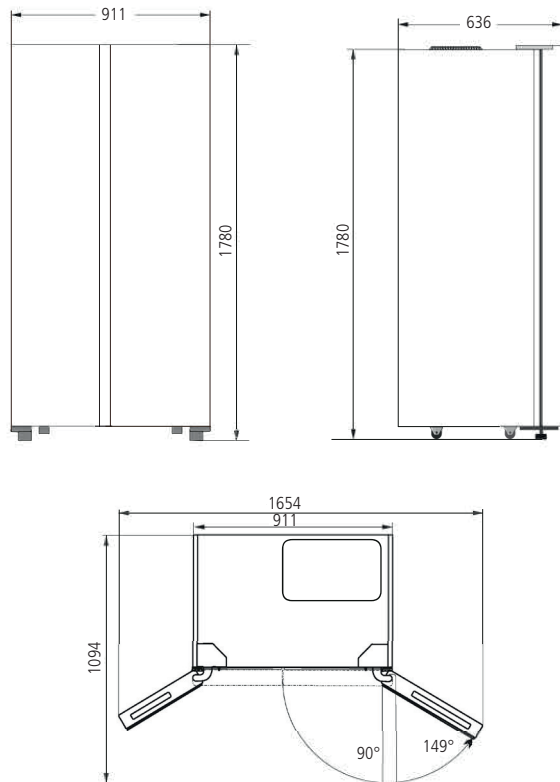

To ensure proper air circulation around the fridge, please maintain sufficient space between fridge and surroundings.

## LOCATION AND POSITIONING:

- » The refrigerator must be placed on a hard, flat ground; if cushioning is needed, stable, hard, nonflammable cushion blocks shall be used, rather than the foam backing of refrigerator.
- » The refrigerator shall be kept away from damp locations where water is easy to splash; water or dirt shall be removed with soft cloth to prevent rusting which may have an effect on the electrical characteristics.
- » Place the refrigerator in a well-ventilated place, reserve a certain space around and behind the refrigerator (as per the recommendations in Figure 2), and do not cover or block the air grille on the rear cover plate of compressor at the back of refrigerator. Keep the refrigerator away from heat sources or direct sunlight.

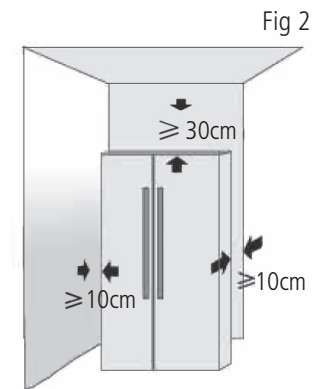

## ADJUST PLASTIC FEET:

- » When the refrigerator stays in the packing box, plastic feet are in tightened state. After removing from the packing box for placement, please make sure to adjust two front plastic feet until the height is suitable; adjust the two plastic feet with a wrench or directly by hand.
- » Plastic feet and rear rollers must touch the ground to prevent the refrigerator from movement, vibration or noise. When moving the refrigerator, adjust plastic feet counterclockwise to keep them off the ground, and then push the refrigerator gently to move it.

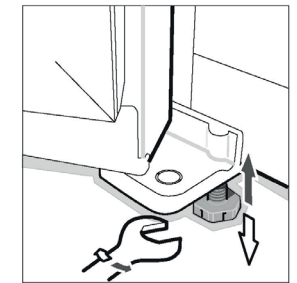

## BEFORE OPERATING YOUR APPLIANCE

- » Remove all packaging, including the foam backing at the bottom of refrigerator and the tape fixing accessories in the box.
- » Place the refrigerator to a proper position, and adjust the feet to level. It is better to clean the refrigerator before use.
- » Remove the film: There is a layer of transparent film on the panel of our product, which can protect products from being scratched in the process of production and transportation, and you can choose to reserve or remove the film as needed.
- » Place the refrigerator and adjust to correct level, clean it, let the refrigerator stand for 12 hours, and then power on to ensure that the refrigerator can operate normally.

## STARTING AND FUNCTION SETTING

### STARTING:

- » Connect the power cord and turn on the power switch.
- » Upon startup for the first time, the screen will display respective set temperature values (the temperature of the refrigerating chamber is set at 5°C, the temperature of the freezing chamber at -18°C).

### FUNCTION SETTING OF LED DISPLAY:

- » The default mode is energy saving upon startup: The screen displays for 20 seconds and then goes off. This mode is to save energy and prolong the service life of LED lights.

## OPERATION

### CONTROL PANNEL:

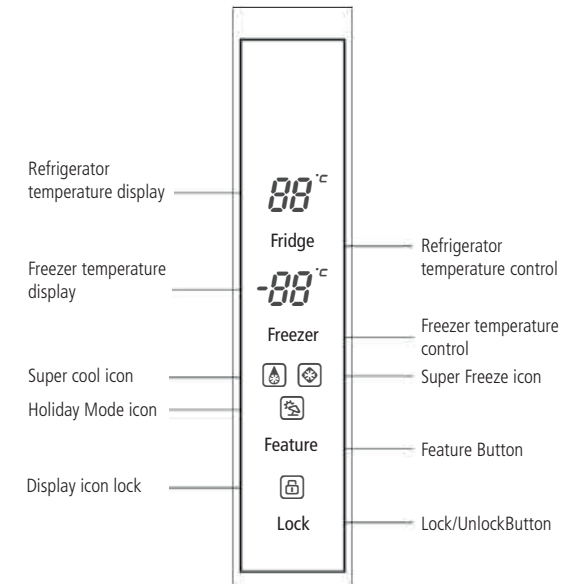

Each press of the "Feature" button will cycle through the operating modes.

- » Holiday Mode - The refrigerator will run at 6°C while the freezer operates at -15°C.
- » Super Freeze Mode - When the super freeze mode is selected, the compressor will operate continuously to freeze foods faster, and keep them fresh. The super freeze mode will automatically turn off either after 24 hours of operation, or when the freezer reaches -28° C. The super freeze icon will turn off and the freezer will continue to operate at the normal set temperature.
- » Super Cool Mode - When the super cool mode is selected, the fridge compartment reaches the set temperature in the shortest period, in order to keep the food as fresh as possible. In this mode, the set temperature of the fridge compartment locks on 0°C. The program runs for 150mins maximum, then exits automatically, the super cool icon goes out, meaning the super cool function is disabled. The set temperature will return to the set temperature before the super cool mode was operated.

## FREEZER COMPARTMENT SETTINGS

The default temperature of the freezer is -18°C. To change the temperature press the “Freezer” button to cycle through the set temperatures.

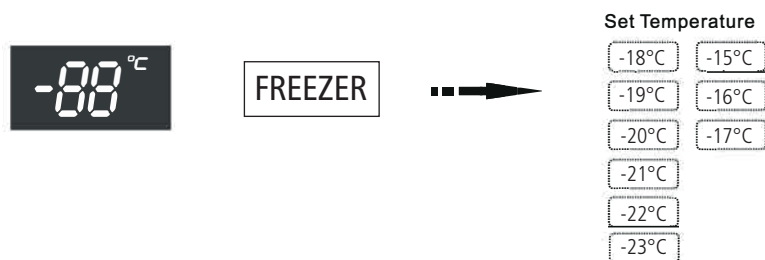

### IMPORTANT NOTE:

Do not put fresh foods directly on frozen foods.

## REFRIGERATOR COMPARTMENT SETTINGS

The default temperature of the refrigerator is 5°C. To change the temperature press the “Fridge” button to cycle through the set temperatures.

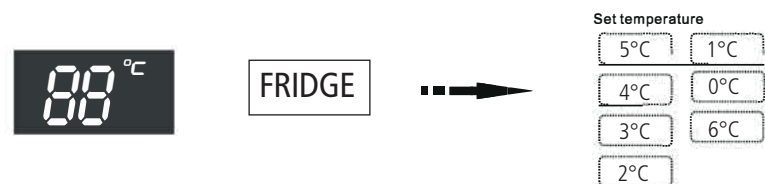

## LOCK/UNLOCK BUTTON

- » This product has button lock function.
- » Pressing the “Lock” button will enable lock mode and the lock icon will be visible.
- » While the refrigerator is in this mode the other buttons on the control panel will not function, when the buttons are touched a chime will sound and the lock icon will flash.
- » To exit lock mode press and hold the lock button for 3 seconds until the icon is no longer displayed.



## OPEN DOOR ALARM

When the refrigerator door is open for more than 1 min, the buzzer will alarm to remind users to close the door. After the door is closed, the alarm sound will stop automatically.

## REFRIGERATOR COMPARTMENT

### IMPORTANT NOTE:

The refrigerator compartment is mainly used to store foods that are preserved for a short time.

The refrigerator compartment is suitable for storing fruits, vegetables, drinks and other foods that will be eaten recently. It is suggested to seal foods and then put them into the refrigerator.

Suggested sections of refrigerator chamber for various foods and variety name:

1. Glass shelves: wheat foods, milk, etc.
2. Drawer: fruits, vegetables, etc.
3. Top tray: dairy products, odorous foods, etc.
4. Bottle rack: bottles, thinly packaged food.

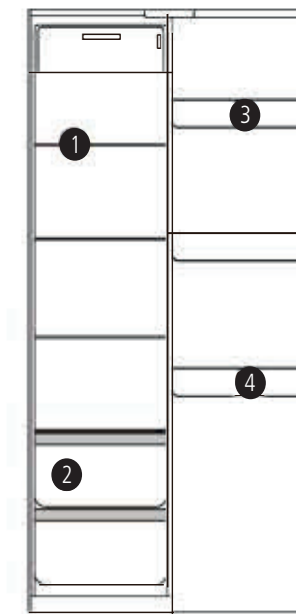

**SALAD CRISPER:**

The refrigerating compartment has a salad crisper, which can retain the moisture of fruits and vegetables and keeps the humidity of the box correct. It is suitable for storing fruits and vegetables.

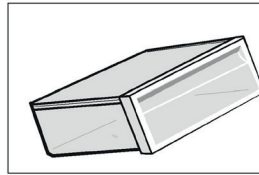
**GLASS SHELVES:**

When removing the glass shelf, please press the movable pin under the shelf with both hands and push inward at the same time. Then the glass shelf will be removed.

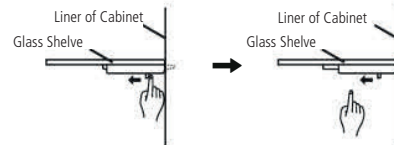
**DOOR STORAGE RACK:**

**Disassembly:** Hold both sides of the door storage rack with both hands. Push it from the side without the lug and push it inward as the direction of the arrow. When pushing hard, please note that the buckle on the edge of door storage rack is separated from the groove of the liner. Then door storage shelf can be removed.

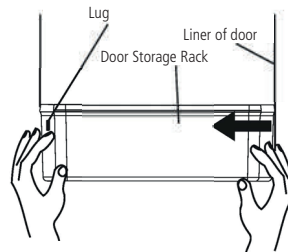
**INSTALLATION:**

Hold both sides of the door storage rack with both hands. Install the buckle of the lug side at first. Then push the other side inward slightly, the buckle can be fixed.

**FREEZER COMPARTMENT**

The freezer compartment is used to freeze foods, store frozen foods and make ice cubes. It can preserve foods for a long time.

The freezer compartment is suitable for retaining the freshness of the foods for a long time. When storing meat, it is suggested to cut the meat into pieces which are easy to take out, and mark the freezing date to prevent foods from exceeding the time limit.

Suggested sections of the freezer compartment for various foods and variety name:

1. Upper bottle rack: small frozen articles
2. Glass shelf: frozen foods, such as fish, meats and ice creams
3. Drawer: packaged frozen foods, etc.

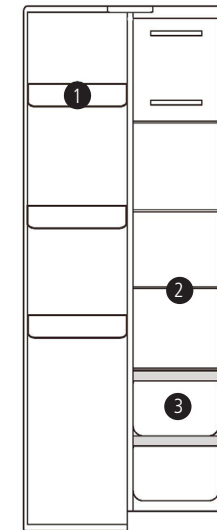
**FREEZER COMPARTMENT DRAWERS:**

The upper drawer in the freezer compartment can freeze and store large-volume foods. The lower drawer is mainly used to store frozen foods.

**CAUTION:**

Oily food which is stored in the refrigerator must avoid direct contact with the liner. When the interior is stained with oil or oily food stains, it should be cleaned immediately to avoid the prolonged contact with the liner, which may lead to liner corrosion and cracking.

**DEFROSTING:**

This production has an automatic defrosting function, without manual operation.

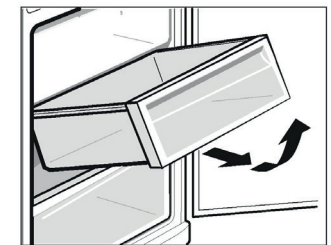



C

## STORAGE OF FOODS

### CAUTION:

Instructions for storing foods:

- » When storing freezing foods, put them inside the freezer compartment, rather than the bottle rack.
- » Do not put bottled or canned foods into the freezer compartment to prevent frost cracking.
- » Before putting hot foods into the refrigerator, cool them to room temperature first; otherwise, they will increase power consumption. Mark the freezing date on the packaging bag according to different storage lives of foods, so as to prevent foods from exceeding the time limit.
- » Divide foods into pieces and package them separately, which are easy to freeze thoroughly and will not frozen together.
- » The packaging materials should be odorless, airtight, watertight and pollution-free, so packaged foods are not easy to taint by other odor, without quality reduction.
- » Do not put too many fresh foods into the freezer compartment once. Do not exceed the freezing capacity value of refrigerator.
- » Melted foods can not be frozen again, unless they are made into dishes; otherwise, their service quality will be affected.
- » Glass bottles or glass containers shall not be placed into the freezing chamber at the air outlet of the refrigerating compartment duct; otherwise, they may explode.
- » Foods can not block the air outlet; otherwise, abnormal air circulation will be caused.

## ENERGY SAVING TIPS

- » Make sure to keep the refrigerator away from heat sources and direct sunlight.
- » Before storing hot foods, cool them to room temperature and then put into refrigerator.
- » Close the door timely to reduce the opening frequency and shorten the opening time.
- » When unfreezing frozen foods, you can put them into the refrigerating chamber, which will assist in refrigeration of the refrigerating compartment.
- » Make sure that the temperature sensor is not covered or blocked by foods, and is kept a good distance from foods.

## CLEANING

Precautions for internal and external cleaning of refrigerator:

- » Before cleaning, always turn off the power switch and disconnect the power plug.
- » During cleaning, make sure that no water will enter the switch, control panel, door lamp and top control box.
- » Remove dirt from the outside of the refrigerator with mild cleaner, then wipe with a clean soft cloth and let the refrigerator dry naturally.
- » When cleaning the door sealing strip, always use clean water, wipe with dry cloth and let it dry naturally. Use a wet soft cloth with warm water or neutral cleaner to wipe the refrigerator body except the door sealing strip.
- » It is forbidden to flush the refrigerator directly with water, which will affect electrical insulation properties, etc.
- » It is forbidden to clean the refrigerator with metal wipers, wire brushes, coarse abrasive cleaners, strong alkaline detergents, or flammable or toxic cleaning fluids.

### IMPORTANT NOTE:

After cleaning, connect the power plug of the refrigerator back to the power supply.

## GENERAL INFORMATION

### HOLIDAY:

When you want to leave for holiday, it is better to let the refrigerator operate continuously and leave foods that can be stored for a short time. If you want to stop the refrigerator, remove all foods, disconnect the power plug, clean the inside of refrigerator fully, and open the door to avoid producing abnormal odors.

### POWER FAILURE:

Generally, short-term power failure will not affect the temperature of the refrigerator harshly. However, if power failure lasts for a long time, you should reduce the opening frequency of the refrigerator, and should not put fresh foods into the refrigerator (prevent rise in the temperature of refrigerator from speeding up).

If you know power failure is coming, you can turn on the "Super Freeze" function in advance to keep the temperature of refrigerator to the lowest value.

### SHUTDOWN:

Generally, it is not suggested to stop the refrigerator or turn off the power switch; otherwise, the life of refrigerator may be affected.

### BUTTON FAILURE:

Please check the control board to see whether the fridge under lock mode. When under lock mode, all buttons are disabled.

### LONG TIME TO START:

When the ambient temperature is too high, it will take a longer time for the appliance to start and reach the set temperatures.

### MIDDLE BEAMS FEEL HOT:

The middle beams between the two compartments feel hot after a period of time, this is normal.

### CONDENSATION:

When external air flows into the cool inner surface of the fridge, condensation can be formed. If the humidity of the installed location is high condensation can form on the outer side of the fridge. This is natural and occurs during humid weather. Wipe the water drops with a dry cloth.

### NOISE:

When you operate the fridge for the first time, the fridge will operate at high speed to cool fast and the sound can seem louder. When the internal temperature falls below a certain level, the noise will subside.

When the operation of the compressor is starting or ending various parts expand/contract various control devices operate or temperature changes within the fridge, you will hear noises, these are normal.

### HOT COMPRESSOR:

When working, the temperature on the outside of the compressor is more than 80°C, please do not touch the compressor, it may cause serious injury.

### COMPRESSOR RUNNING FOR A LONG TIME:

When the temperature is too high or there are too many fresh foods in the fridge, it will take a long time to cool down until the appliance runs at the setting temperature.

## TOUBLESHOOTING

Before calling for service, review this list. It may save you both time and expense. This list includes common occurrences that are not the result of defective workmanship or materials in this appliance.

FAULT	POSSIBLE CAUSE	REMEDIAL ACTION
No display on the display panel	<ul style="list-style-type: none"><li>» The mains plug of the appliance is not in the socket properly.</li><li>» The fuse for the domestic supply is switched off.</li></ul>	<ul style="list-style-type: none"><li>» Check whether the power is on; the fuse must be switched on.</li></ul>
Alarm sound	<ul style="list-style-type: none"><li>» Door is slightly open or not closed for more than 1 minute.</li></ul>	<ul style="list-style-type: none"><li>» Close the door completely.</li></ul>
The compressor does not work	<ul style="list-style-type: none"><li>» It's under defrosting mode.</li><li>» Power is not connected well.</li></ul>	<ul style="list-style-type: none"><li>» It's normal for defrosting; Check whether the power is connected well.</li></ul>
Compressor runs for too long	<ul style="list-style-type: none"><li>» The fridge has recently been disconnected for a period of time.</li><li>» Too much fresh or hot food.</li><li>» Doors are opened too frequently or for too long.</li></ul>	<ul style="list-style-type: none"><li>» It takes some hours for the fridge to cool down completely;</li><li>» Hot food will cause the fridge to run longer until the desired temperature is reached;</li><li>» Warm air entering the fridge cause it to run longer. Open the door less often.</li></ul>
Vibrating noise	<ul style="list-style-type: none"><li>» Floor is uneven or weak.</li><li>» Items placed on the top of the fridge are vibrating.</li><li>» Fridge is touching wall or cabinets.</li></ul>	<ul style="list-style-type: none"><li>» Be sure floor is level and solid and can adequately support fridge;</li><li>» Remove items.</li><li>» Move fridge so that it does not touch the wall or cabinets.</li></ul>



Caple Service

Fourth Way

Avonmouth

Bristol

BS11 8DW

T: 0117 938 7420

E: [service@caple.co.uk](mailto:service@caple.co.uk)

[www.caple.co.uk](http://www.caple.co.uk)

