



MOT910

Caple Motus 90cm cooker hood



Technical information

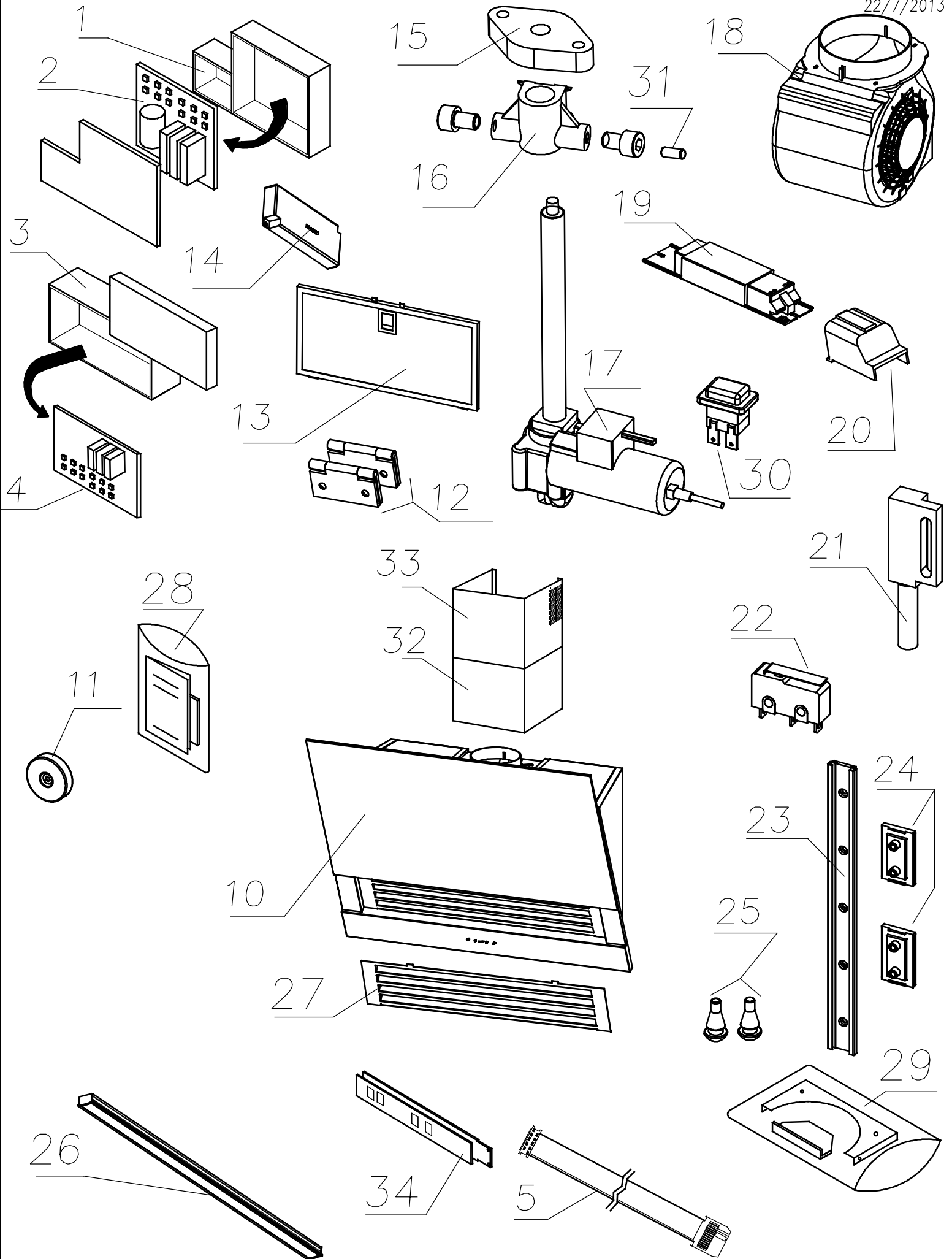



MOT910 - Caple Motus cooker hood

Item	Part Code	Description	Qty
1	75071439999	WIRING BOX SET	1
2	44001599999	MAIN BOARD S-DD1 POWER	1
3	75072600100	S-DD2 WIRING BOX	1
4	44023000027	SCHEDA IMP. ELETTRICO SLTC/ATT.	1
5	44024999366	M/F FLAT CABLE SDD4/5	1
10	75421207256	ASS. R. VETRO SLTC75 90 CAPLE ASS-N256 BLACK	1
11	60041091553	MAGNET 20X5 COUNTERSUNK	1
12	60186303003	FLAT MILLED HINGE	1
13	60080730000	GREASE FILTER SL73 LFI-M001	1
14	42030122320	TRASFORMATORE EL. DC 12V EFU 122320	1
15	60187540199	SPINDLE SUPPORT	1
16	60187540999	SLIDER ACTUATOR H40 (MODIFIED)	1
17	42007525999	ACTUATOR LM25	1
18	75061509999	MOTOR GPZ900	1
19	42030999999	TRANSFORMER 50 W	1
20	51071100499	TRANSFORMER SAFETY SHROUD	1
21	63504000312	MAGNETIC SENSOR	1
22	60127505000	SECURITY MICROSWITCH	1
23	60180127365	SLIDE NS 01 27 S75	1
24	60180127027	SLIDING BLOCK DRYLING	1
25	51011007501	RUBBER FEET FOR S75 GRATING	1
26	42010515012	LED 515mm (Before Jun-14)	1
26	42010515010	LED 515mm (From Jun-14)	1
27	20001175635	PI. GRIGLIA SL75 90 2013 XS430 MMA-N635	1
28	90042200076	INSTRUCTION MANUAL	1
29	77004037500	A.S.A. SL75 2013	1
30	44001609999	RESET SWITCH	1
31	63504000314	MAGNETIC UNIT	1
32	75024610101	STAINLESS STEEL LOWER CHIMNEY	1
33	75034610101	STAINLESS STEEL UPPER CHIMNEY	1
34	44010759999	BASSETTA COMANDI SLTC/ATT	1

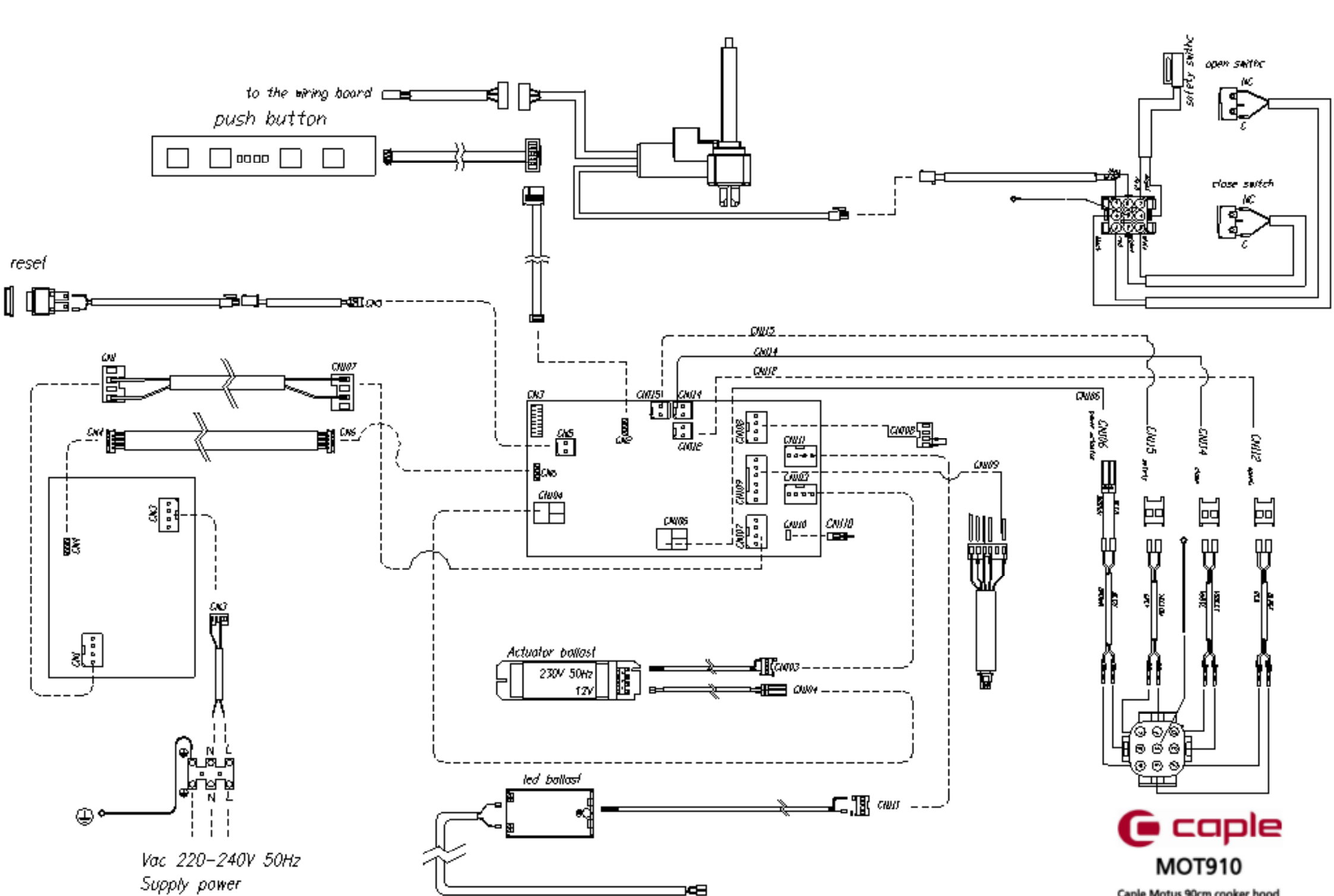

Vac 220-240V 50Hz
Supply power

TROUBLE SHOOTING PROBLEM

SLTR 75 SLTC 75



INDICE

1.	<i>SLTR75 WIRING DIAGRAM</i>	<i>PAG.4</i>
2.	<i>SLTC75 WIRING DIAGRAM</i>	<i>PAG.5</i>
3.	<i>LINE DRAWING</i>	<i>PAG.6</i>
4.	<i>EXPLODED VIEW + SPARE PART LIST SLTR75</i>	<i>PAG.7</i>
5.	<i>EXPLODED VIEW + SPARE PART LIST SLTC75</i>	<i>PAG.8</i>

TROUBLE SHOOTING PROBLEM

THE HOOD DOES NOT WORK

PAG.9

6.	<i>CHECK IF THE HOOD IS PROPERLY CONNECTED</i>	<i>PAG. 9</i>
7.	<i>CHECK IF THE RESET BUTTON IS PRESSED</i>	<i>PAG. 10</i>
8.	<i>CHECK IF THE PUSHBUTTON WORKS PROPERLY</i>	<i>PAG. 11</i>
9.	<i>HOW TO REPLACE THE PUSHBUTTON (SLTC)</i>	<i>PAG. 14</i>
10.	<i>HOW TO REPLACE THE PUSHBUTTON (SLTR)</i>	<i>PAG. 23</i>
11.	<i>HOW TO REPLACE FLAT CABLE</i>	<i>PAG. 35</i>
12.	<i>HOW TO ACCESS TO THE ELECTRICAL SYSTEM</i>	<i>PAG. 36</i>
13.	<i>CHECK THE ELECTRICAL CONNECTOR OF ACTUATOR</i>	<i>PAG. 40</i>
14.	<i>CHECK IF IN THE MAIN PRINT THE CONNECTORS ARE CONNECTED PROPERLY</i>	<i>PAG. 43</i>
15.	<i>REPLACING THE MAIN PRINT</i>	<i>PAG. 44</i>

THE HOOD DOES NOT WORK AND THE LIGHT TURNS ON

PAG. 45

16.	<i>REPLACE THE TRANSFORMER OF THE ACTUATOR</i>	<i>PAG. 45</i>
17.	<i>REPLACE THE CLOSING MICRO SWITCH</i>	<i>PAG. 46</i>
18.	<i>REPLACE THE MOTOR</i>	<i>PAG. 51</i>
19.	<i>REPLACE THE ACTUATOR</i>	<i>PAG.53</i>

ANTI CRUSH SENSOR DOES NOT WORK

PAG. 65

20. REPLACE THE TRANSFORMER OF THE ACTUATOR

PAG. 65

THE HOOD WORKS BUT THE DISPLAY IS OFF

PAG. 69

21. REPLACE THE DISPLAY

PAG. 69

THE HOOD GOES UP TO 4/5 cm THAN IT GOES DOWN AGAIN

PAG. 73

22. CHECK THE FUNCTIONING ENCODER

PAG. 73

THE LIGHT DOES NOT WORK

PAG. 75

23. CHECK THE FUNCTIONING OF THE LED STRIP

PAG. 75

24. REPLACE THE BALLAST

PAG. 77

The hood does not work

6. CHECK IF THE HOOD IS PROPERLY CONNECTED.

- a. Check if the circuit breaker or the corresponding switch inside the house is in the correct position and is working properly.
- b. Check if the tension in the house correspond to that one in the rating plate of the product.
- c. Check if the fuse is intact.
- d. If the hood does not work during the first installation, check if the wiring cable is connected to electricity.

The hood does not work

7. CHECK IF THE RED BUTTON «RESET» IS PUSHED

- a. In the upper side of the hood there is a red button that has the function of turn off the hood. This button must be pushed down.

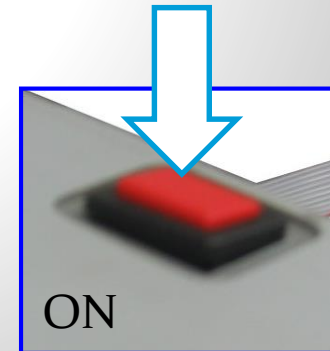
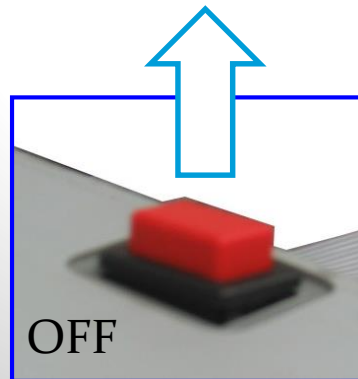

The hood does not work

8. CHECK THE FUNCTIONING OF THE PUSHBUTTON

- a. When the hood is turned on, the speed indicators of the pushbutton light up. Thereafter they turn off but the other remain with low intensity. (in the SLTR version this function is in the display)



The hood does not work

b. lift up the glass for 20 cm in order to activate the security. At this point the glass should open automatically and the motor stay off.



The hood does not work

**If the glass lift up,
(if not go to chapter 9)**

c. The problem is in the pushbutton.



The hood does not work

9. How to replace the touch control SLTC

a. Remove the stainless steel grill.



The hood does not work

d. Unscrew the two screw on the magnet.

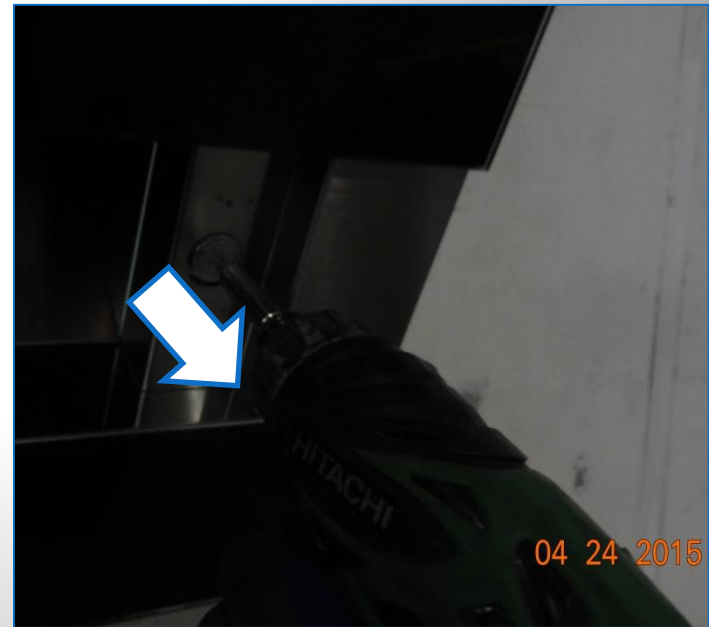

The hood does not work

e. After removing the magnet, the front panel opens



The hood does not work

f. in order to remove the pushbutton is necessary to unscrew by using a tool of 5.5 the two nut in the back of the panel.

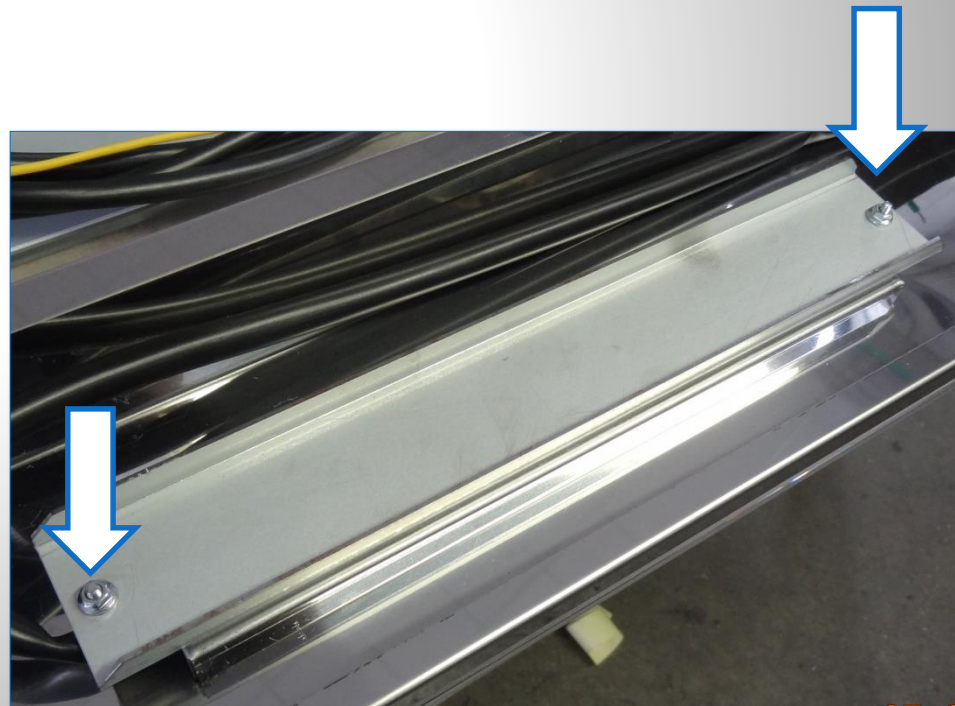
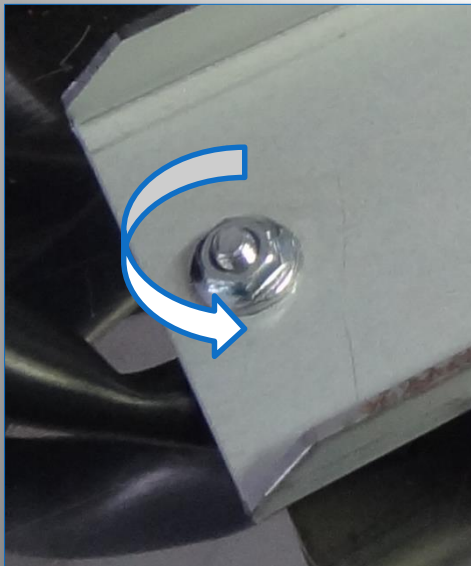

The hood does not work

g. later, remove the stainless steel the cover of the pushbutton by pulling outwards.

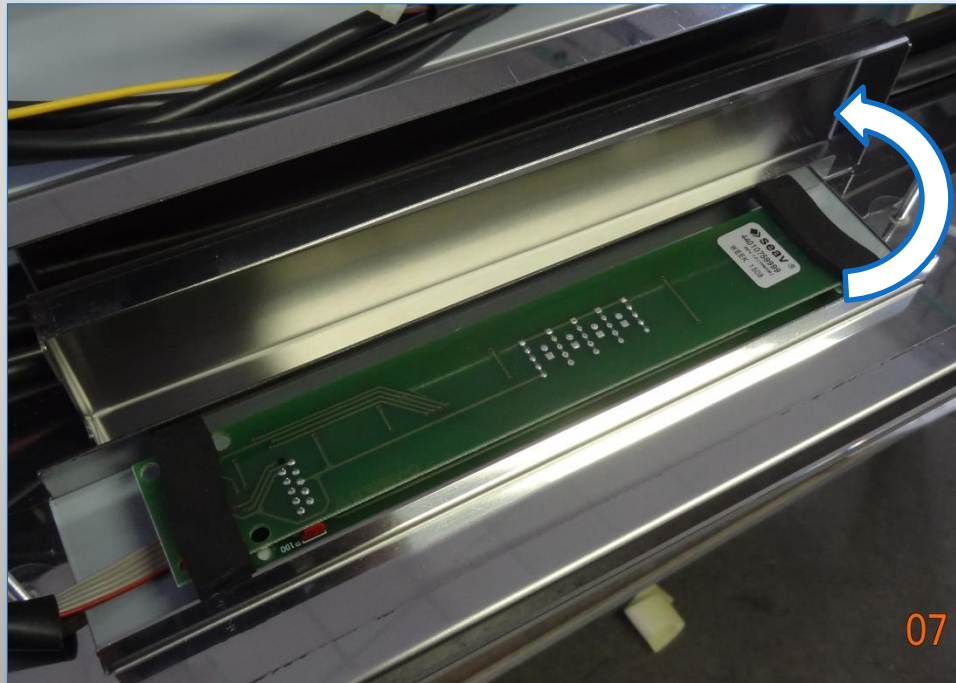

The hood does not work

h. Remove the external wiring board and disconnect the flat cable.

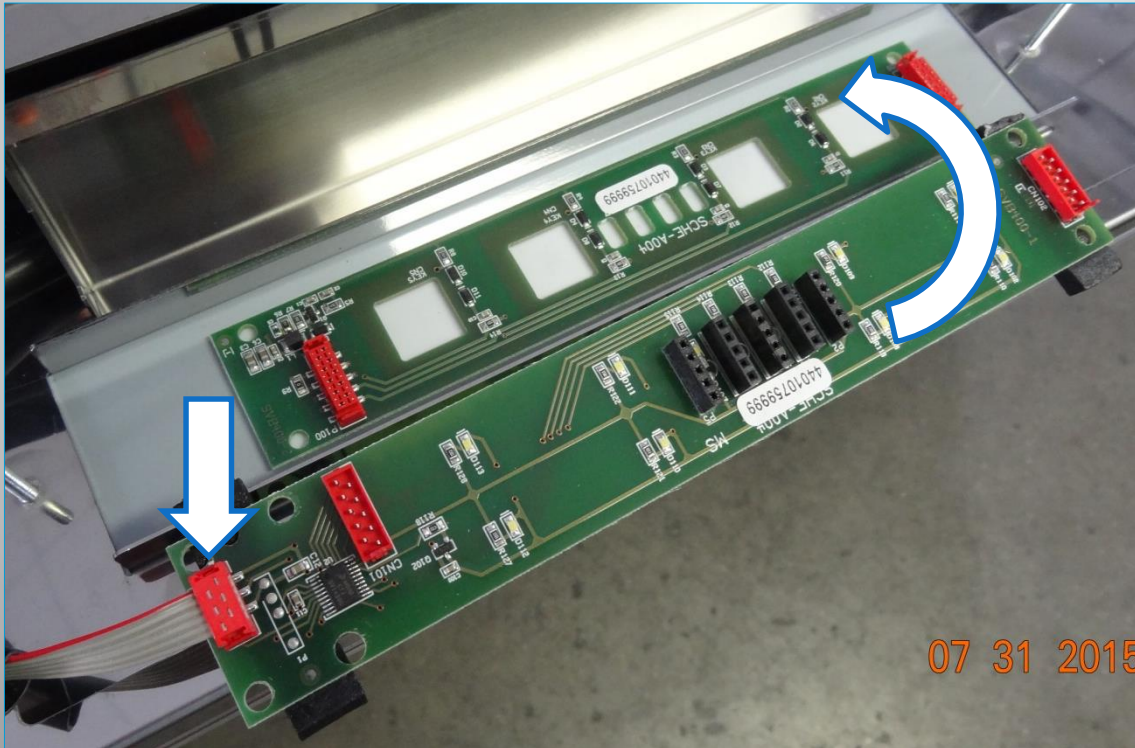

The hood does not work

i. Now remove the wiring board glued on the glass. It is recommended to heat the wiring board with a Phon in order to facilitate the removal. to remove the wiring board use a small screwdriver.

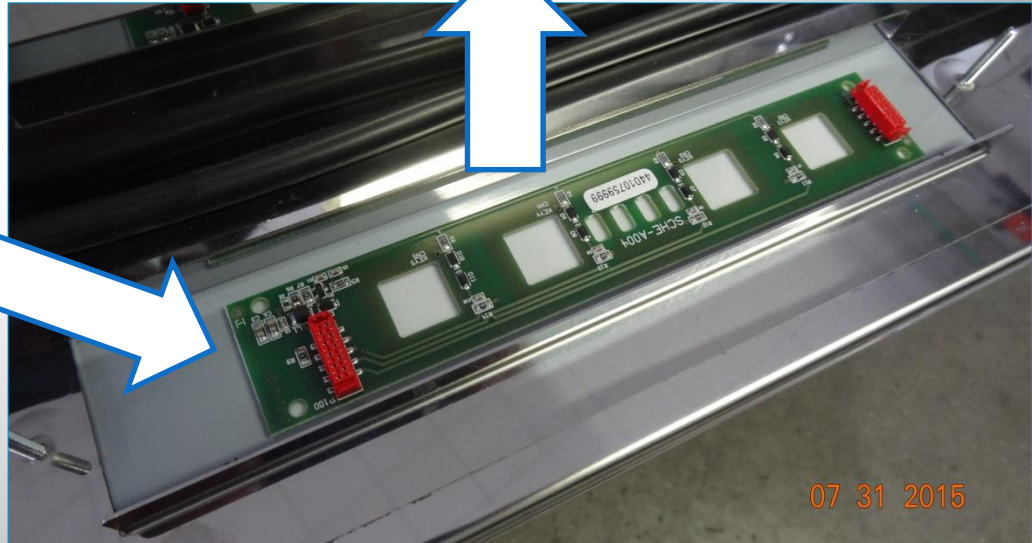

The hood does not work

1. to glue the new wiring board making sure to place the square in correspondance of the symbol on the glass.

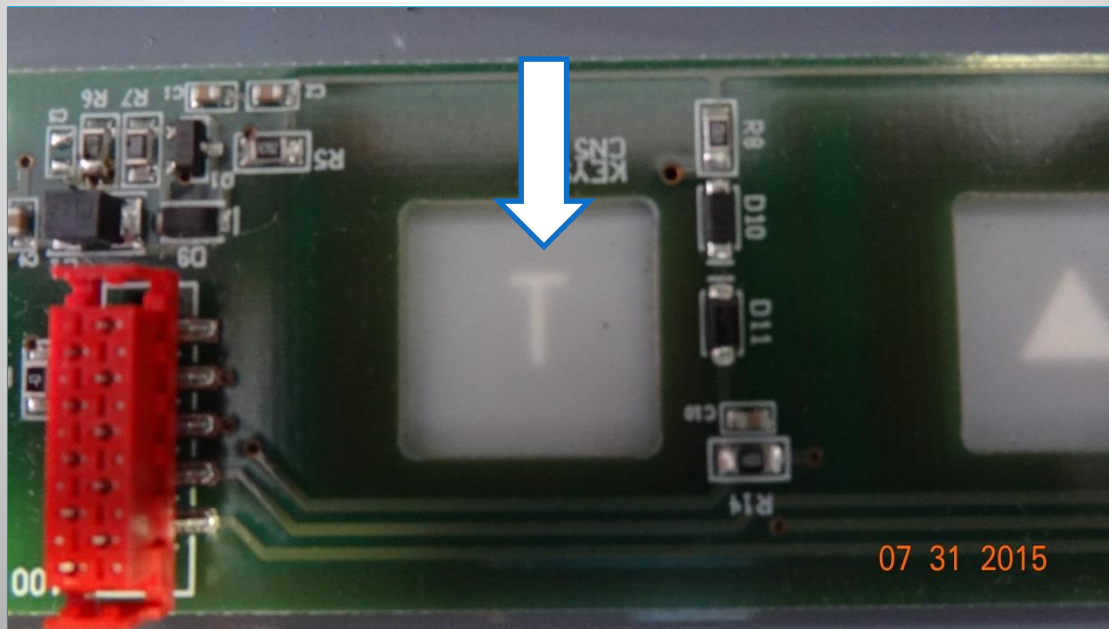

The hood does not work

m. Repeat all the steps backwards to reactivate the pushbutton:

- 1: Reconnect the flat cable,
- 2: place the upper wiring board making sure that the two red connectors coincide,
- 4: replace the stainless steel cover,
- 5: replace the protection and screw the nut.

The hood does not work

10. HOW TO REPLACE THE ROTARY BUTTON (SLTR)

- a. Remove the stainless steel grill.



The hood does not work

d. Unscrew the two screw on the magnet.

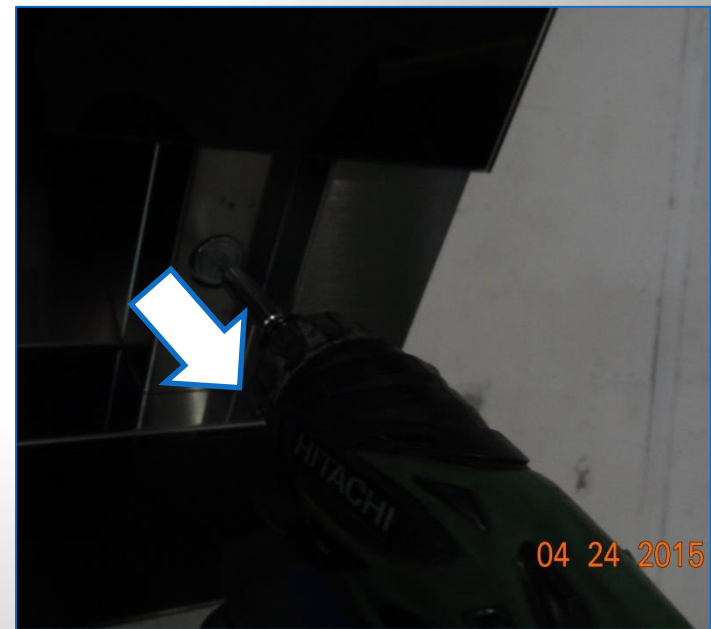

The hood does not work

e. After removing the magnet, the front panel opens



The hood does not work

f. Disconnect the flat cable and the encoder cable

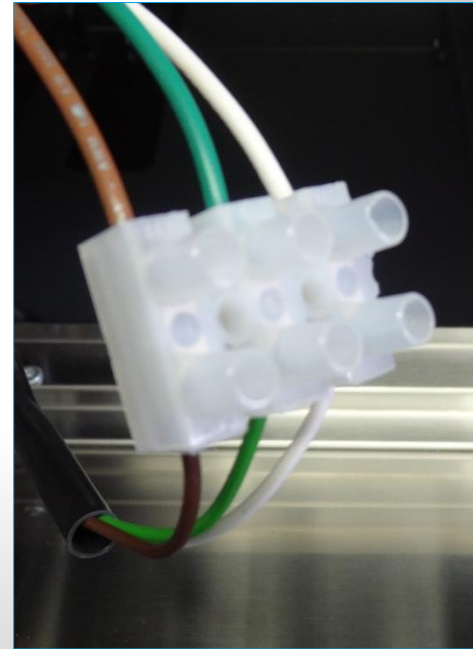
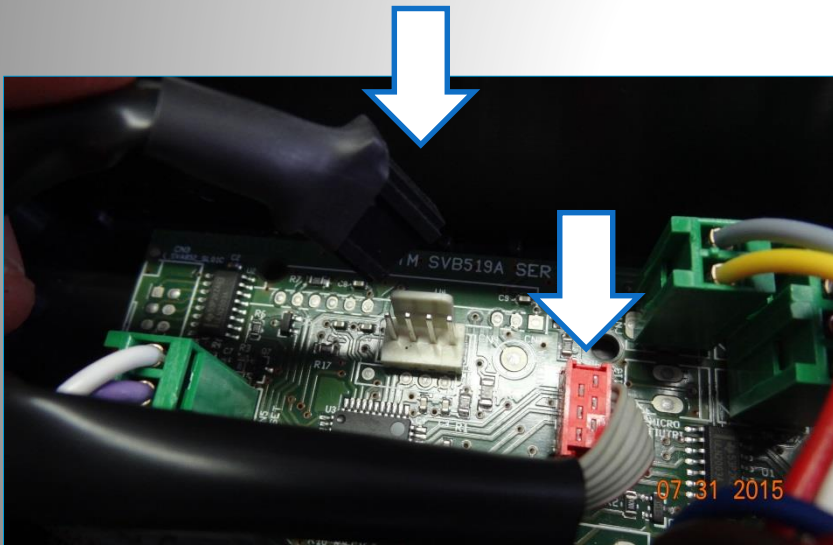

The hood does not work

g. Remove the band in the clamp adhesive



The hood does not work

h. Remove the 4 screw and remove the rotative button.

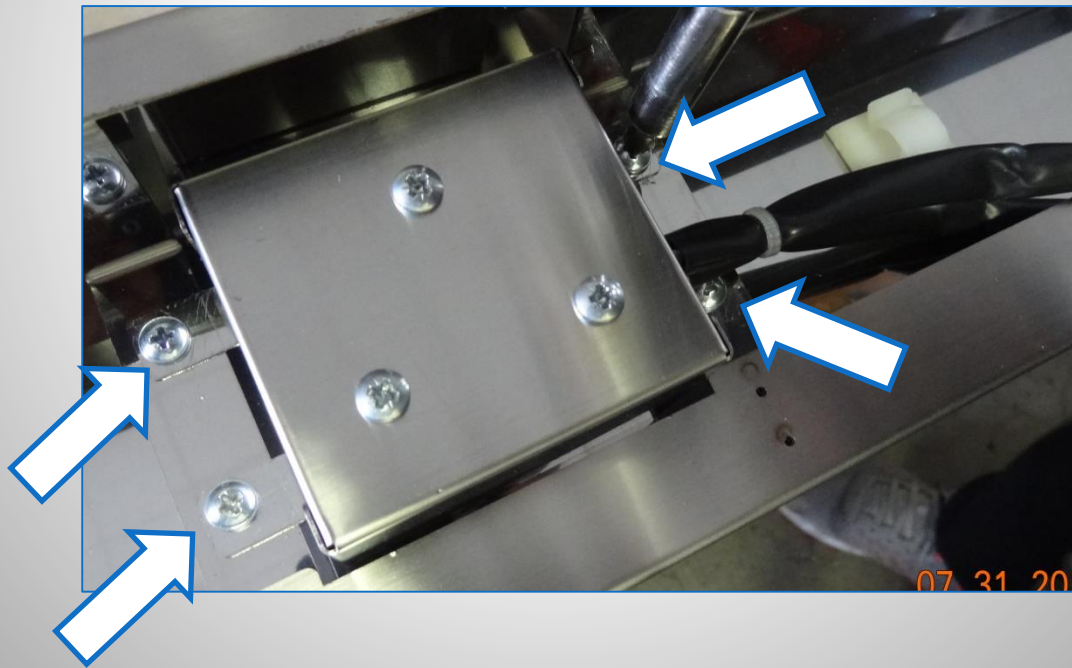

The hood does not work

- i. remove the 3 screw on the wiring board.

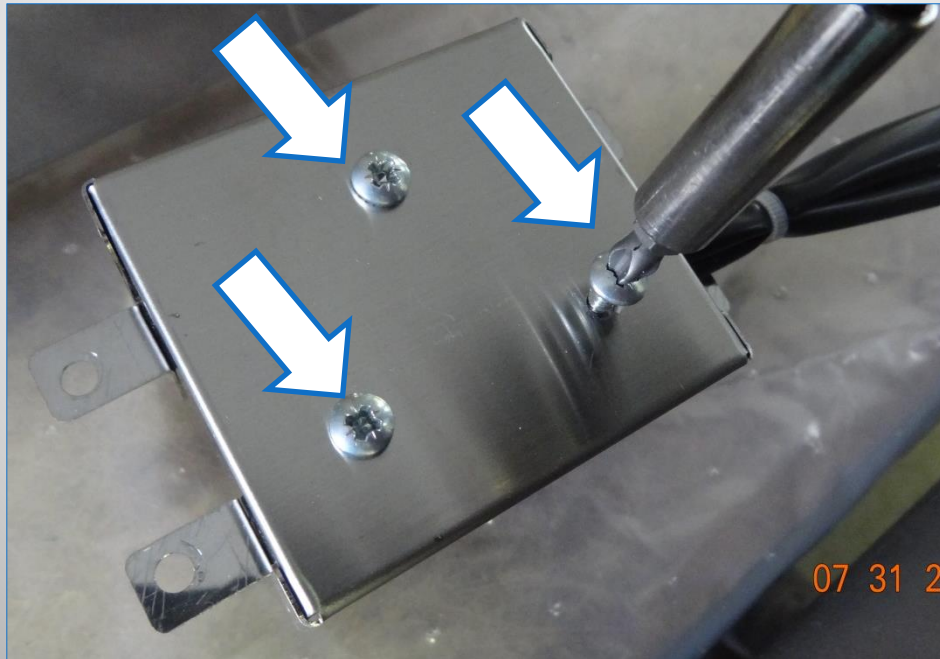

The hood does not work

1. Remove the rectangular fairlead



The hood does not work

m. Remove the wiring board assembly.



The hood does not work

n. Remove the bush holding the knob by using an Allen key 2.5mm .

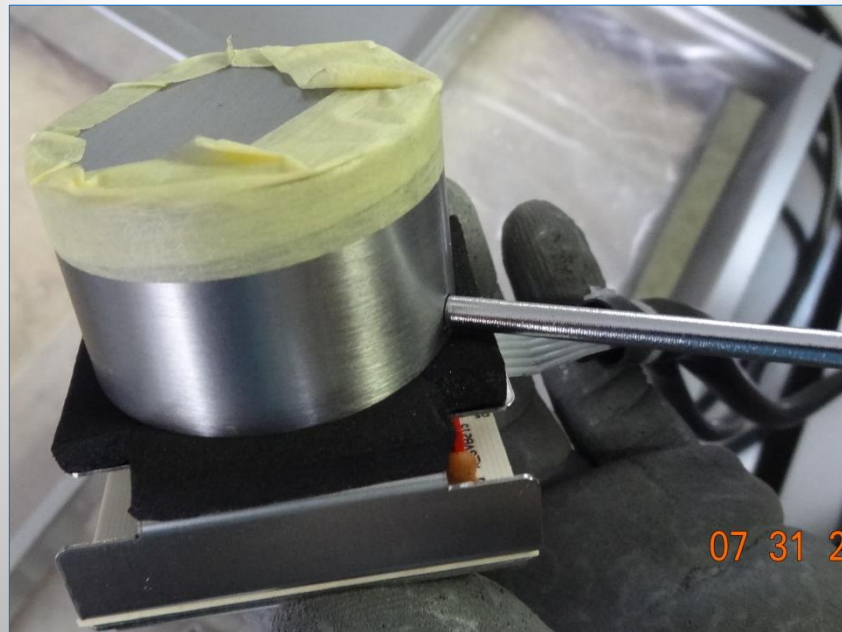

The hood does not work

- o. Remove the four screw holding the wiring board and the connectors the replace with a new one and repeat all the step to reinstate the assembly.

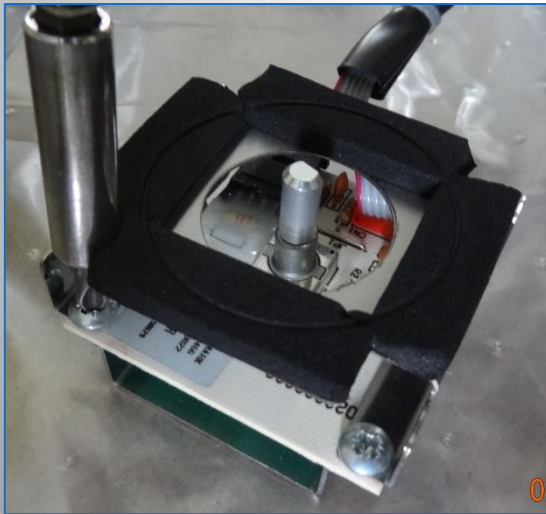

The hood does not work

p. Attn: the knob must be positioned perfectly concentric to the hole otherwise could not rotate easily.



The hood does not work

11. HOW TO REPLACE THE FLAT CABLE

- a. if after the replacement of the pushbutton the problem is not solved, it is recommended to replace the flat cable of the pushbutton, both that of the main print and that of wiring board. It is necessary to open the electrical box (next chapter) and open the rectangular box. Check if the flat is properly connected to the main print. To replace it, unscrew the two screw on the cable.

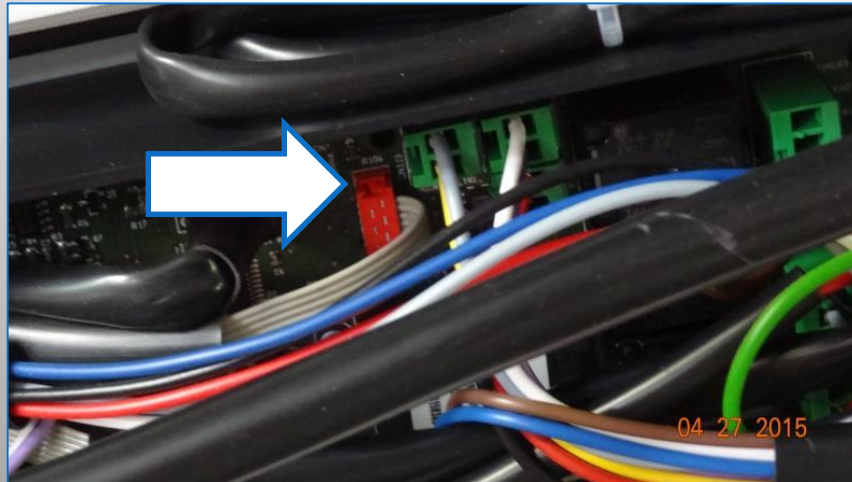

The hood does not work

12. HOW TO ACCESS TO THE ELECTRICAL BOX

This step could be required to carry out several assistance operation.

- a.** Remove the two screw securing the LED strip panel.

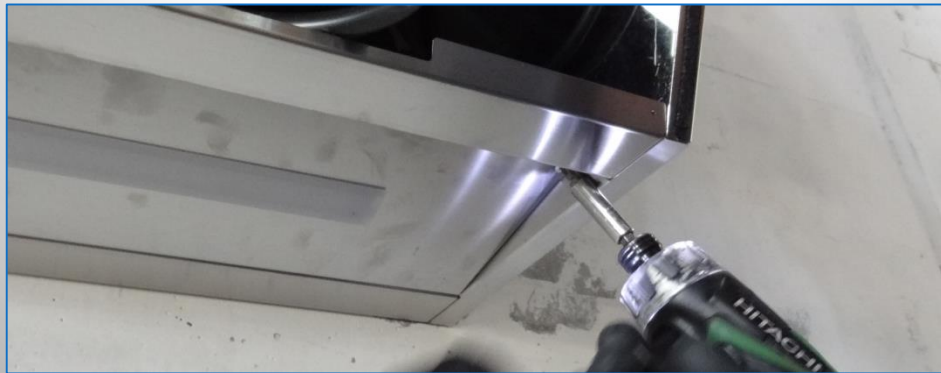

The hood does not work

- b.** Remove the panel and disconnect the two poles connector in the LED strip.



The hood does not work

c. Unscrew the two screws securing the bracket of the electrical system.

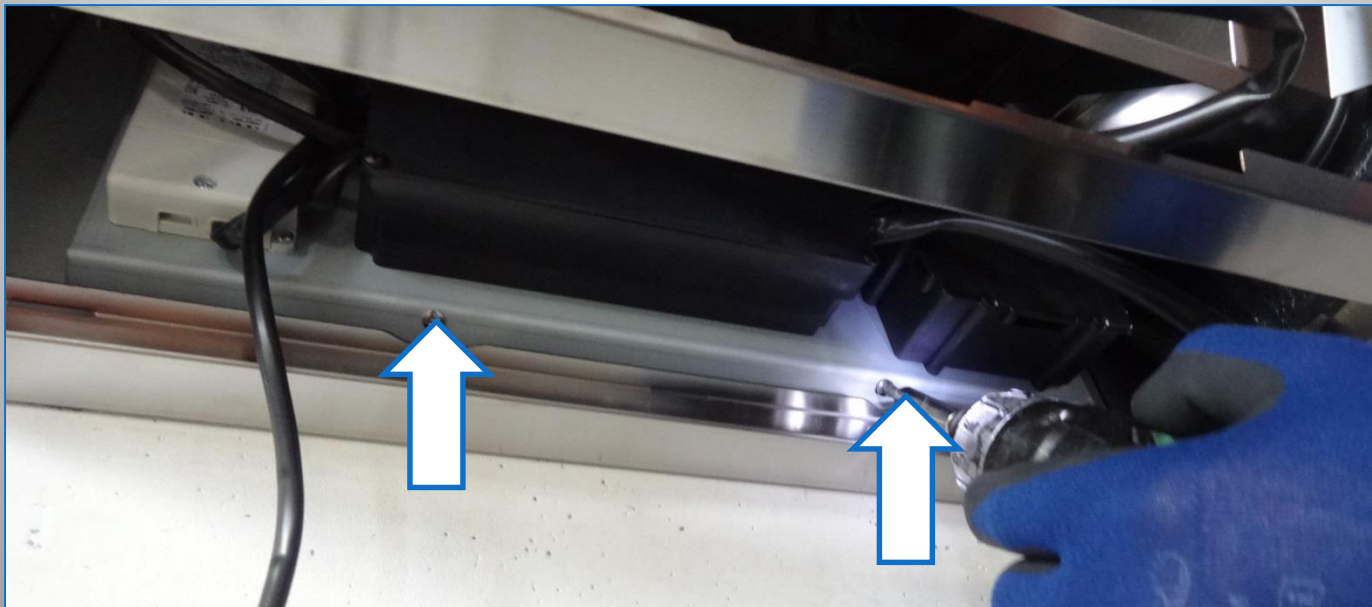

The hood does not work

- d. Remove the electrical system by pulling downward.



The hood does not work

If the glass does **NOT** lift up

13. CHECK IF THE POWER CABLE OF THE ACTUATOR IS PROPERLY CONNECTED.

a. Open the glass manually and keep it open by using some paper tape.

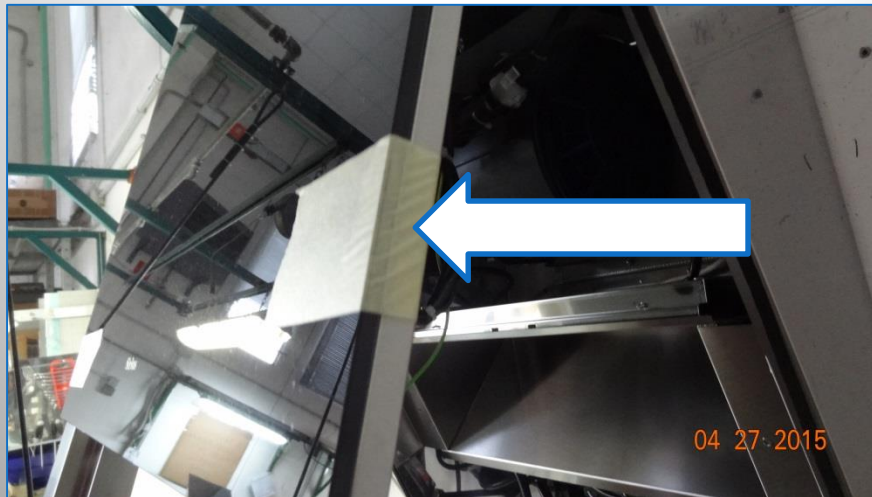

The hood does not work

b. Remove the screw of the magnet (as in chapter 6 c-d-e) and check if the two poles connector with blue and brown cable are connected properly.

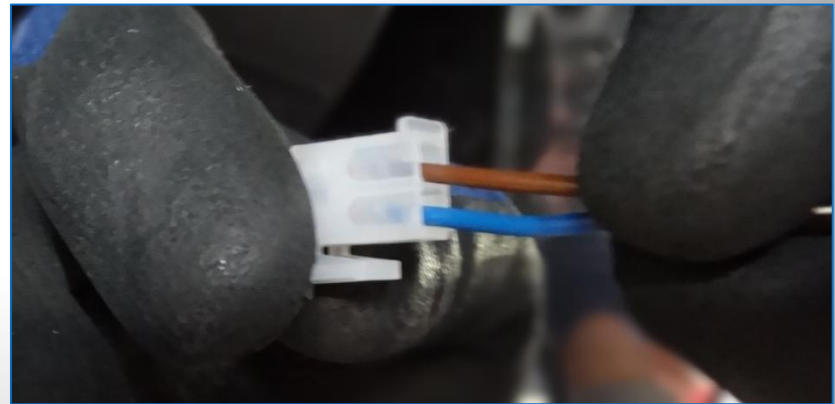

The hood does not work

c. Carry out the same test for the 9 poles connector



The hood does not work

14. CHECK IF IN THE MAIN PRINT ALL THE CONNECTORS ARE PROPERLY CONNECTED.

a. After removing the bracket holding the electrical system (Cap.8), open the cover of the electrical boxes and check if ALL the connectors are properly connected to the wiring board.



The hood does not work

15. HOW TO REPLACE THE MAIN PRINT

- a. Before disconnecting the connectors of the main print it is recommended to take note of the connection on a paper or to take a picture to avoid to reconnecting wrongly the new main print. Check the connections on the wiring diagram at the beginning of this manual.

The hood doesn't work and the lights turn on

16. REPLACE THE TRANSFORMER CONNECTED TO THE ACTUATOR.

- a. After removing the holding bracket of the electrical system (Cap.8), disconnect the cable of the transformer and replace it with a new one. Pay attention to reconnect them accurately.

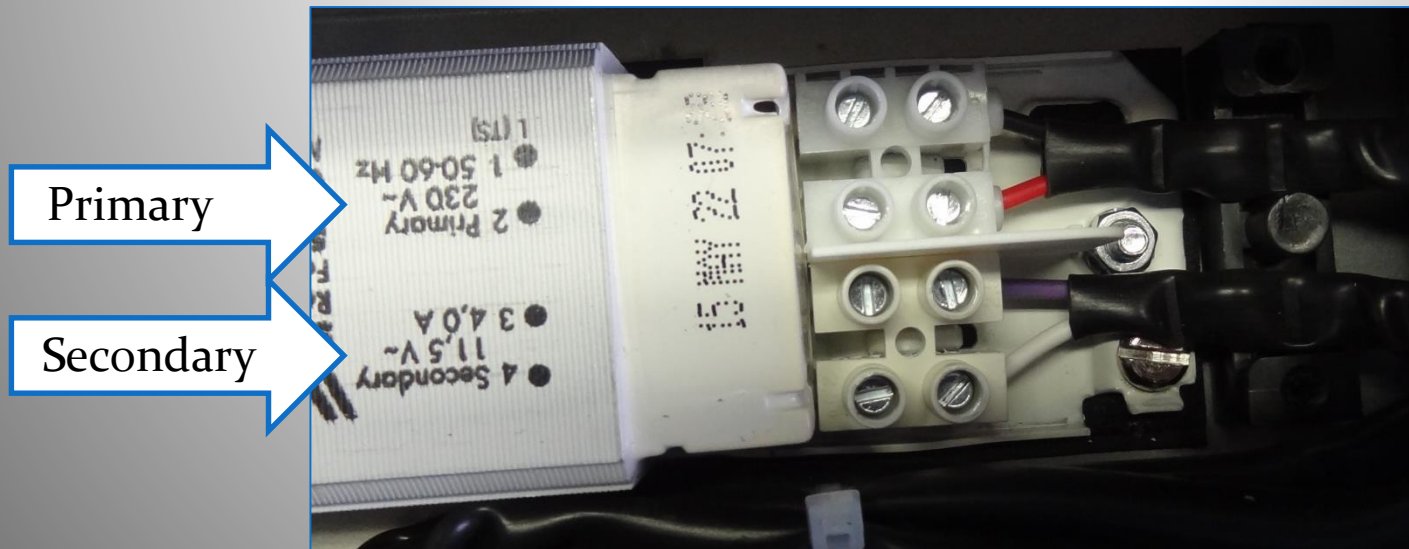

The hood doesn't work and the lights turn on

17. REPLACE THE CLOSING MICRO SWITCH

- a. lift the glass manually and open the hood as shown in Chap. 6 c-d-e.
- b. Remove the cover of actuator assembly

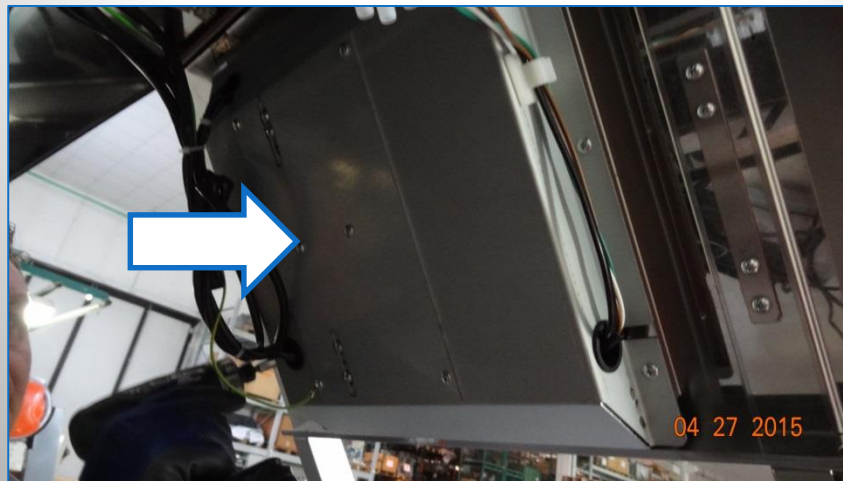

The hood doesn't work and the lights turn on

c. Remove the 2 screws of the micro switch and extract it.

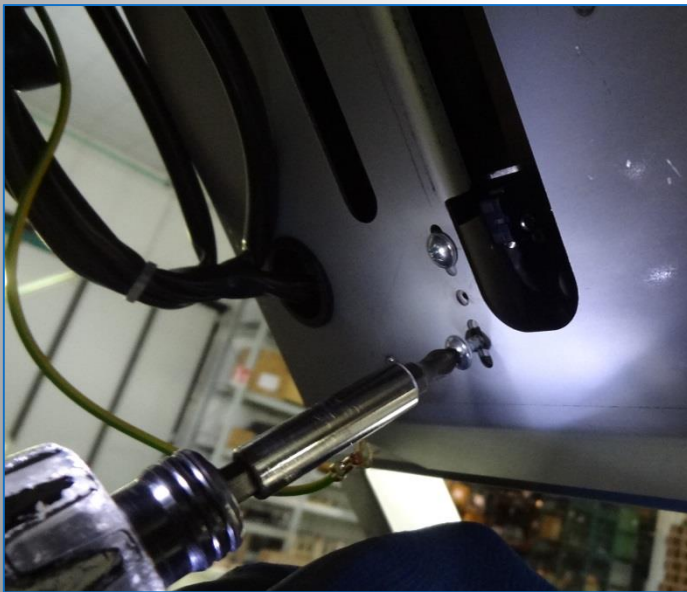

The hood doesn't work and the lights turn on

d. Desolder the cables and unscrew the micro switch from its assembly, replace it with a new one soldering the cables.



The hood doesn't work and the lights turn on

- e. Reassemble the micro switch in its own bracket and secure it in the hood by positioning the bracket in the centre of the loop (att: this adjustment is needed to determine the lower end of the glass)

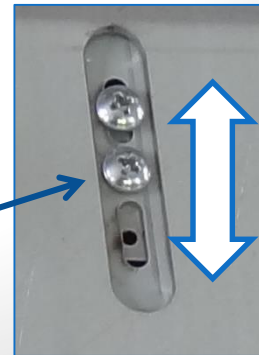
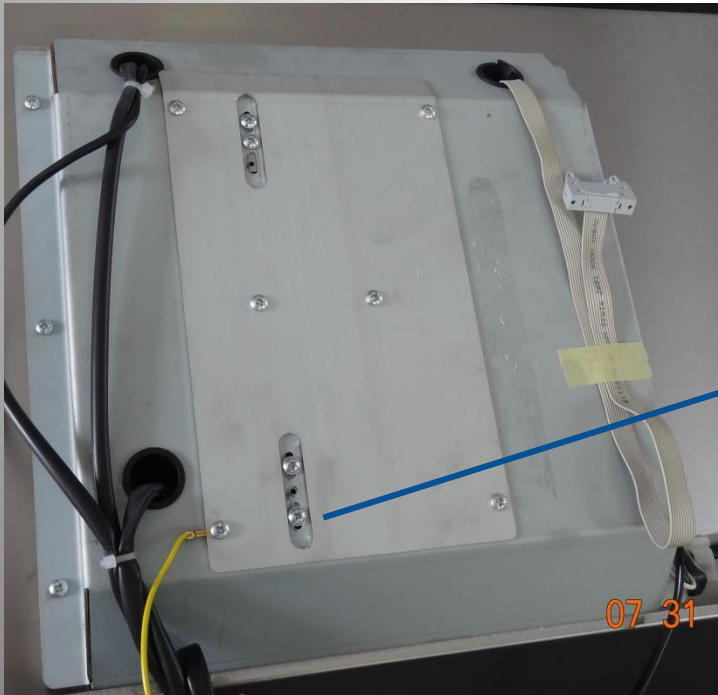

The hood doesn't work and the lights turn on

f. Remove the insulating tape and close manually the glass until complete closure. Now turn on the hood and carry out the functioning test.

The hood doesn't work and the lights turn on

18. REPLACE THE MOTOR

- a. Remove the aesthetic chimney, if there is any .
- b. Remove the screws securing the motor in the upper side of the hood. (ATT. If the motor is pointed towards the posterior side, it is necessary to remove the hood).

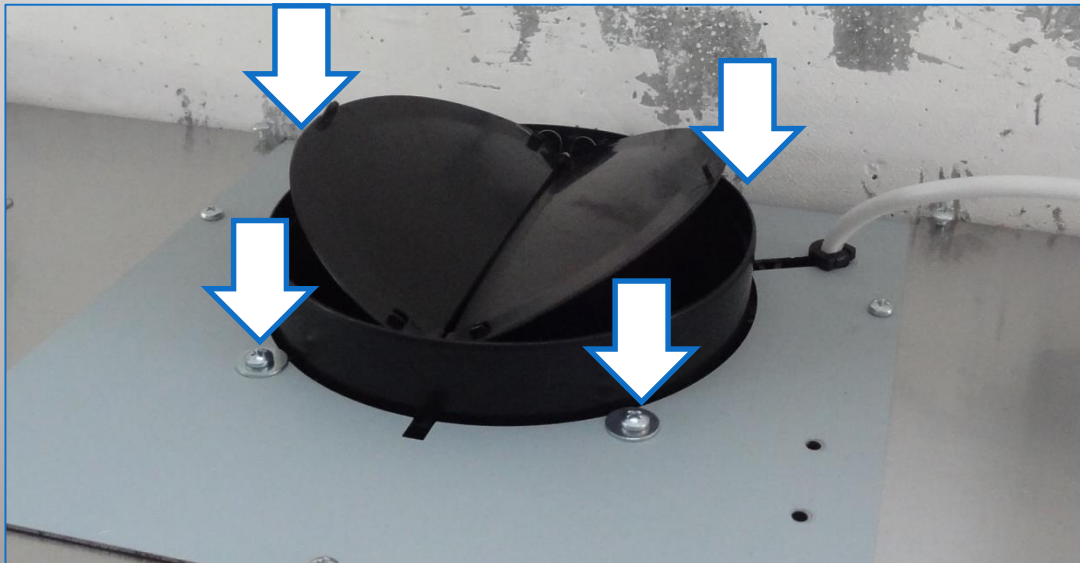

The hood doesn't work and the lights turn on

c. disconnect the 6 poles connector of the motor and replace the suction unit.

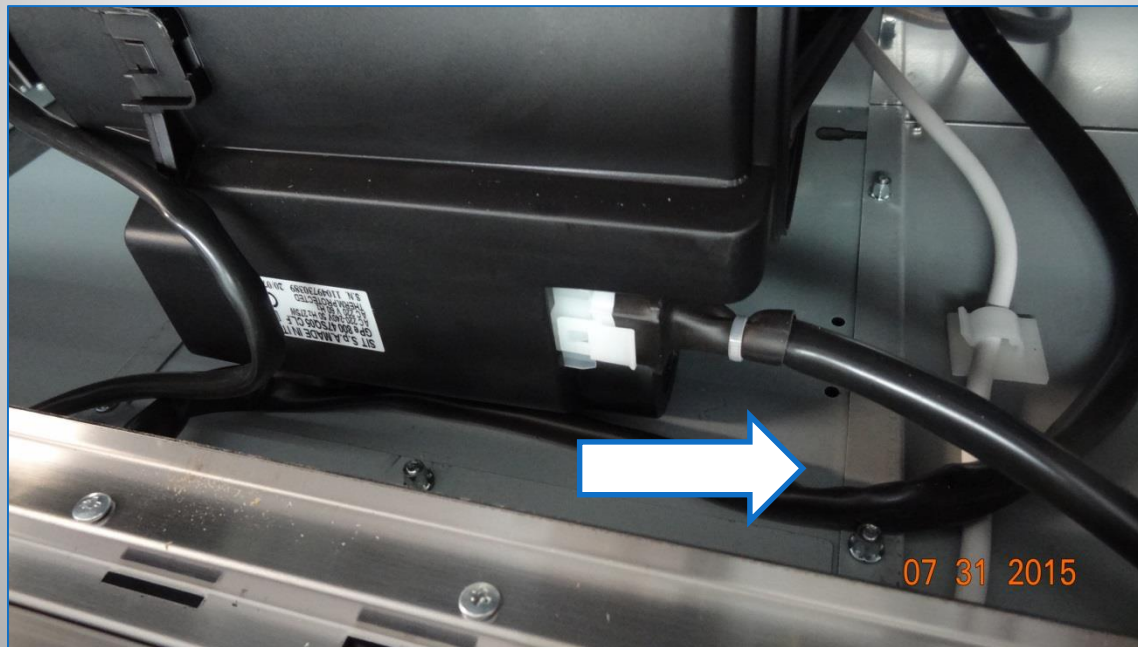

The hood doesn't work and the lights turn on

19. REPLACE THE ACTUATOR

- a. To facilitate the operation, positioning the glass half way and block it with insulating tape.



The hood doesn't work and the lights turn on

b. Keep the front panel open by using some wood slats tailor made

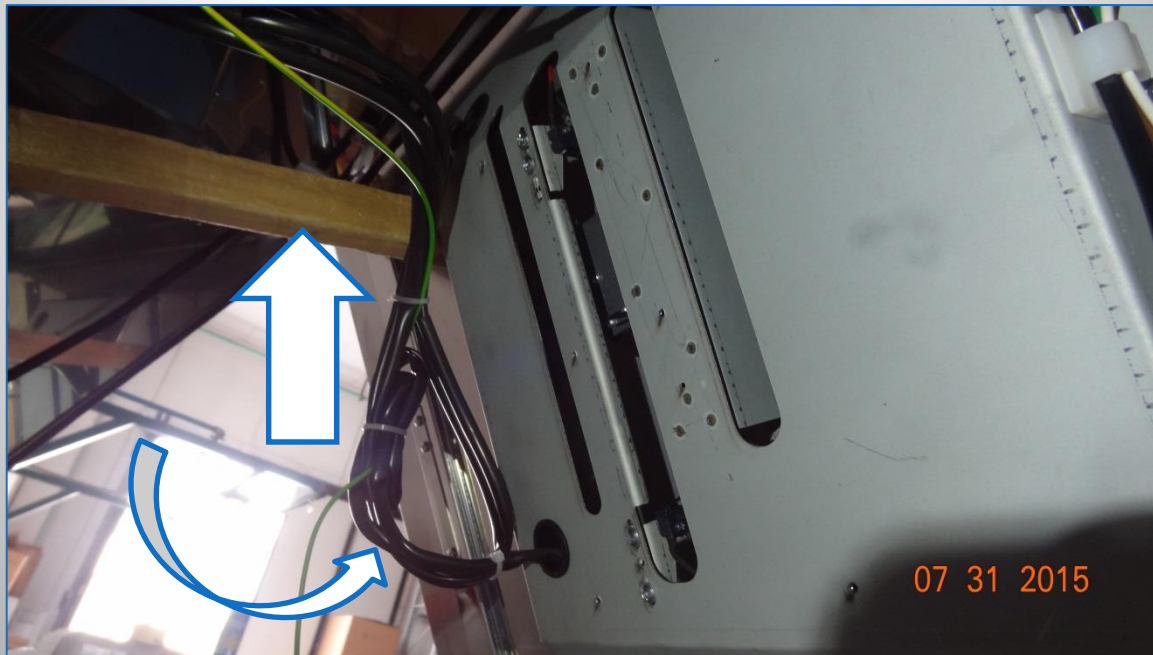

The hood doesn't work and the lights turn on

c. Remove the metal cover removing the 6 screws.

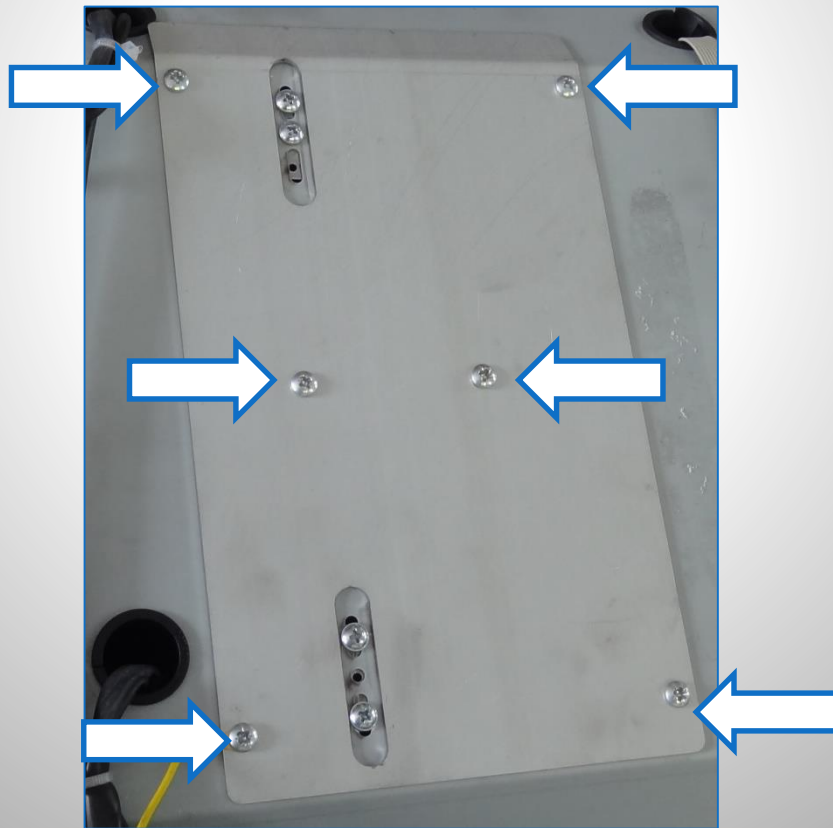

The hood doesn't work but the light turns on

d. Disconnect the net, the 9 poles connection, the encoder connection and only for SLTR, also the flat on the display.

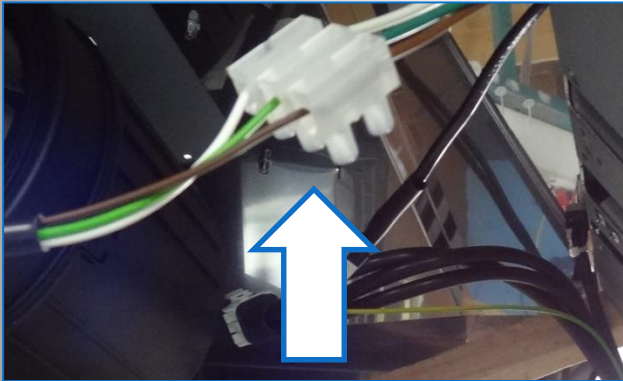

Solo SLTR

The hood doesn't work but the light turns on

e. Remove the six screws fixing the actuator holder

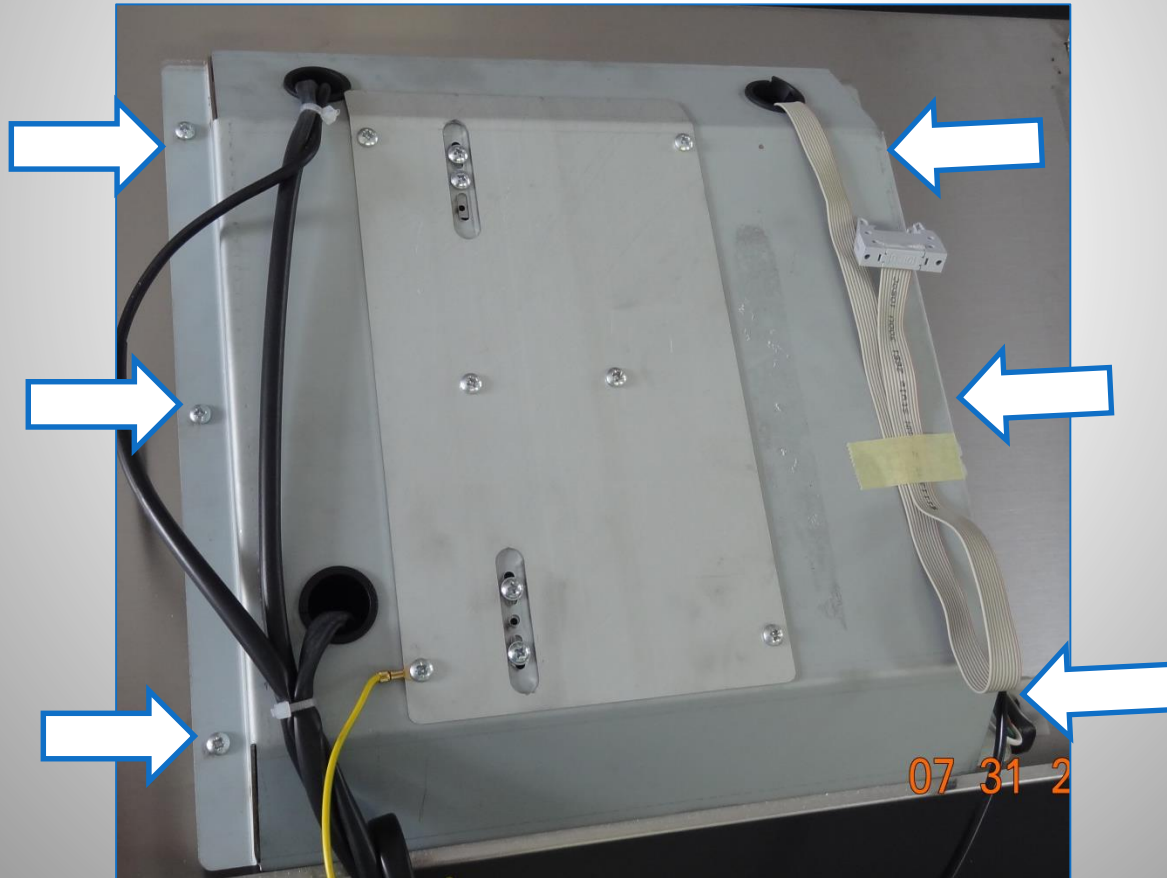

The hood doesn't work but the light turns on

f. Through the two slots, remove the two M4 screws fixing the glass support

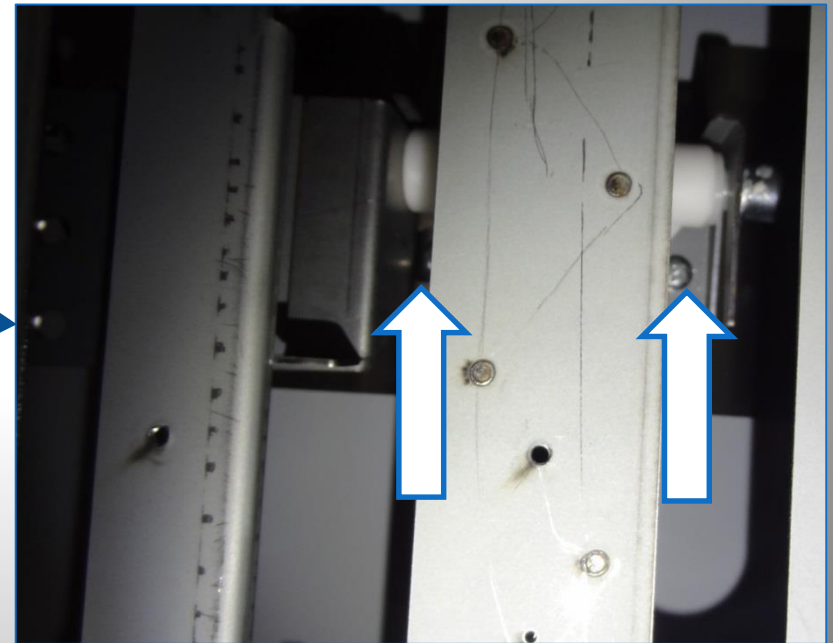

The hood doesn't work but the light turns on

g. Remove the actuator holder



The hood doesn't work but the light turns on

h. Remove the actuator holder.

Attention: regarding SLTR it is necessary to remove the flat cable of the pulling it out from the cable gland.



The hood doesn't work but the light turns on

- i. Remove the bracket holding the micro switch.

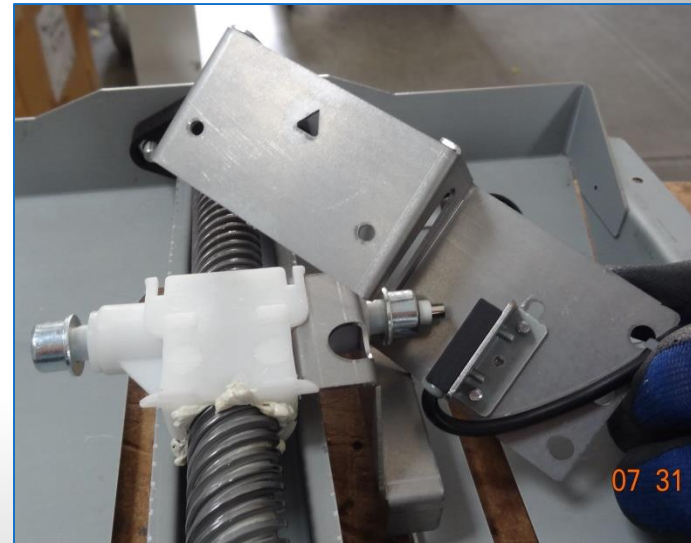
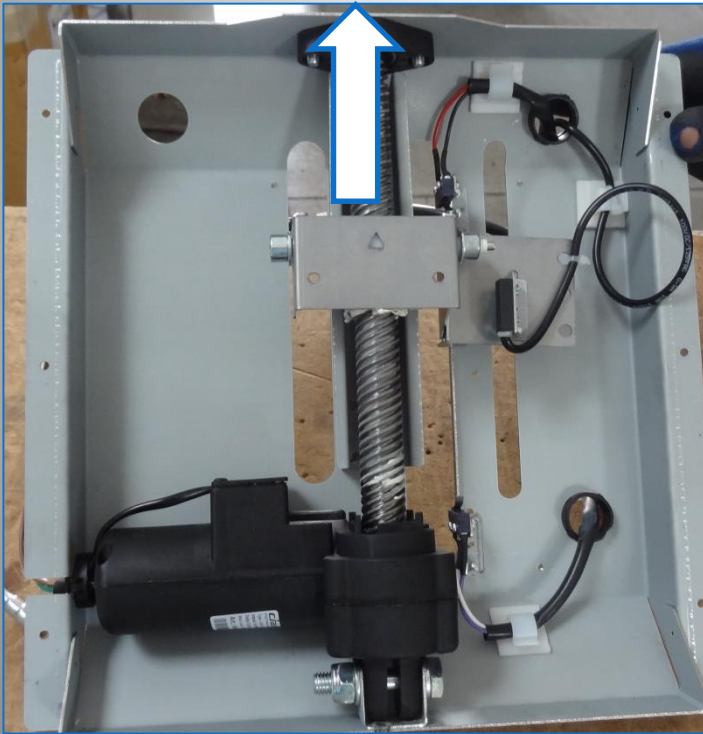

The hood doesn't work but the light turns on

1. Using two wrenches 17mm large and an allen wrench 5mm large, unscrew the two allen wrenches on the upper part.



The hood doesn't work but the light turns on

n. Remove the actuator and replace it with a new one.



Anti-crushing sensor doesn't work

20 Test the security circuit

- a. Control that the cable with the yellow and grey wires is rightly connected to the 9 poles plug and socket connector and to the board. In order to do that fit the tip of the tester together with CN115 connector, consequently open the glass manually. When the magnet on the glass meets the sensor, the circuit should open. If it doesn't open, it is necessary to replace the sensor.

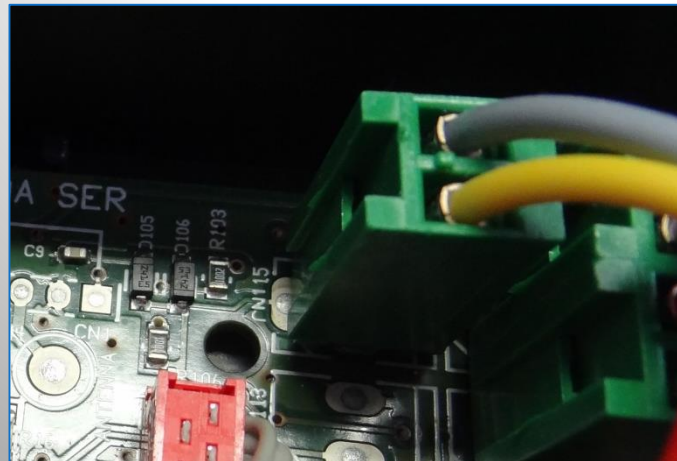

b. In order to replace the security micro switch, it is necessary to remove the actuator (See chap.15), than remove the bracket holding the micro.

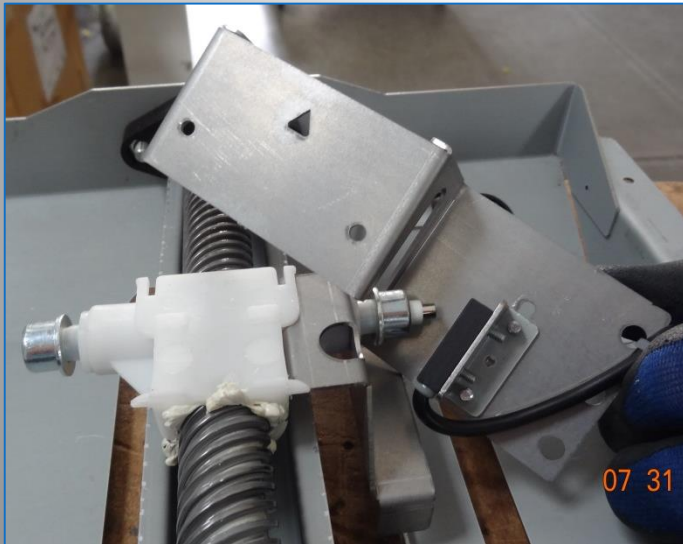

c. Remove the two screws on the back of the bracket



d. Unscrew the screws holding the micro switch, cut the wire and replace the micro welding the wires again



The hood works and the display is off (only for SLTR)

21. *DISPLAY REPLACEMENT*

a. Remove the stainless steel cover removing the three screws

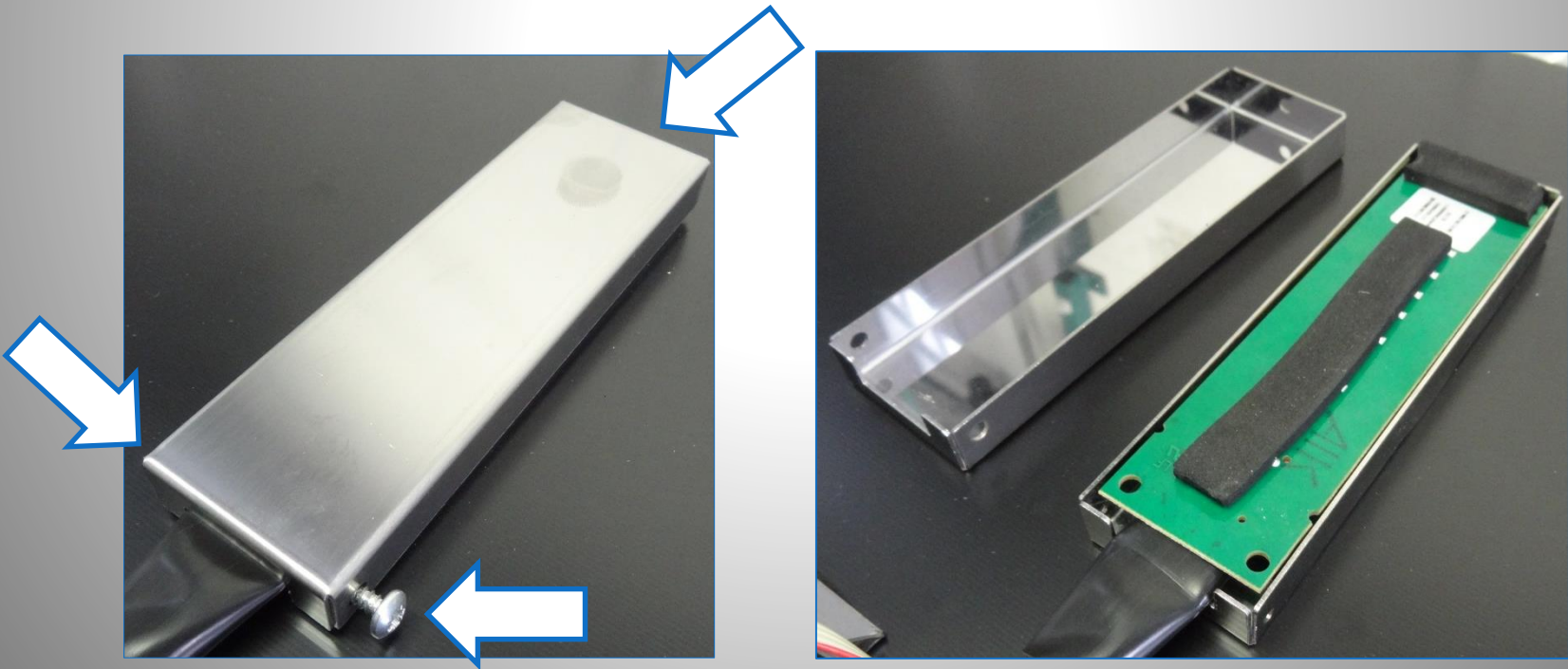

The hood doesn't work and the display is off (only for SLTR)

b. Remove the upper wiring board and disconnect the flat cable

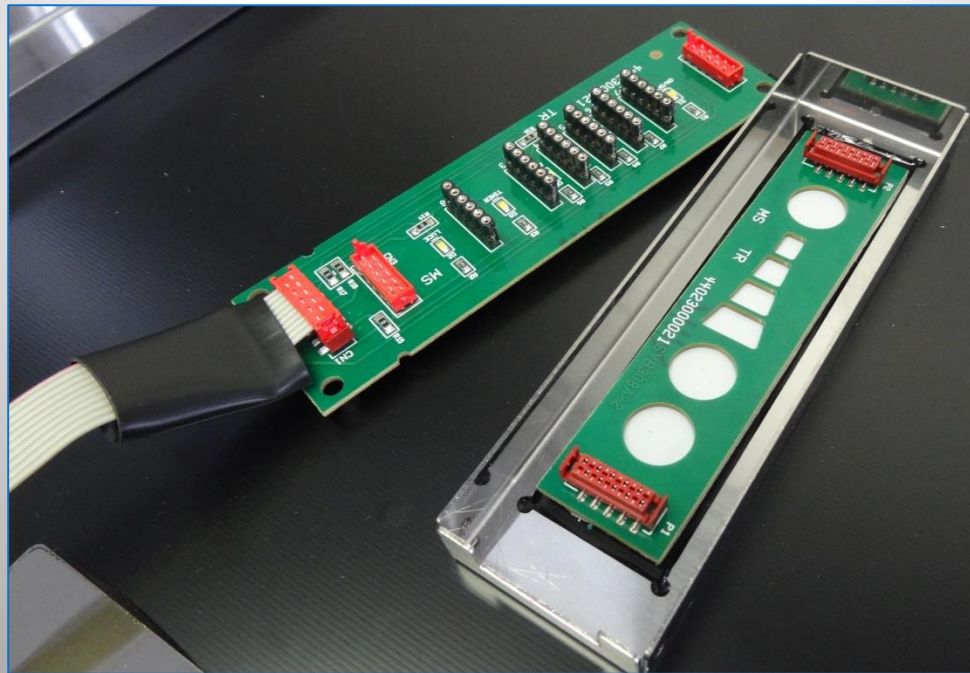

The hood doesn't work and the display is off (only for SLTR)

c. Disconnect the control board from the glass (if necessary use a phon in order to soften the glue and easily detach the board)

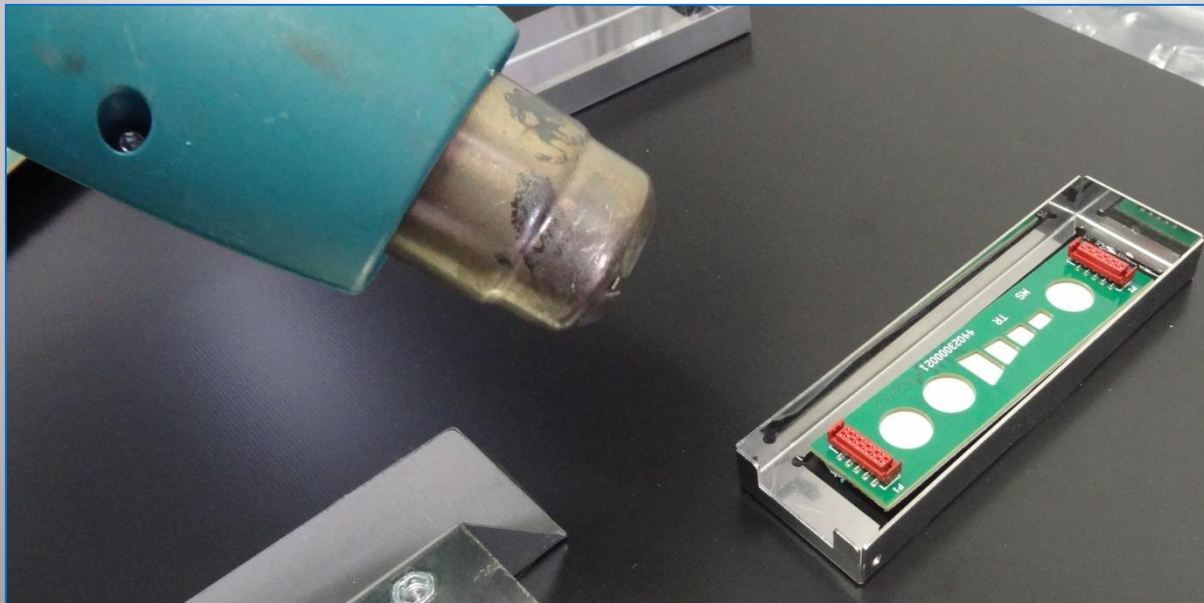

The hood doesn't work and the display is off (only for SLTR)

d. Place the new board paying attention to center perfectly the symbols on the board with the symbols on the glass. **If the problem persists replace the Flat Cable.**

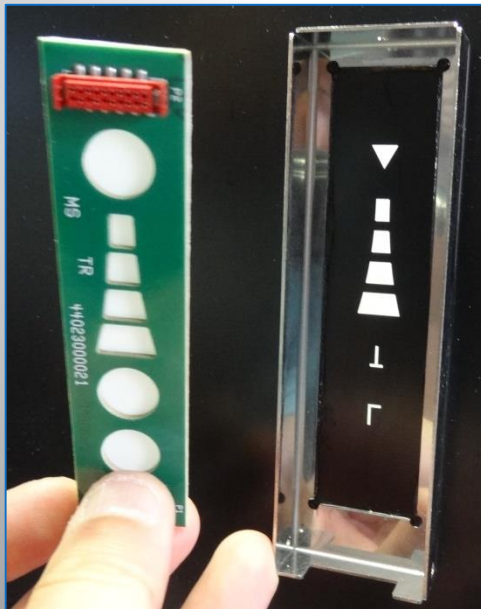

The hood goes up to 4/5 cm than it goes down again

22. *VERIFY IF THE ENCODER IS WORKING*

- a. Verify if the wires of the encoder are rightly connected (BROWN-GREEN-WHITE) both on the connector and on the wiring board.

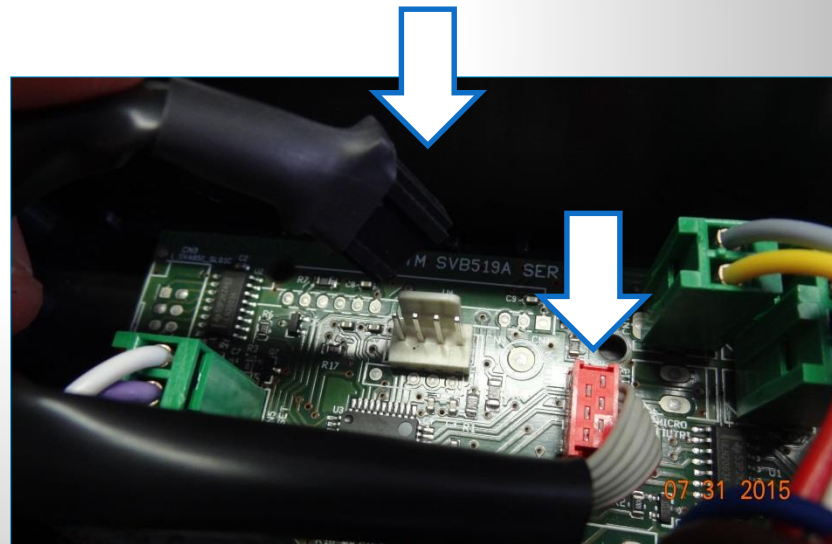
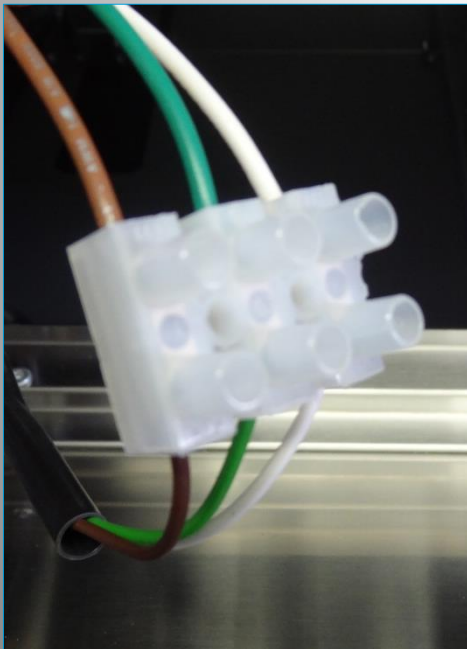

The hood goes up to 4/5 cm than it goes down again

b. In case of SLTR verify if the encoder is connected to the rotary button wiring board,



c. If the problem persists replace the actuator (See chap. 17)

THE LIGHT DOESN'T TURN ON

23. VERIFY THAT THE LED BAR IS WORKING

- a. Unscrew the two screws on the lower side of the hood in order to remove the panel.



THE LIGHT DOESN'T TURN ON

b. Disconnect the connector and check if there is 12 Vcc. Power when you turn the light on.

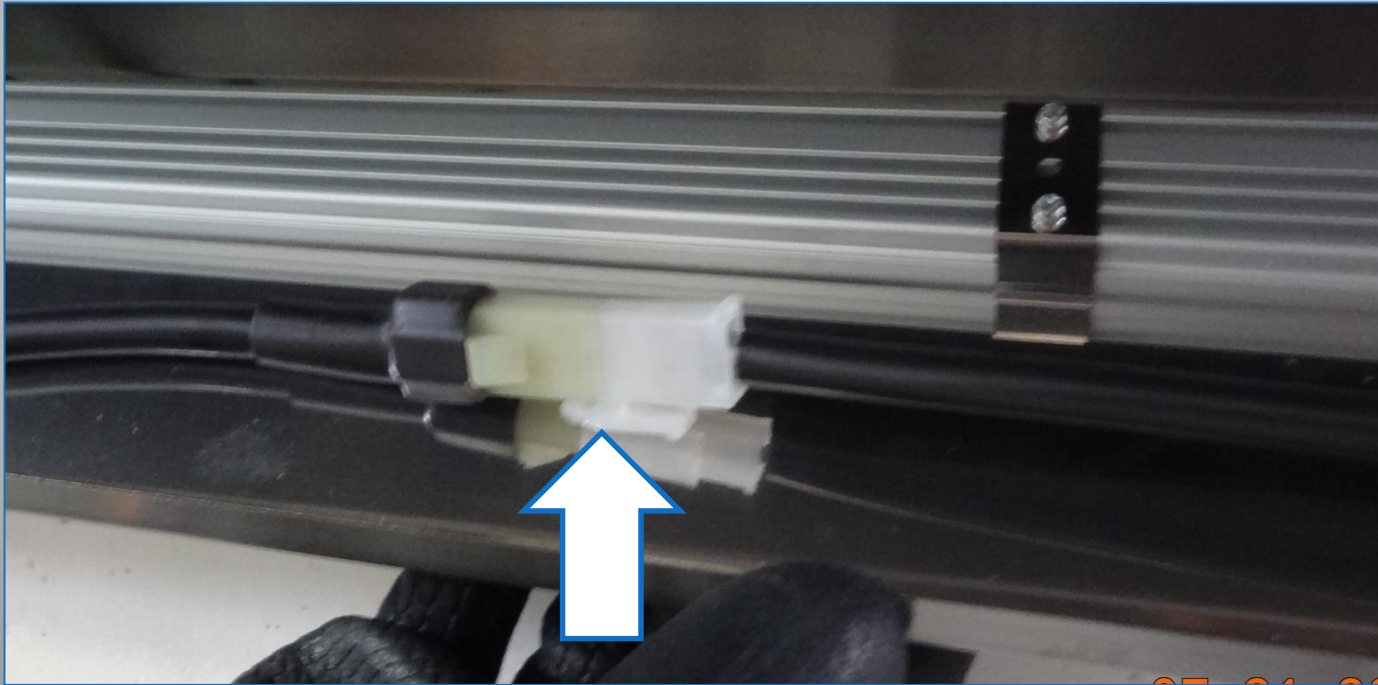

THE LIGHT DOESN'T TURN ON

24. REPLACE THE BALLAST

- a. If the transformer's output voltage is 12V, replace the LED bar pushing it outward and replace it with another one that is perfectly interchangeable

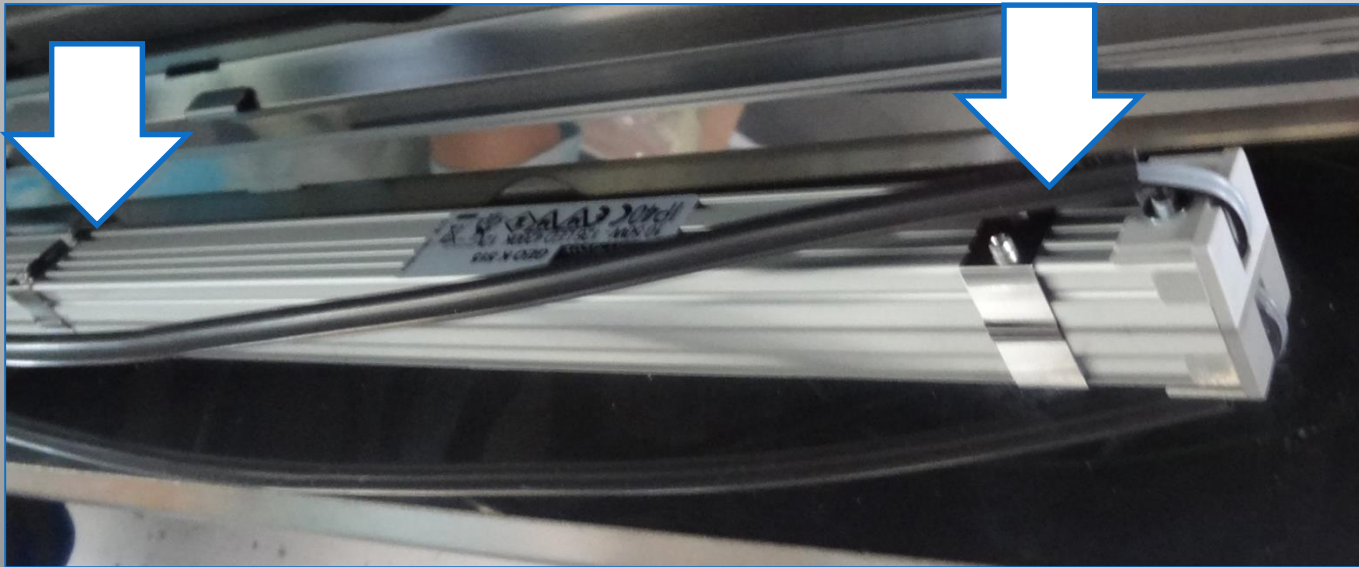

THE LIGHT DOESN'T TURN ON

- b. If the transformer's output voltage is not 12V, replace the transformer of the LED bar. Remove the electrical support equipment as shown on chapter 10.
- c. Remove the two covers of the transformer and disconnect the cables of the led transformer.



220Vac

12Vcc



THE LIGHT DOESN'T WORK

d. Remove the screws fastening the transformer and replace it with a new one.

