



DD520BK

Downdraft 52cm hood black glass



Technical information



DD520BK

Downdraft 52cm hood black glass

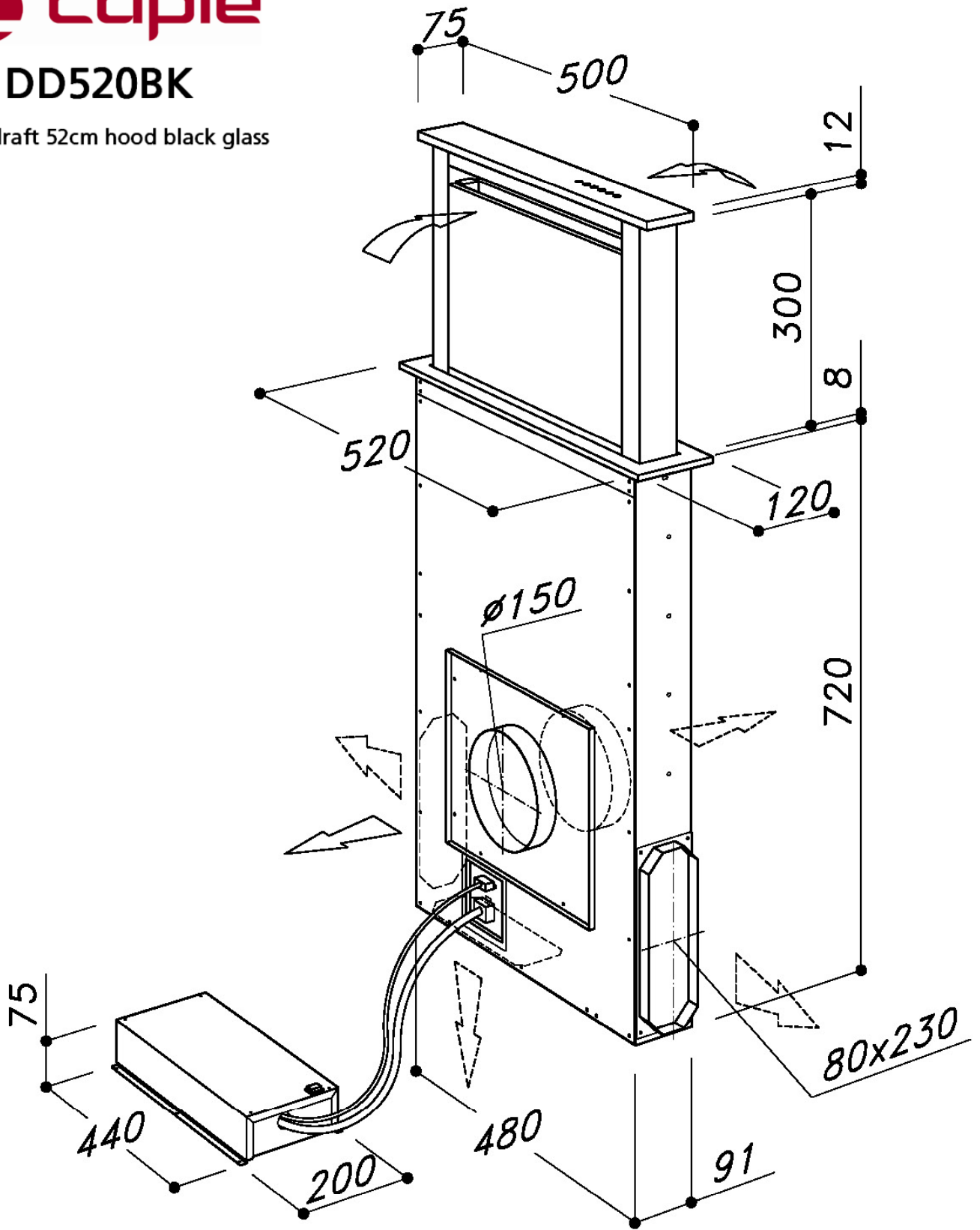

DD520BK

Downdraft 52cm hood black glass

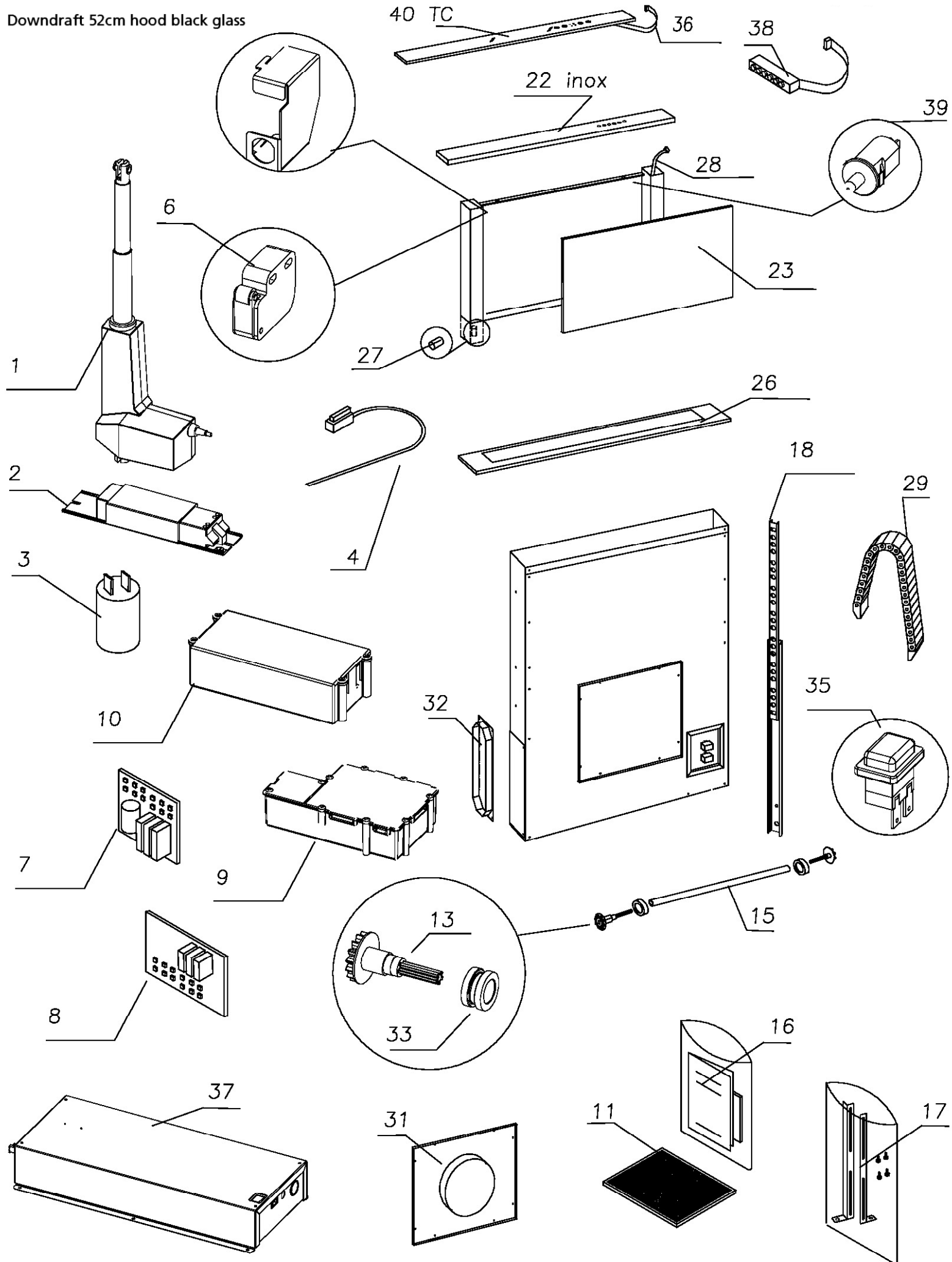



DD520BK - Downdraft hood S.Steel

Item	Part Code	Description	Qty
1	75072099999	ASS. R. ATTUATORE LA31 300mm SDD2	1
2	42030999999	TRASFORMATORE 220/230V 50HZ 50 W	1
3	42041999999	CONDENSATORE 5 MICROF.	1
4	63504000312	SENSORE MAGNETICO L520 (04000312.B)	1
6	60182204081	CRICCHETTO DOPPIA SPINTA NIKEL TRASPARENTE (Before Mar-14)	1
7	44001599999	BASSETTA IMPIANTO EL. S-DD1 ALIMENT.	1
8	44002499999	BASSETTA IMPIANTO EL. S-DD2 PRINCIP.	1
9	75071439999	ASS. R. SCAT. I.E.	1
10	75072600100	ASS. R. SCAT. I.E. S-DD2 V2 PK22	1
11a	75071500212	ASS. R. FILTRO S-DD3 S-DD2 52 (Before Mar-14)	1
11b	75071500020	ASS. R. FILTRO S-DD2 60 LFI-B020 (From Mar-14)	1
13	60180030400	RUOTA DENTATA S-DD1	1
15	60180030153	ASTA RUOTE DENTATE S-DD2 52 MCS-N153	1
16	90002020422	LIBR. ISTR. S-DD3 CAPLE	1
17	77002002999	A.S.A. S-DD2-EM	1
18	60181734380	GUIDA TIPO KA1730/380 M4	1
23a	75021001038	ASS. R. PANNELLO SDD3 52 XS304 (Before Mar-14)	1
23b	75021601013	ASS. R. PANNELLO SDD2 60 CAL XS304 (From Mar-14)	1
26	75023011321	ASS. R. BORDO CARCASSA SDD3 SQUAD.	1
27	63504000314	UNITA' MAGNETICA D4X10 MNDIAM004010T	1
28	44023899999	CAVO PIATTINA PULSANTIERA L=2000 EFI-A238	1
29	75074516018	ASS. R. CATENARIA S-DD2	1
31	75021001097	ASS. R. RACCORDO ARIA ANT. S-DD2	1
32	75021002083	ASS. R. ATTACCO TUBO SDD2 LAT.-INF.	1
33	51501000015	BOCCOLA ASTA OTTONE S-DD1 MCS-N015	1
35	75470199999	ASS. R. TASTO DI EMER/ACC. NEON	1
36	44027999999	CAVO PIATT. M/F DISPLAY TD EFI-A120 (From Mar-14)	1
37	75072000999	ASS. R. CABL. S-DD2 EM TC S.E. ECB-A366	1
38	77000130020	ASS. SCAT. PULSANT. SDD2 (Before Mar-14)	1
39	63504000315	PULSANTE 6A 250V RL52-G-BK-P8-L1-L	1
40	75021203422	ASS. R. FRONTALE PULS. TC S-DD3 52 CAPLE	1
41	75036099999	ASS. R. DUE CREMAGLIERE DD PDI-A036	1
42	60041092553	MAGNETE 20X3 C/FORO SVASATO (From Mar-14)	1
43	75025710150	ASS. R. COPERTURA CALAMITE E MICRO SDD3 (From Mar-14)	1

FOR SEM2 - SEM7 EXTERNAL MOTOR

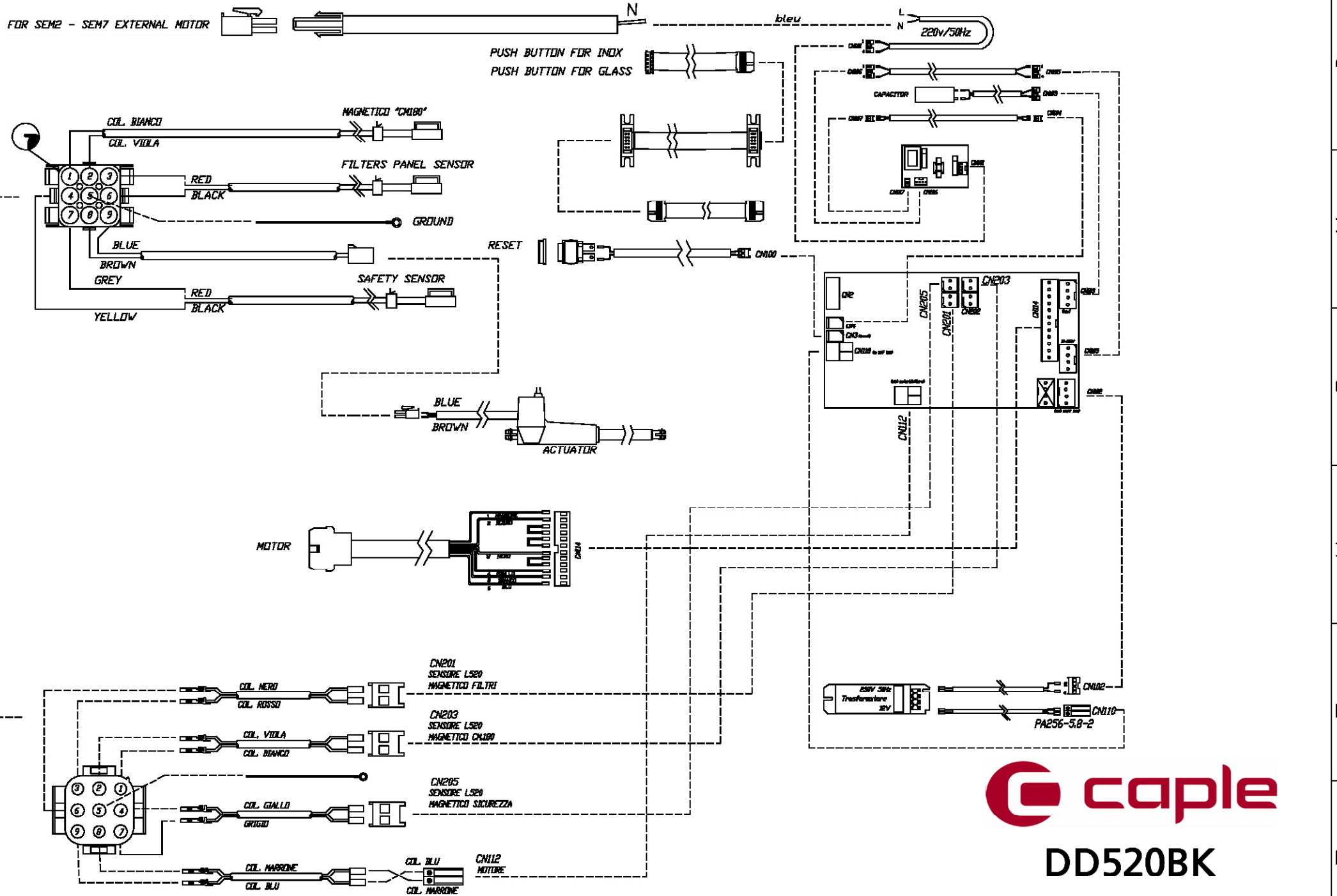

DD520BK

Downdraft 52cm hood black glass



DD600BK
DD600SS
DD605BK
DD605SS
DD900BK
DD900SS
DD910BK
DD910SS
DD910WH

Trouble shooting

PROBLEM

THE DOWNDRAFT EXTRACTABLE UNIT DOES NOT OPEN, THE SUCTIONING SYSTEM DOES NOT WORK AND THE PUSH-BUTTON PANEL IS OFF.

POSSIBLE SOLUTIONS

- Check if the network voltage is working
- Check if the red power button is in on position
- Check if the male and female connections in the 9 pole connector are connected properly
- Check if the circuit of the grease filters panel presence is closed
- Check if the grease filters cover panel is disengaged
- Check if the grease filter panel presence keys are working properly
- Check integrity of the grease filters panel presence residual circuit
- Replace the main electrical system board
- Replace the power supply system board
- Check the connection of the push-button panel connector
- Replace the upper front panel

PROBLEM

THE EXTRACTABLE UNIT OPENS BUT THE SUCTIONING UNIT DOES NOT WORK AT ANY SPEED

- Check if the 6 pole connector of the suctioning unit cable is connected properly to the wiring and if all the connector pins are properly inserted into the connector itself.

- Check if the suctioning unit 6 pole connector wires in the main electrical system board are connected properly and if all the green connector pins are properly inserted inside the board.
- Only with on-board motor Check if the suctioning unit 6 pole connector is connected properly and if all the connector pins are properly inserted inside the connector itself
- Check if the relays inside the board switch over properly with pressure of speed change from the push-button.
- Replace the main electrical system board
- Replace the suctioning unit

PROBLEM

THE BODY LINER IS DAMAGED

POSSIBLE SOLUTIONS

- Replace the body liner

PROBLEM

THE SUCTIONING SYSTEM WORKS PROPERLY BUT THE EXTRACTABLE UNIT DOES NOT OPEN

POSSIBLE SOLUTIONS

- Check if the electrical system connectors are connected properly .
- Check the actuator inside connection
- Check if the electro-mechanical transformer placed inside the electrical system box is working properly
- Replace the actuator.

PROBLEM

THE EXTRACTABLE UNIT RE-OPENS BY ITSELF DURING AND AFTER ITS CLOSING

POSSIBLE SOLUTIONS

- Check if the safety sensor is working properly
- Carry out the calibration reset
- Make the calibration Replace the push-button front panel
- Replace the main electrical system board

PROBLEM

THE PUSH-BUTTON PANEL DOES NOT LIGHT UP

POSSIBLE SOLUTIONS

- Check if the push-button connector is connected properly
- Replace the push-button panel
- Replace the main electrical system board

PROBLEM

- **LIGHTING DOES NOT LIGHT UP (ONLY FOR SDD2-L)**

- Replace the neon tube
- Check if the neon supports are not damaged and are connected properly.
- Replace the neon tube supports
- Check if the ballast input voltage is 230V
- Replace the ballast.

PROBLEM

THE FILTERS ALARM SIGNAL AFTER 30 HOURS WORKING DOES NOT RESET WHEN PRESSING THE TIMER KEY

POSSIBLE SOLUTIONS

- Disconnect and restore power supply
- Replace the push-button front panel.
- Replace the main electrical system board.

PROBLEM

THE DOWNDRAFT AIR -CAPACITY IS INADEQUATE

- Check the suction duct length
- Check the air outlet pipe section
- Make sure there are no obstructions along the pipe
- Check if the charcoal filters are still in good conditions in case of Filtering version

- Check efficiency of all speeds in the suctioning unit .
- Check if the non-return valve tongues can move freely

PROBLEMA RISCONTRATO

**THE EXTRACTABLE UNIT OPENS, BUT IT DOES NOT STOP WHEN REQUIRED, AFTER 180 mm, AND THE SUCTIONING SYSTEM WORKS WHEN THE EXTRACTABLE UNIT IS COMPLETELY OPEN, AND STOPS WHEN THE EXTRACTABLE UNIT IS COMPLETELY CLOSED.
(ONLY FOR SDD2)**

- Check if the 180mm sensor is working properly.
- Replace the 180mm sensor

PROBLEMA RISCONTRATO

1. THE DOWNDRAFT EXTRACTABLE UNIT DOES NOT OPEN, THE SUCTIONING SYSTEM DOES NOT WORK AND THE PUSH-BUTTON PANEL IS OFF.

POSSIBLE SOLUTION

CHECK IF THE NETWORK VOLTAGE IS WORKING.

Make sure the magnetic circuit breaker (life-saving switch) has not tripped and the system protection fuses are in good conditions. In this case you need to call a specialized technician in order to fix the problem.

CHECK IF THE RED POWER BUTTON IS IN ON POSITION

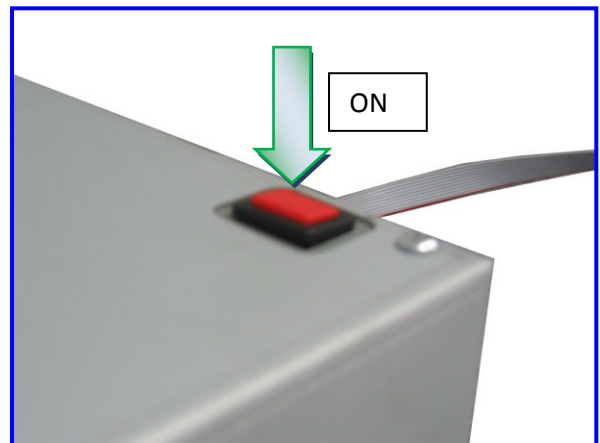
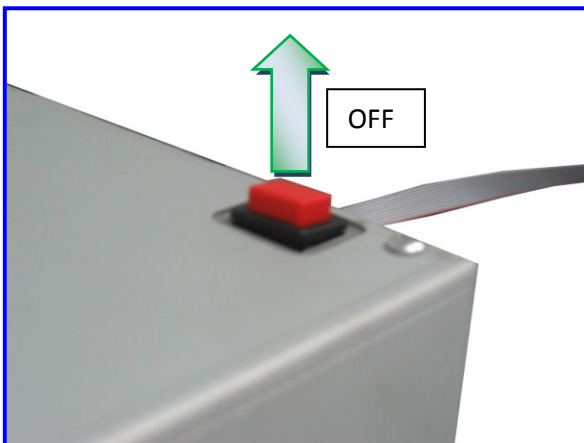

CHECK IF THE MALE AND FEMALE CONNECTIONS IN THE 9 POLE CONNECTOR ARE CONNECTED PROPERLY

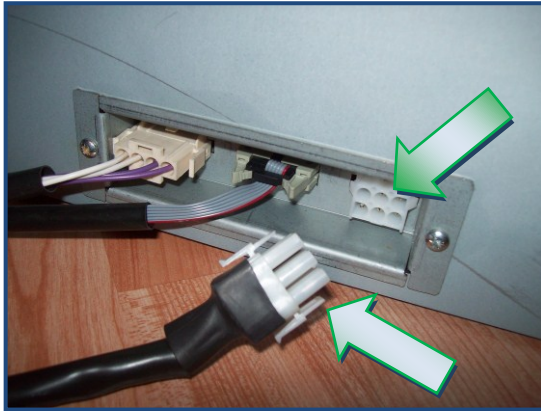

ATT: NEI MODELLI SDD2 E SDD2L I CONNETTORI NON SONO DISPOSTI NELLO STESSO MODO INOLTRE NEL MODELLO SDD2-L NON E' PRESENTE IL CONNETTORE DI RETE.

- Disconnect power supply by pressing the red button placed in the electrical system box

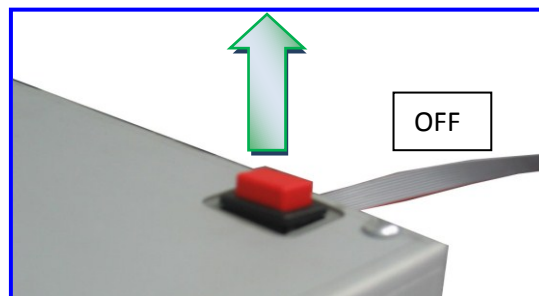

- Release the movable connector wires by removing the black sheath.

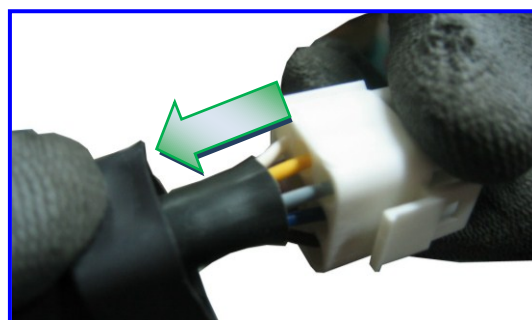

- Check if the connector inner contacts are inserted properly, by using a screwdriver. Carry out this check in both the fixed and the movable connectors.

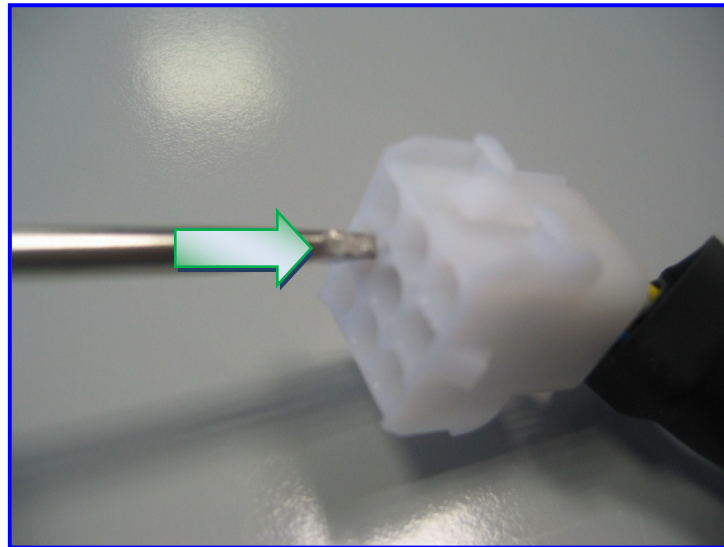

- Nel connettore a 9 poli sono presenti 7 fili nel modello SDD2-L mentre 9 fili nel modello SDD2 (dato che in questo modello è presente il sensore dei 180mm) e precisamente:

Grease filters panel presence buttons

- PIN 3 RED COLOUR
- PIN 6 BLACK COLOUR

Magnetic safety circuit breaker

- PIN 4 YELLOW COLOUR
- PIN 7 GREY COLOUR

Actuator

- PIN 9 BROWN COLOUR
- PIN 8 BLUE COLOUR

Ground connection

- PIN 5 yellow/green

seniore magnetico Cm. 180 (solo per SDD2)

- PIN 2 Colore viola
- PIN 1 Colore bianco

• **Schemi elettrici**

SDD2-L

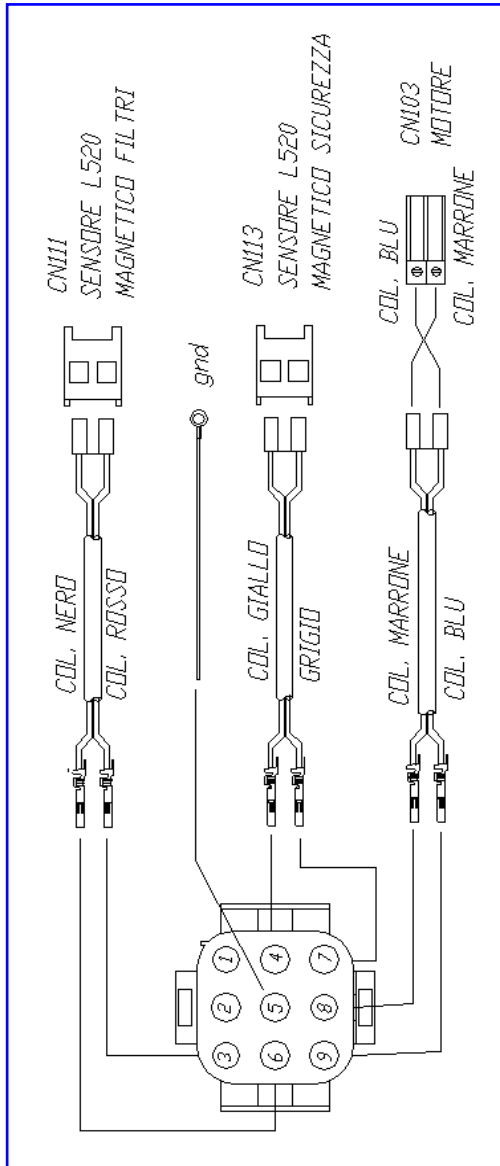

SDD2

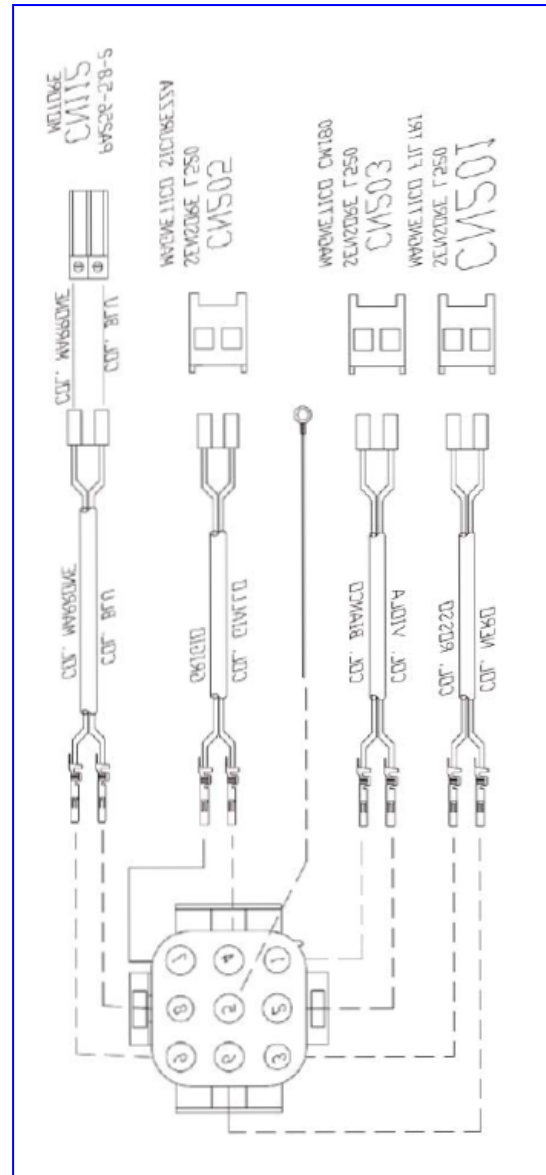

• IMPIANTO ELETTRICO SDD2-L

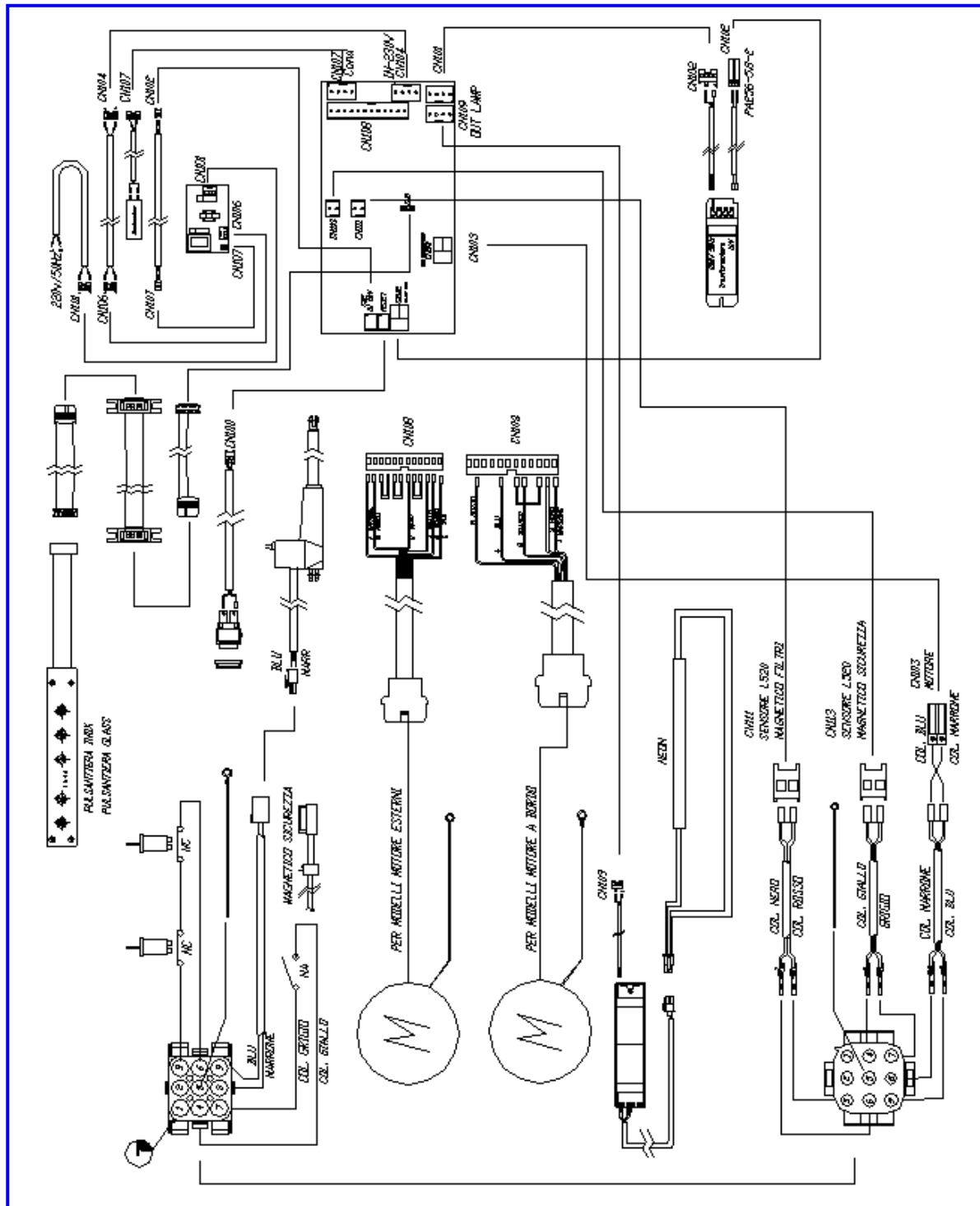

• IMPIANTO ELETTRICO SDD2

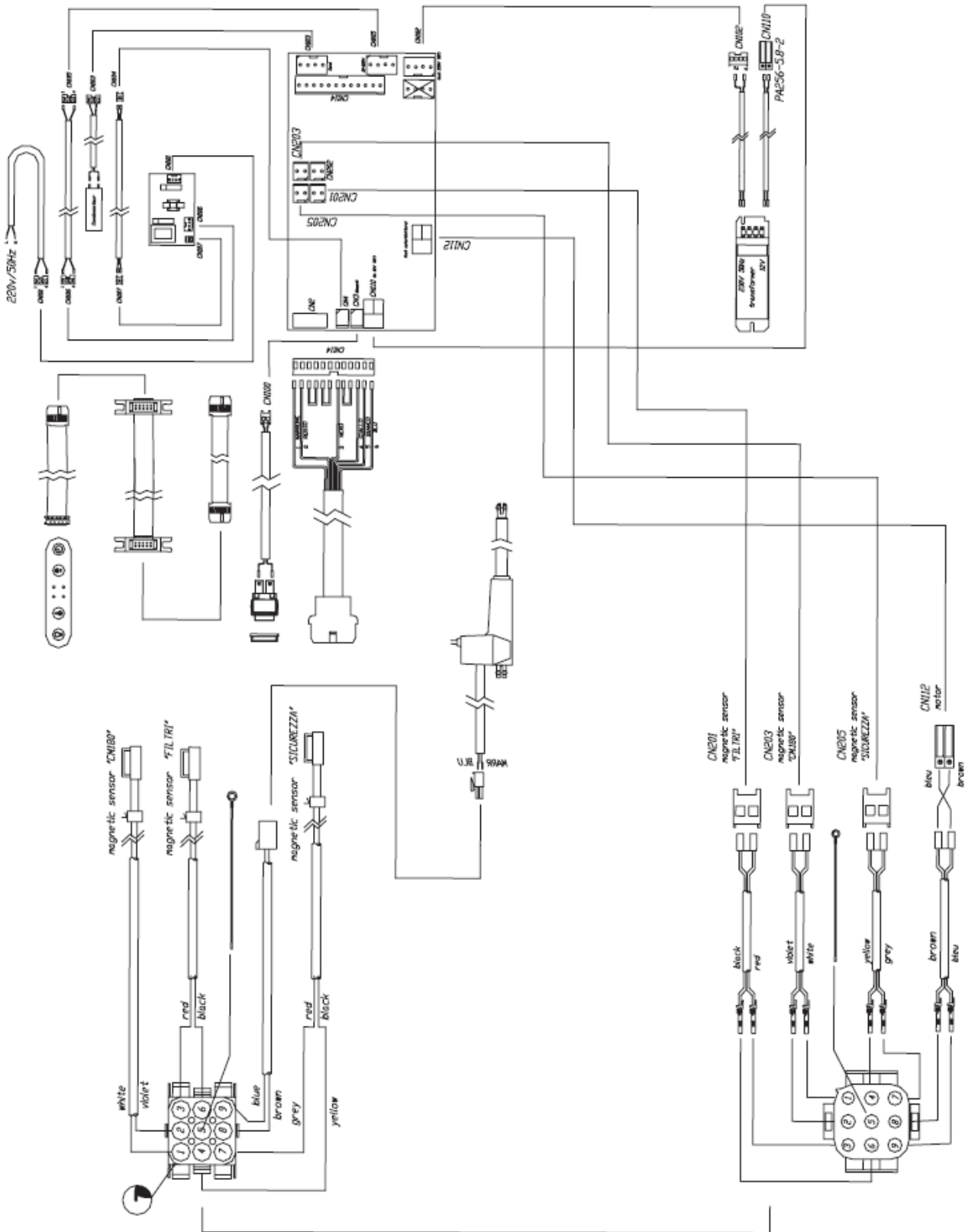

VERIFICARE CHE IL CIRCUITO DELLA PRESENZA PANNELLO FILTRI SIA CHIUSO.

“The downdraft is equipped with buttons, placed behind the grease filters covering panel which, in the case of opening, prevent the downdraft from starting any functions. The cooker-hood is packaged by the manufacturer and the panel is carefully secured with an adhesive tape, in order to prevent it from being disengaged during transport. If the adhesive tape is removed before installation operations are completed , it is likely that the panel will open when the extractable unit is closed , preventing the cooker-hood from proper working.

- Disconnect the 9 pole connector

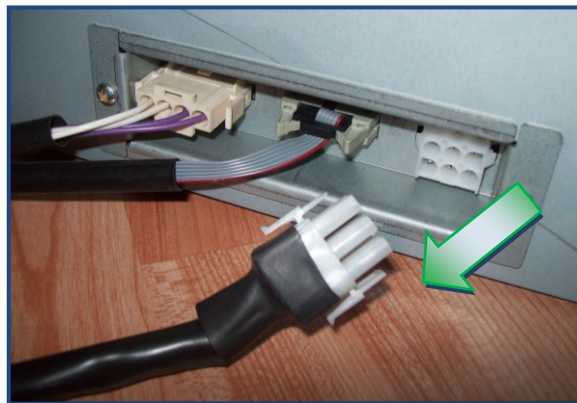

- Set the multimeter in the “ohm” function and place the test prods in the female connector of the downdraft panel into the pins corresponding to the red and black wires of the male connector .

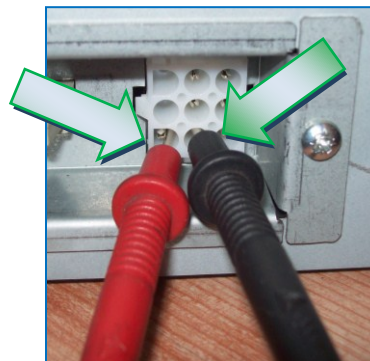
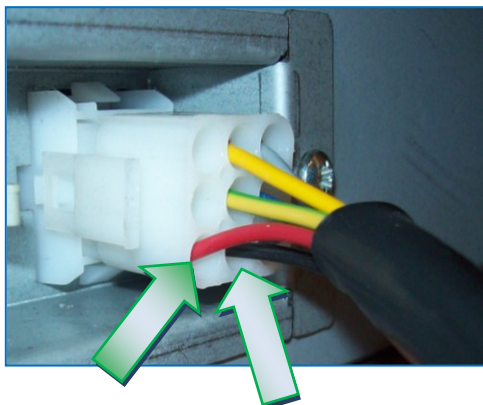

- If the multimeter shows “000” continuity it means that the circuit is closed and the panel is positioned properly.



- If the multimeter shows NO continuity it means that the circuit is open somewhere and the downdraft does not work.



CHECK IF THE PANEL IS UNHOOKED

If the extractable unit is closed and the panel accidentally unhooks , causing the opening of the contact of the filters panel position , it is necessary to hook it again in order to restore operation.

- Disconnect the downdraft from the power supply.

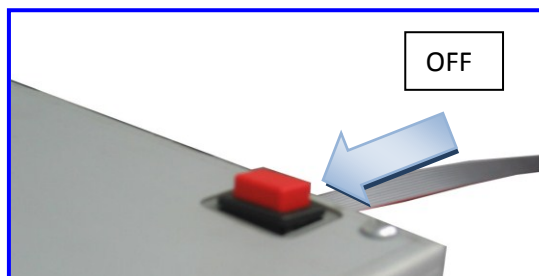

- Scollegare tutti i connettori.

Remove the brackets which fix the downdraft to the cabinet.



- In case of internal motor version, remove the motor fixing screws and remove the suctioning unit.



In case of external motor version (EM) remove the air-outlet flange



- Lift the downdraft up from the cabinet

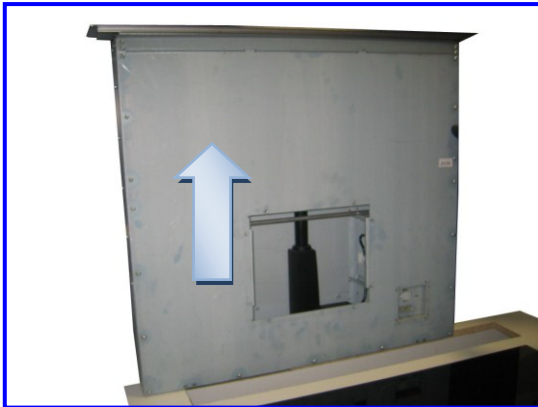

- Remove the front body panel



- Hook it again, by pressing simultaneously on both sides of the panel.

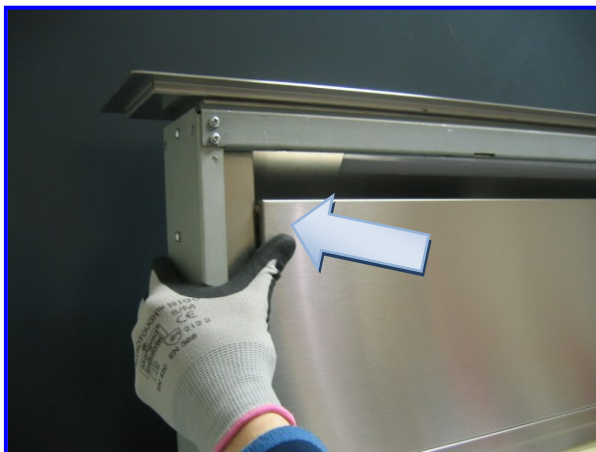

- After having remounted the body front panel , and before placing the downdraft again into the cabinet, we recommend to check the downdraft operation.

CHECK IF THE GREASE FILTER PANEL PRESENCE BUTTONS ARE WORKING PROPERLY

If the panel is securely hooked but the continuity test shows that the circuit is open , you need to check the buttons conditions.

“ The grease filter panel presence buttons are placed in the extractable unit , behind the grease filters panel . You need to lift the extractable unit up to check the buttons conditions and in doing so an electric bridge needs to be made in order to close the circuit .”

CAUTION: BEFORE MAKING THE ELECTRIC BRIDGE AND OPENING THE EXTRACTABLE UNIT, PLEASE MAKE SURE THAT THE PANEL IS HOOKED , OTHERWISE YOU WILL RISK TO DAMAGE THE COOKER-HOOD IRREPARABLY .

Realizzare il ponte elettrico solo se il pannello è ben agganciato e permette lo scorrimento del carrello.

Se il pannello si trova in posizione sganciata tale da non permettere lo scorrimento del carrello NON effettuare il ponte elettrico.

You need to have an electric wire and by-pass (short-circuit) the red and black wires in the male connector in order to make the electric bridge

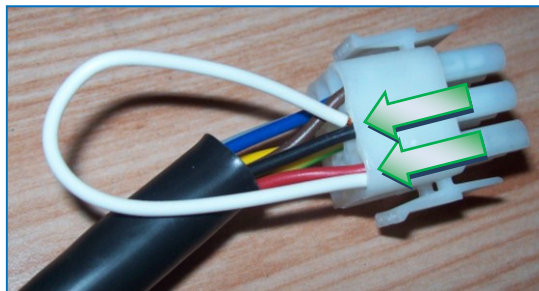

Then connect the connector to the cooker-hood



- Check if the other connectors are inserted properly , the red button is in on position and then push the ON button in the push-button panel.
- Lift the extractable downdraft unit up, by pressing the on/off key

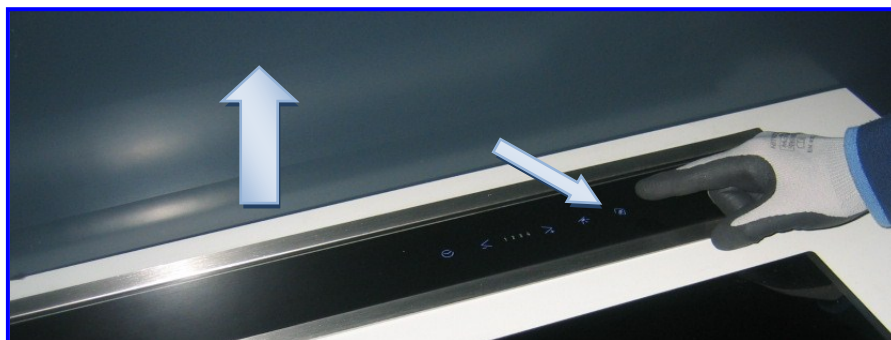

- Remove the grease filters covering panel



- Remove the right and left hinge covers by pulling outwards



By using a multimeter and in the continuity mode, check if the button is working properly

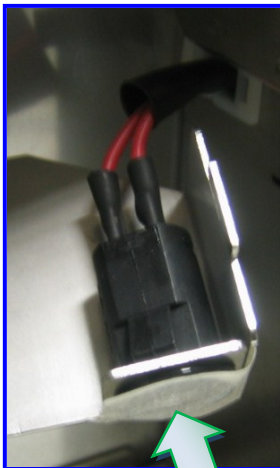

Button
pressed
CONTACT
CLOSED



Button
released
CONTACT
OPEN

CHECK THE INTEGRITY OF THE GREASE FILTERS PANEL PRESENCE RESIDUAL CIRCUIT .

“If the panel is securely hooked, the buttons are working properly , but the continuity test shows that the circuit is open , the other connections of the circuit itself shall be checked. If the continuity test is performed in the female connector placed in the cooker-hood panel and the circuit turns out to be open , it means that the break is inside the cooker-hood, so you need to check the buttons connections and the red and black wires connection in the 9 pole connector. “

Check the buttons connections:

- Lift the extractable unit up by using the electric bridge shown in **PAGINA 18**

-

Togliere il frontale superiore come segue:

Nel modello SDD2-L

Remove the upper front panel by unscrewing the two socket head screws found on the right and left side of the cooker-hood

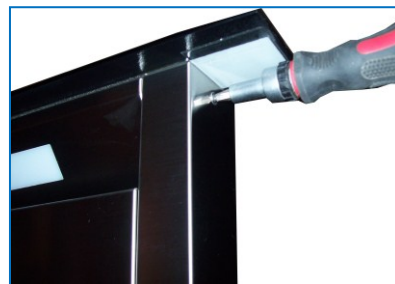

Nel modello SDD2

Remove the 4 screws of the head lower cover and take the covering out by pulling it outwards.



Take the under head 5 screws and the two lateral screws out.



Per entrambi i modelli:

- Lift the front panel up , paying attention to the push button panel flat cable , disconnect the flat connector and remove the front glass panel in order to avoid any possible damage.

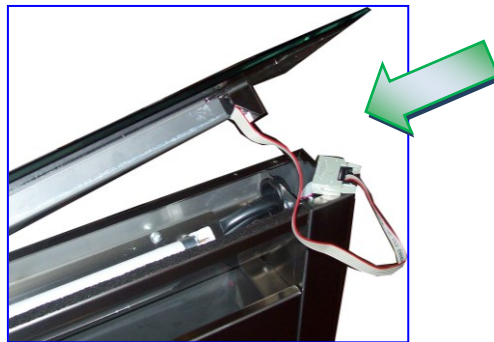

- Check if the buttons connections inside the extractable unit right and left columns are well connected and the red and black wires are inserted properly ..

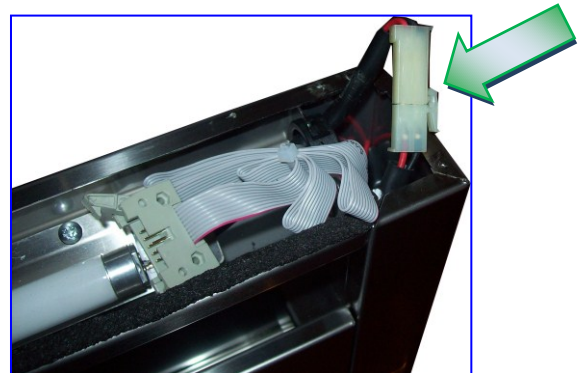
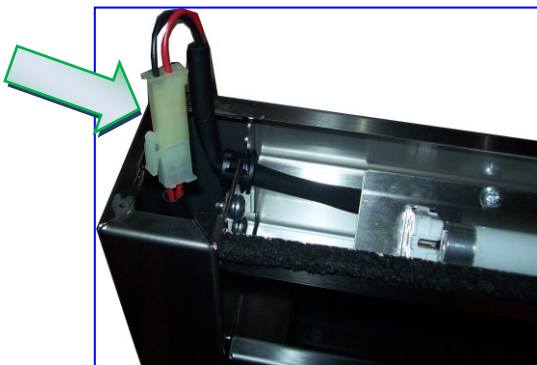

Verificare tutti i fili del connettore a 9 poli e i pin del flat pulsantiera siano integri.

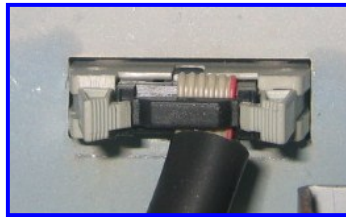

REPLACE THE MAIN ELECTRICAL SYSTEM BOARD

- Remove power supply by disconnecting the plug from the mains or by opening the magneto-thermal switch if present.
- Remove the electric system box cover by unscrewing the 4 screws.

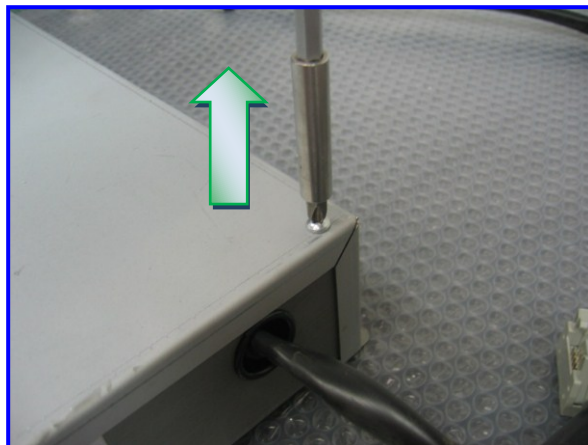

- Find the main board box

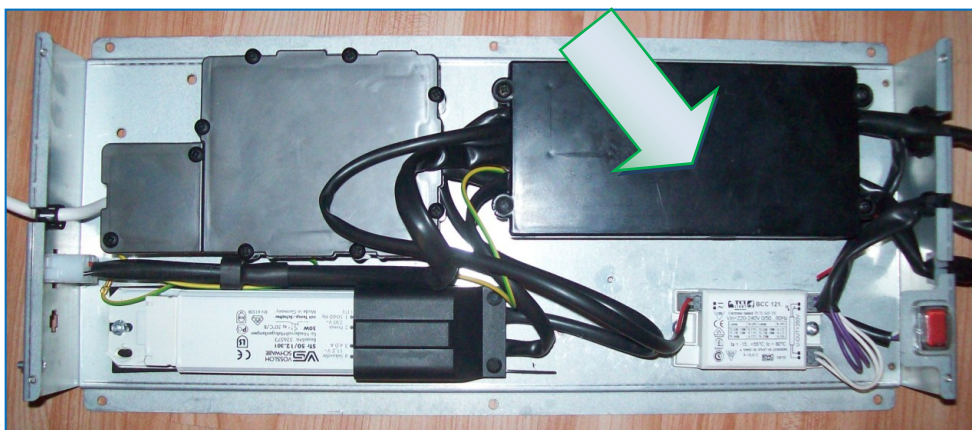

- Remove the 4 screws in the plastic cover.

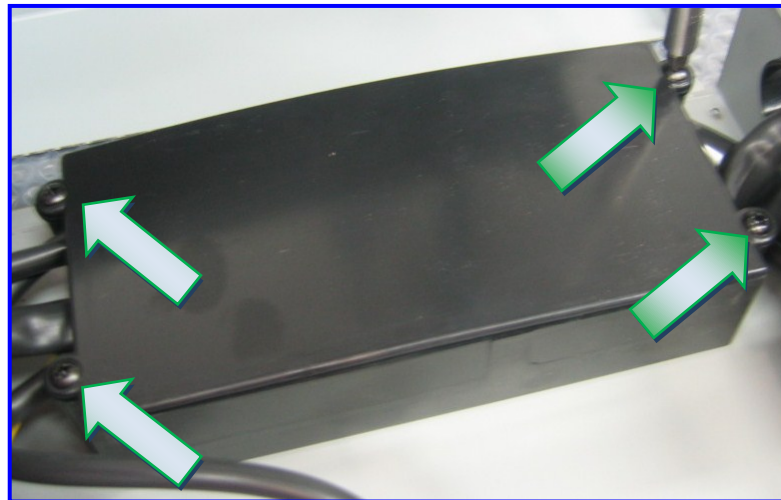

- Remove the fairlead

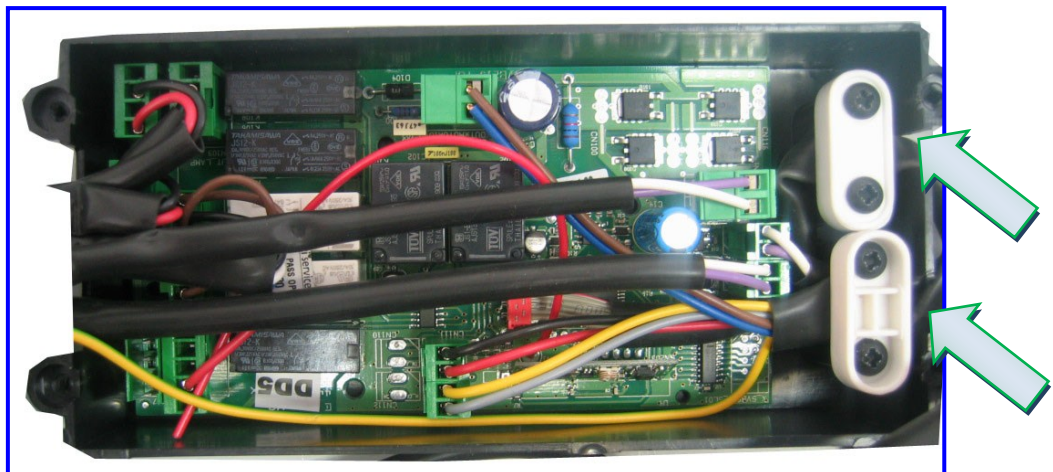

- Disconnect a connector a time **making sure to reconnect them properly** in the new board (use the wiring diagram) **Per il ricambio della scheda utilizzare la lista ricambi del modello in questione.**

CAUTION: PAY ATTENTION TO THE WAY THE CONNECTORS ARE INSERTED

REPLACE THE POWER SUPPLY SYSTEM BOARD

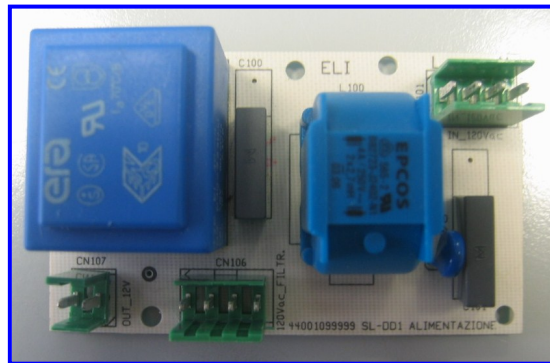

- Remove power supply by disconnecting the plug from the mains or by opening the magneto-thermal switch if present
- Remove the electric system box cover by unscrewing the 4 screws.

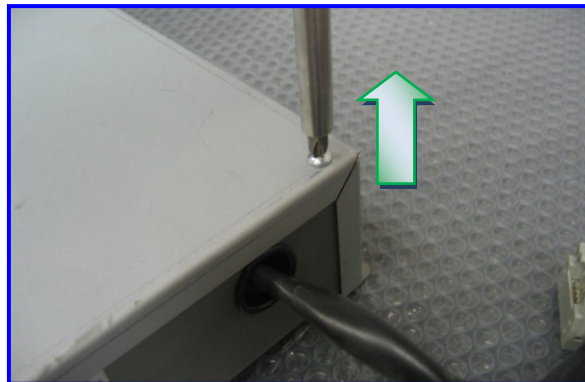

- Find the power supply board box.



- Disconnect a connector a time **making sure to properly reconnect them** in the new board (use the wiring diagram and figures shown below.)

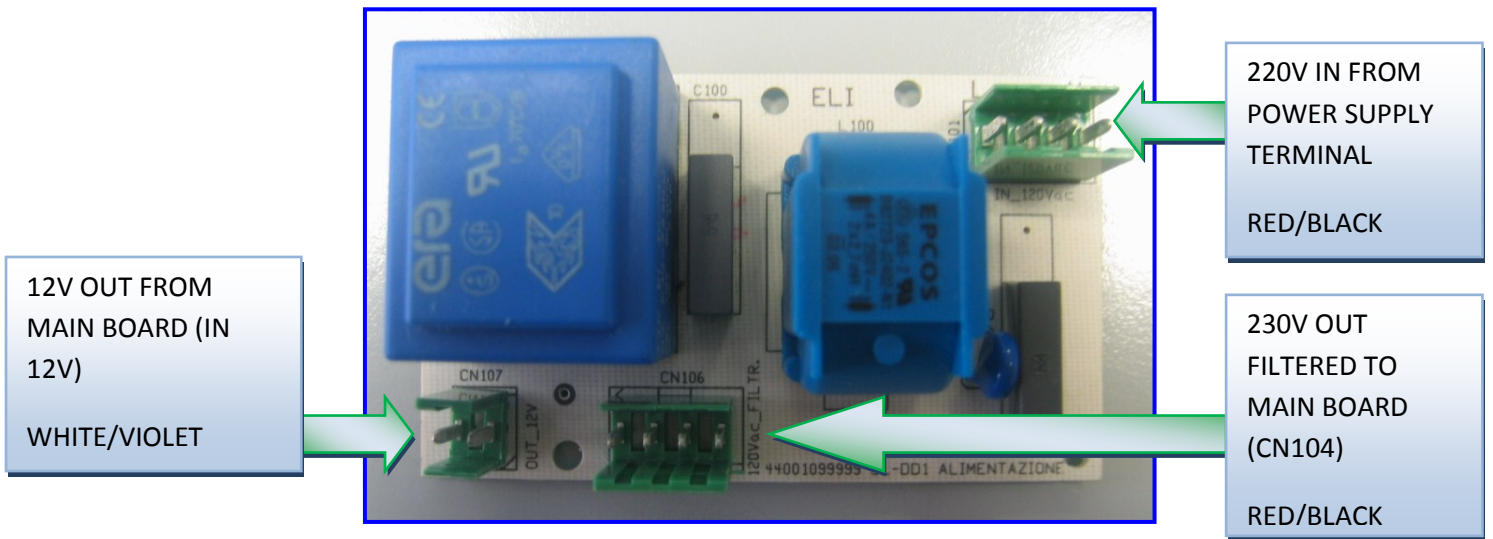

CHECK CONNECTION OF THE PUSH-BUTTON PANEL CONNECTOR

- Check if the grey connector of the push-button panel is inserted properly and if there are any bent pins inside the connector.

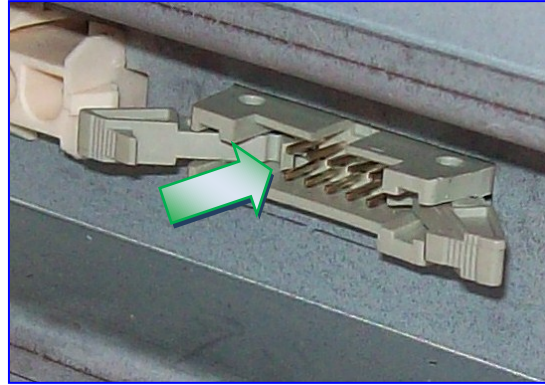
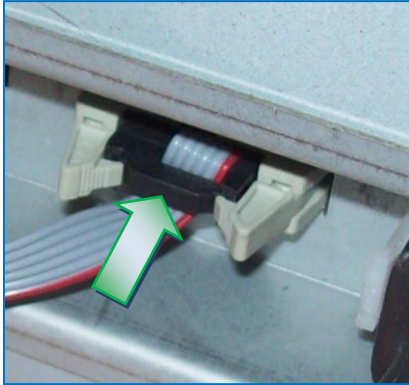

- Check if the push-button panel flat cable is properly connected to the main board.

Collegamento pulsantiera SDD2

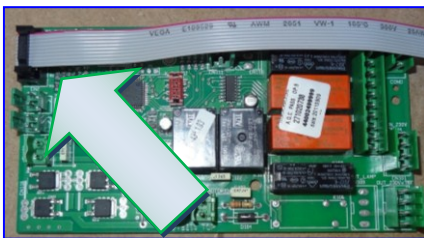

Collegamento pulsantiera SDD2-L

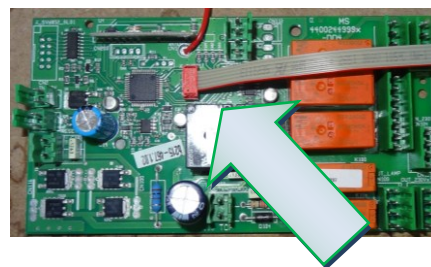

- Check if the flat cable inside the right column of the extractable unit is properly connected to the connector. You need to remove the upper front side to carry out this operation (pag.21)

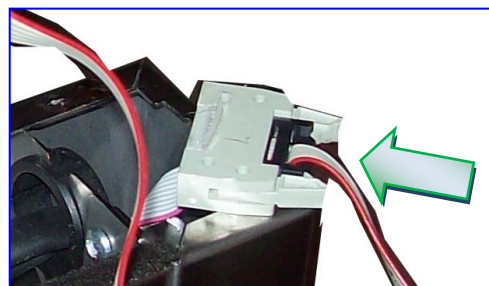
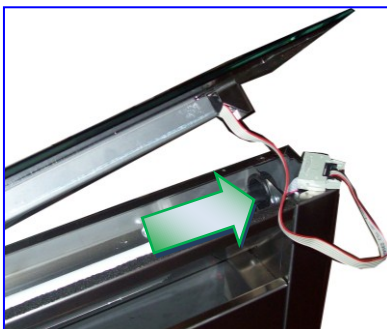

SOSTITUIRE IL FRONTALE SUPERIORE

“Per sostituire il frontale superiore è sufficiente eseguire le operazioni riportate a pagina 17 , rimuovere l'intero frontale e sostituirlo con uno nuovo. Per quanto riguarda i modelli SDD2 con frontale in vetro, la sostituzione del frontale si intende completa di pulsantiera, in quanto incollata al vetro stesso, mentre per i modelli con frontale inox, è possibile sostituire soltanto il frontale.”

PROBLEM

2. THE EXTRACTABLE UNIT OPENS AND CLOSSES, BUT THE SUCTIONING UNIT DOES NOT WORK AT ANY SPEED

POSSIBLE SOLUTION

Check if the 6 pole connector of the suctioning unit cable is connected properly to the wiring and if all the connector pins are properly inserted into the connector itself

- Check if the connector is inserted properly, pull the sheath outwards and make sure the wires are well inserted into the connectors, according to the colours scheme shown in the figure below.

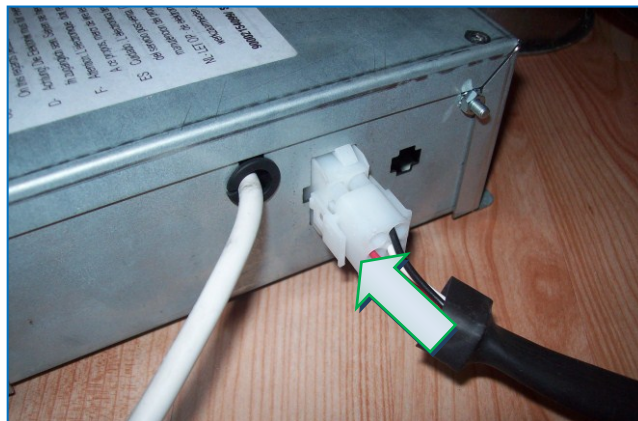

“It may happen that the connector pins , due to overpressure during their insertion, come out of their seat preventing the electric connection from being performed. With the help of a tool , check if the pins are properly connected.”

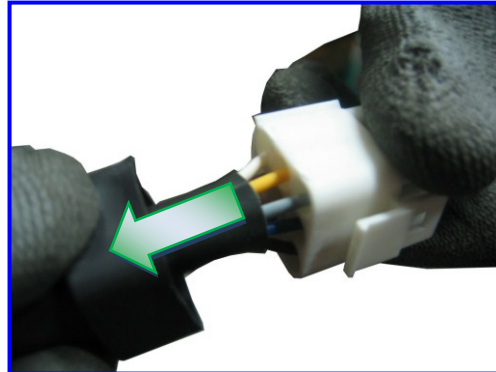
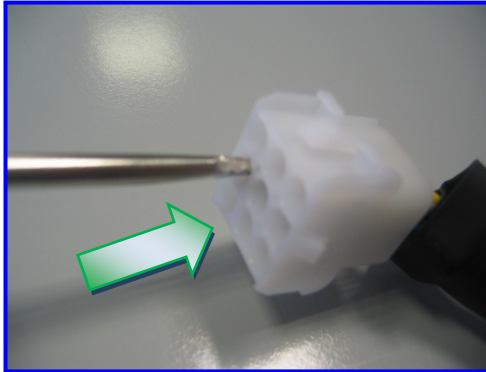

CAUTION: BEFORE PERFORMING THIS OPERATION , PLEASE MAKE POWER SUPPLY IS DISCONNECTED

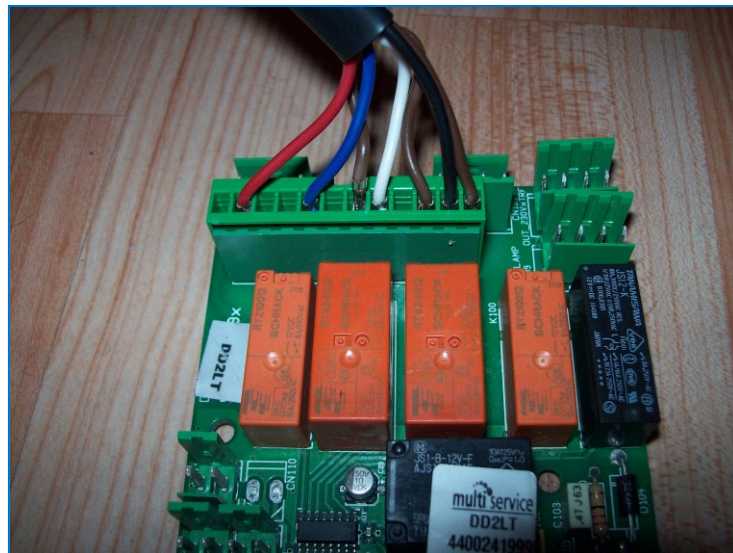

Check if the 6 pole connector wires of the suctioning unit in the main electric system board are connected properly and all the pins of the green connector inside the board are inserted properly

- For internal motor version, check the connections accordingly to the following diagram

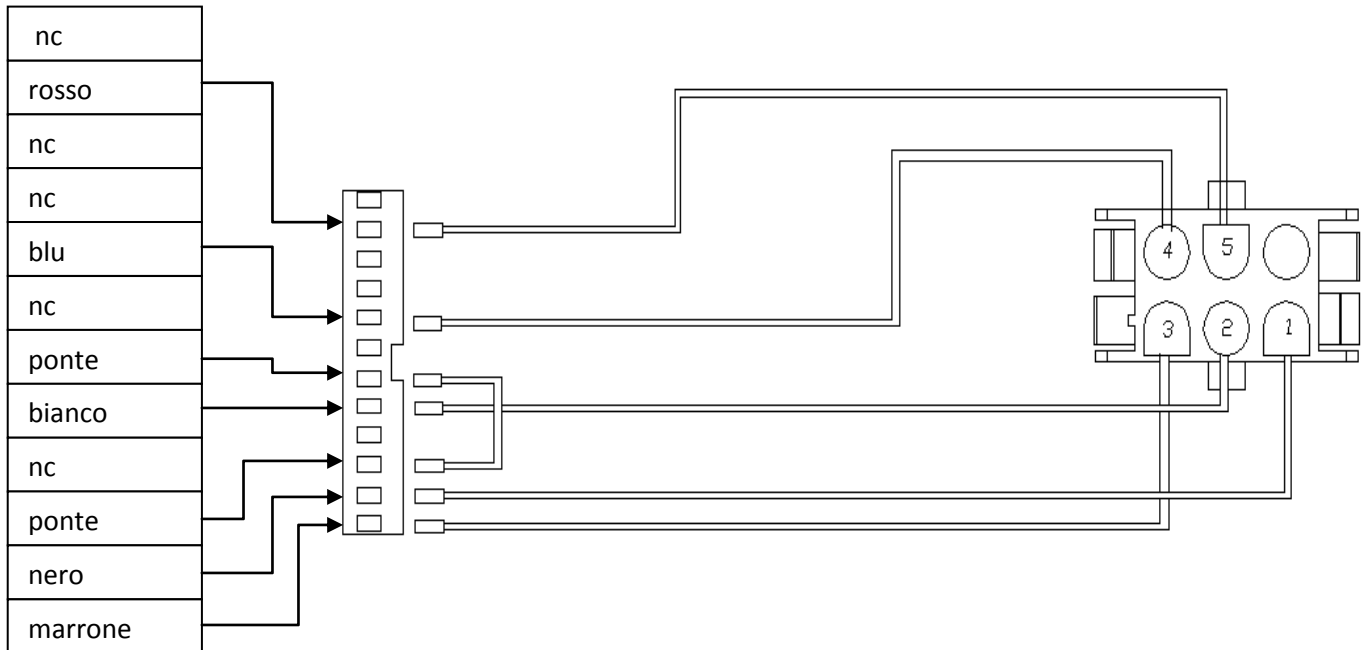

- For external motor (EM) version, check the connections accordingly to the following diagram.

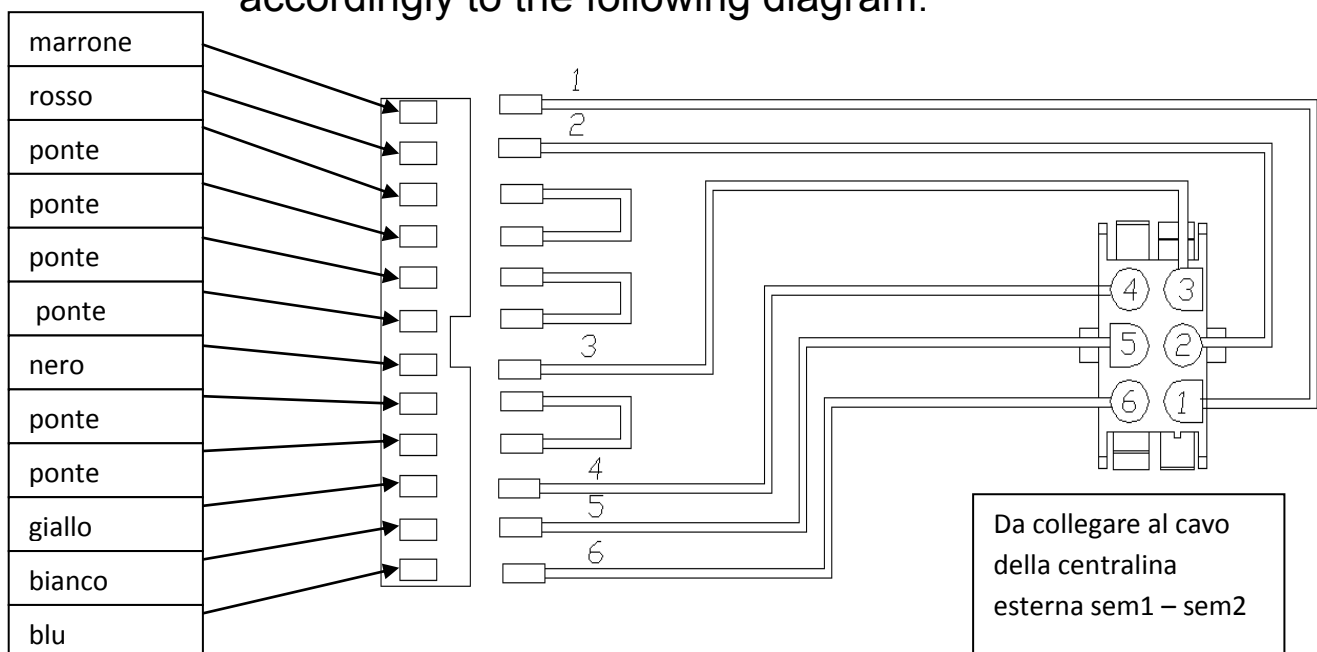

“NEL CASO DI COLLEGAMENTO CON CENTRALINE ESTERNE SEM ASSICURARSI CHE IL CAVO DI CONNESSIONE DI 7MT CHE COLLEGA LA CAPP A IL MOTORE ESTERNO NON SIA STATO TAGLIATO O MANOMESSO”

- Check the connections in such a case

SEM1 – SEM5

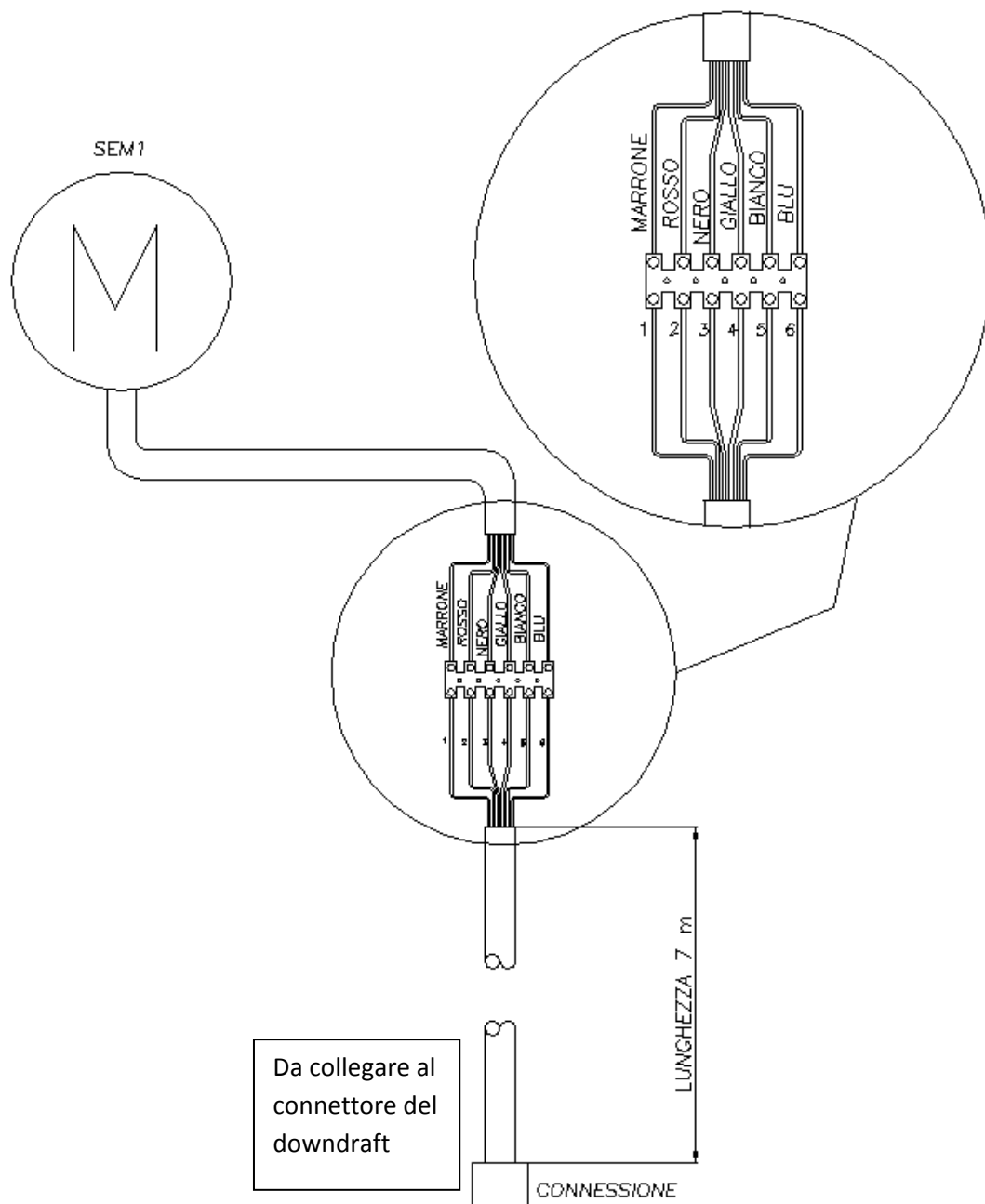

SEM2

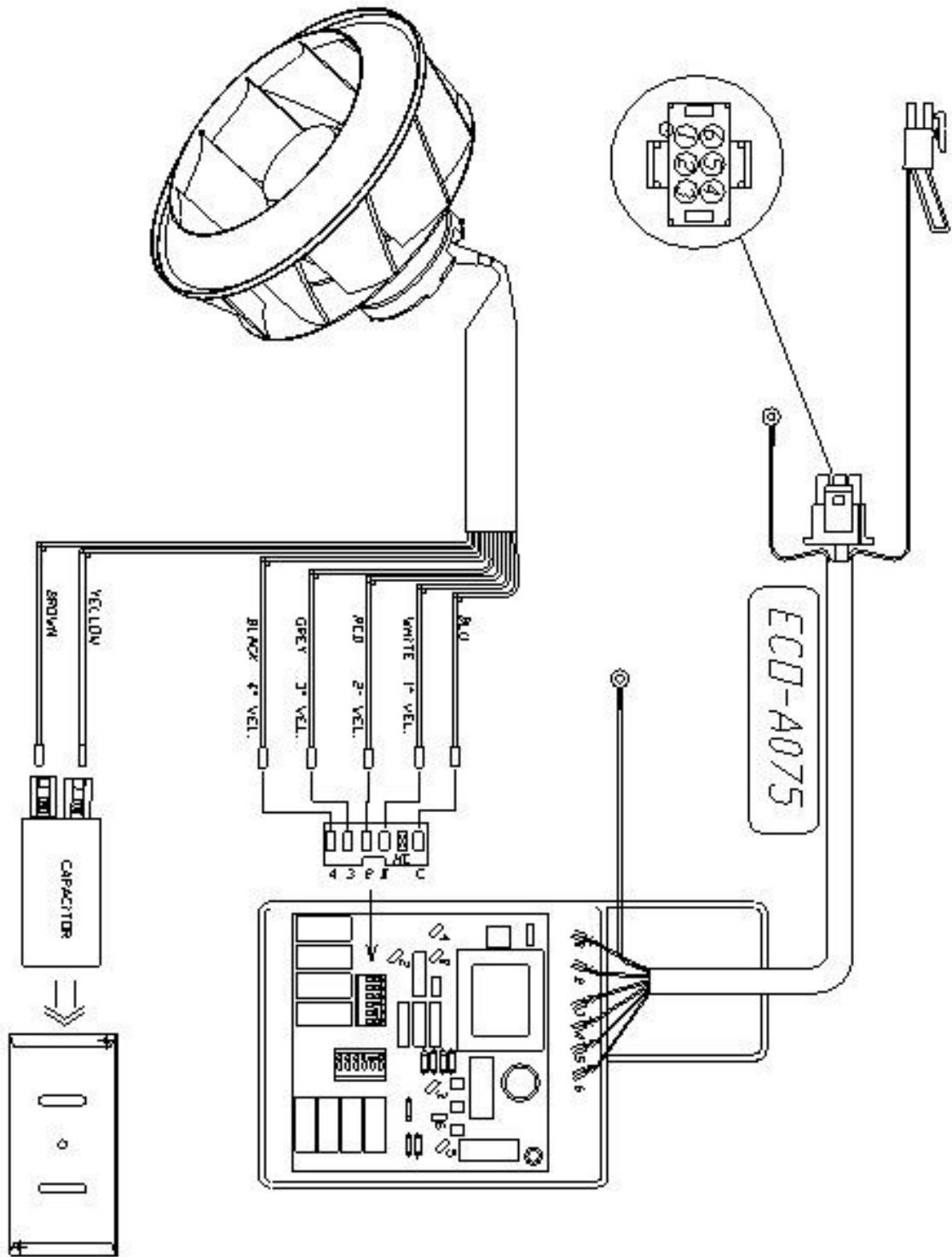

SEM8

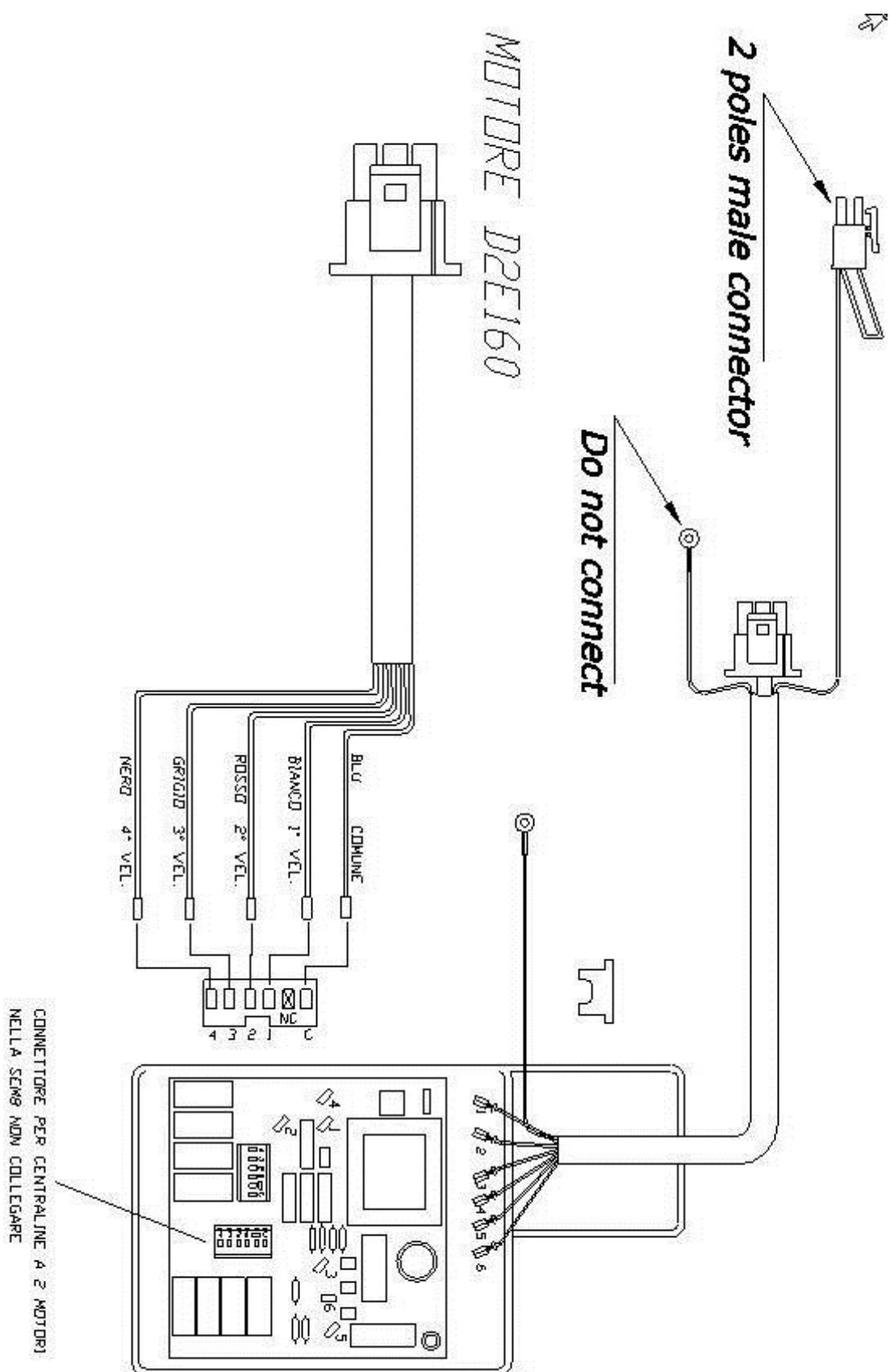

IN CASO DI MOTORE A BORDO, Check if the 6 pole connector of the suctioning unit is connected properly and if all the pins of the connector are properly inserted inside the connector itself.

- You need to remove the suctioning unit assembly from the downdraft, by unscrewing the 8 M4 screws
“To perform this operation you only need to remove the suctioning unit; in case it is not possible please remove the entire box of the suctioning unit assembly ”
- If it is possible to remove only the suctioning unit, unscrew the 10 top screws that secure the unit and remove it.



- Check if the connector is inserted properly, pull the sheath outwards and make sure the wires are well inserted into the connectors, according to the colours scheme shown in the figure below.

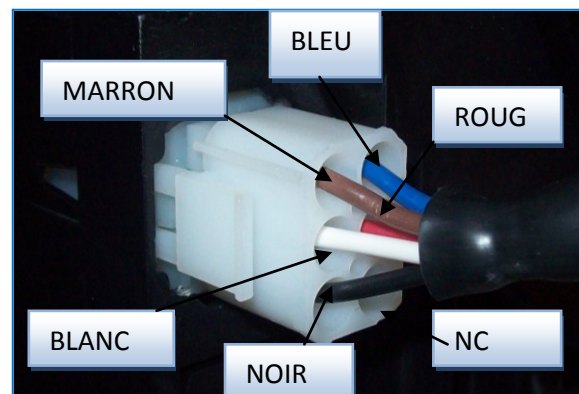
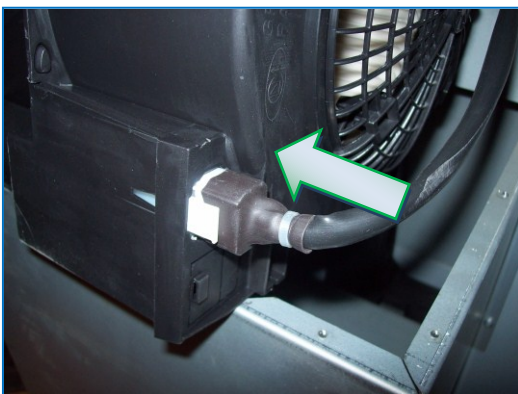

- If it is not possible to remove the unit being the downdraft already fitted into the cabinet , you need to remove the entire suctioning unit box , by unscrewing the 8 screws which secure it to the body.



- Then remove the unit as previously shown.

CHECK IF THE RELAYS INSIDE THE BOARD SWITCH OVER PROPERLY WITH PRESSURE OF SPEED CHANGE FROM THE PUSH-BUTTON PANEL.

- Make sure there is power and the red button is pressed. Press the speed variation + and – key .
- Open the electric system box and check if the motor relays are switching over .

“When pressing the speed variation key a “CLICK” should be heard ”

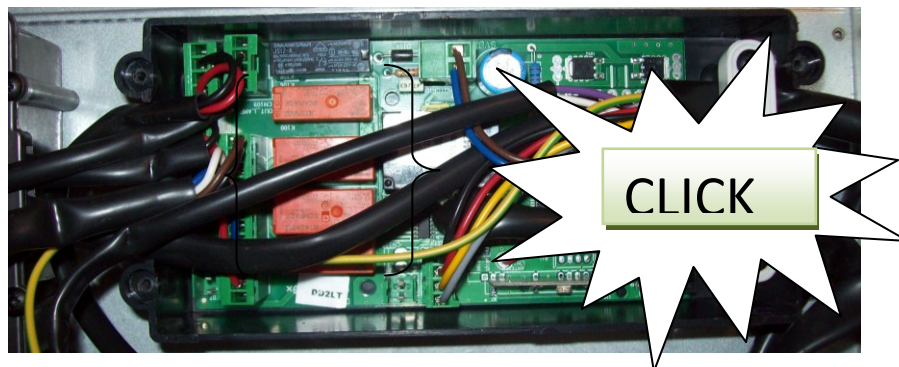

Replace the main electric system board

- See pag. 23

Replace the suctioning unit

- Remove the fixing screws from the fan support plate and lift the suctioning unit up

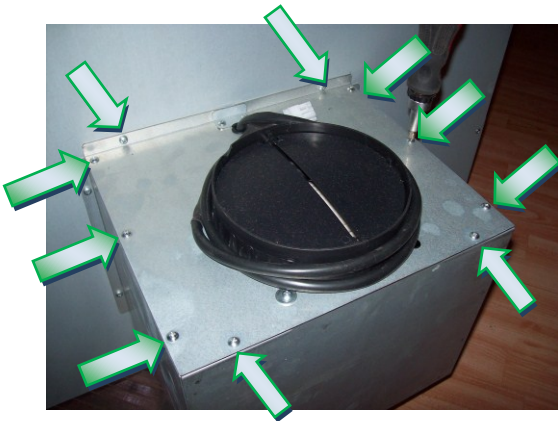

- Disconnect the connector.

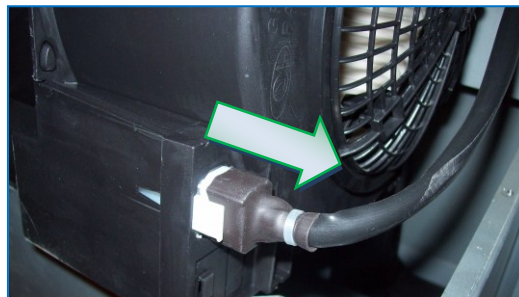

- Unscrew the two safety screws of the suctioning unit.

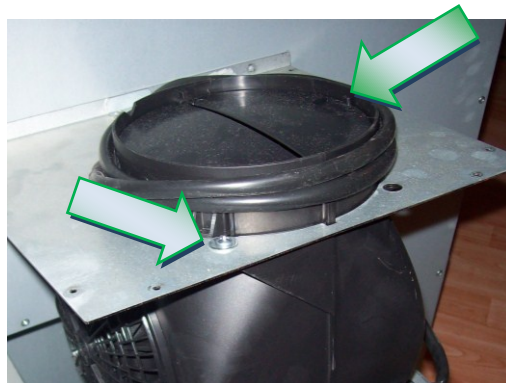

- Push the air out-let side tongues of the suctioning unit and pull it downwards.

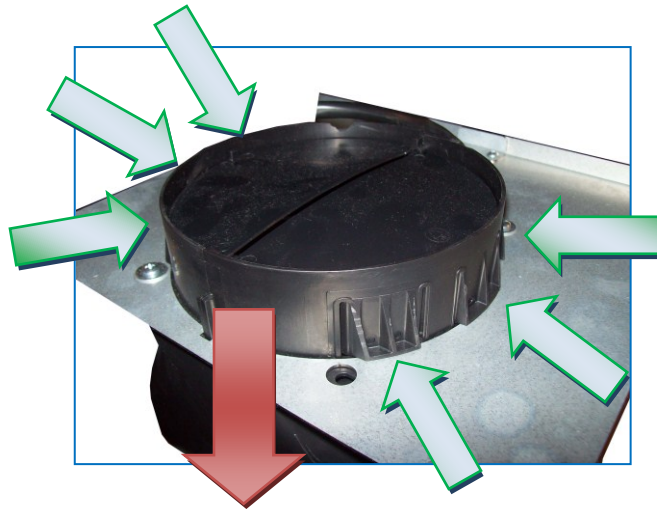

- Replace the suctioning unit with a new one of the same kind (see the spare parts list).

PROBLEM

3. THE STAINLESS STEEL BODY LINER IS DAMAGED

POSSIBLE SOLUTION

REPLACE THE BODY LINER

- Disconnect the downdraft from power supply

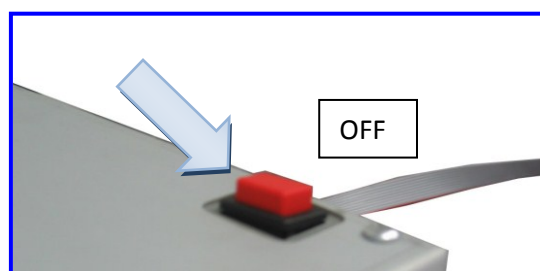

- Remove the brackets which fix the downdraft to the cabinet



- In case of internal motor version, remove the motor fixing screws and remove the suctioning unit.



- In case of external motor version (EM) remove the air-outlet flange.



- Lift the downdraft up from the cabinet



- Ricollegare i connettori e far salire il carrello
- Togliere il frontale superiore (vedi pag.17)
- Scollegare il cavo piattina

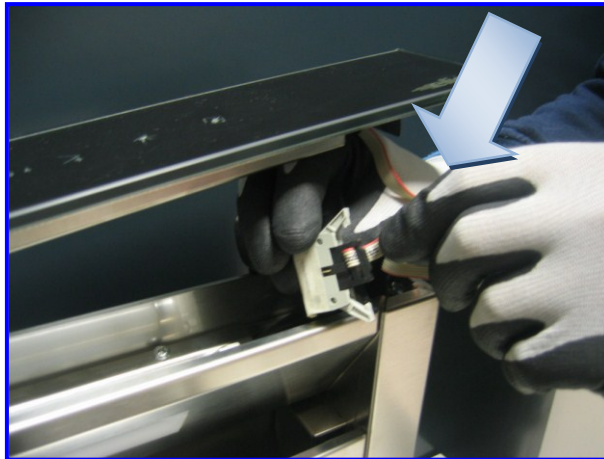

- Nella parte posteriore e laterale togliere le viti che fissano il bordo carcassa.

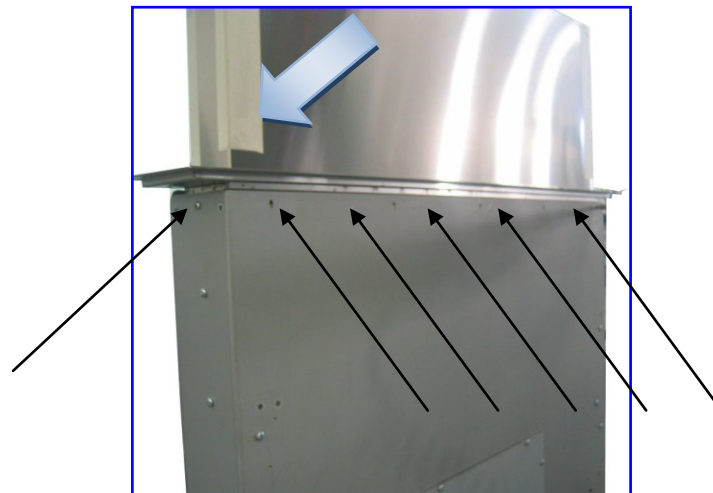

- Before removing the body liner from the extractable unit , we recommend to use protective adhesive paper in order to avoid the extractable unit to be scratched

ATT: Esistono due tipo di bordo carcassa quello standard e quello FLUSH TOP, prima di smontare il bordo carcassa assicurarsi che il ricambio sia corretto.

Per entrambi i modelli:

- Remove the body liner.

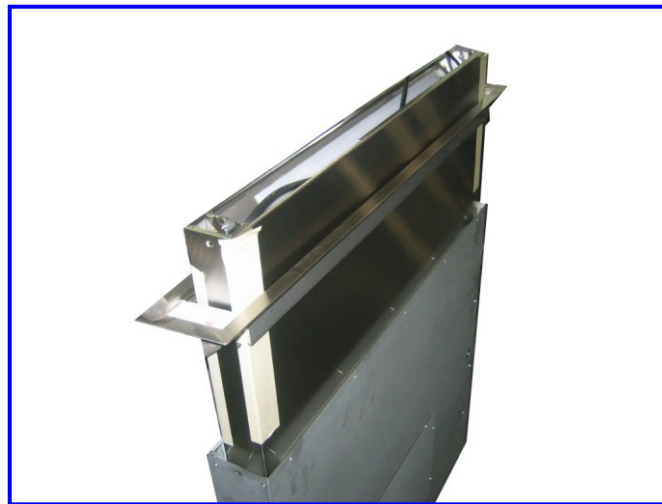

PROBLEM

4. THE SUCTIONING SYSTEM WORKS PROPERLY BUT THE EXTRACTABLE UNIT DOES NOT OPEN

POSSIBLE SOLUTION

CHECK IF THE ELECTRICAL SYSTEM CONNECTORS ARE CONNECTED PROPERLY

- Disconnect the downdraft from power supply

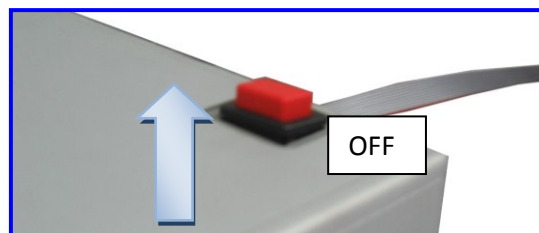

- Check if the 9-pole connector male and female contacts are connected properly.

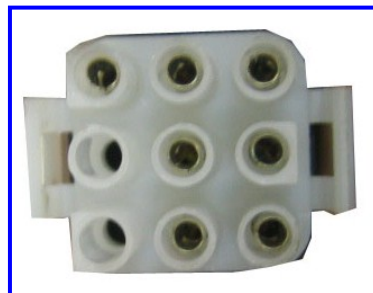
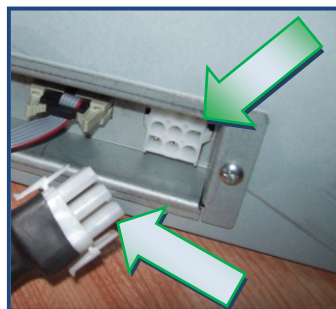

- Release the movable connector wires by removing the black sheath.

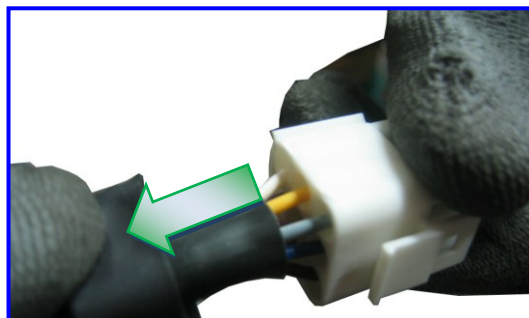

- Check if the connector inner contacts are inserted properly, with the help of a screwdriver. Carry out this check in both the movable and the fixed connectors.

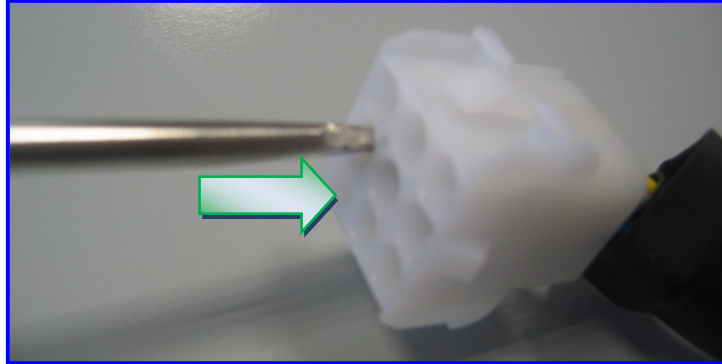

- Check if the brown and blue wires contacts are inserted properly.
- Check connections according to the wiring diagram

Actuator

- PIN 9 BROWN COLOUR
- PIN 8 BLUE COLOUR

- Check if the blue and brown wires of the connector in the electric system board are connected properly.

(Caution: There are about 12V in the connector during the actuator rise . The 12 V will disappear if you disconnect the connector , since the board does not recognize the actuator presence . Therefore , DO NOT perform any tension measurement if the actuator is not connected.)

ALIMENTAZIONE
ATTUATORE DAL
CONNETTORE A 9
POLI
BLU/MARRONE

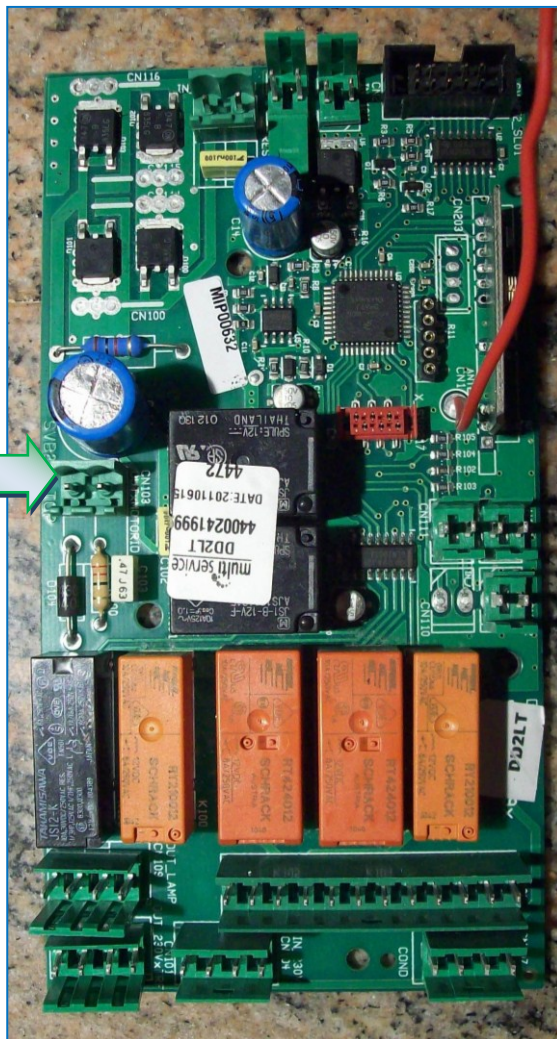

Check the internal connection of the actuator

- Remove the suctioning unit
- Remove the downdraft from the cabinet if necessary.



- Find the actuator connection in the right side opening of the suctioning unit.

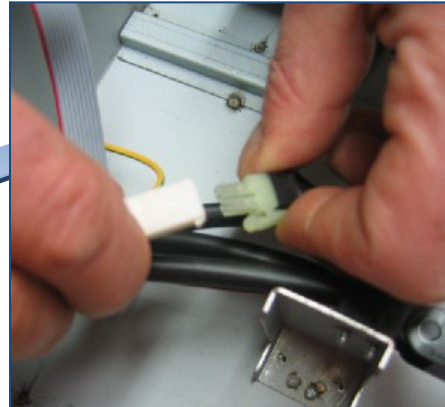

- Check if the 2-pole connector (blue and brown wires) for the actuator feeding is inserted properly and the pins inside the connector are crimped properly.

CHECK IF THE ELECTRO-MECHANICAL TRANSFORMER PLACED INSIDE THE ELECTRIC SYSTEM BOX IS WORKING PROPERLY

- Remove the electrical system box cover.

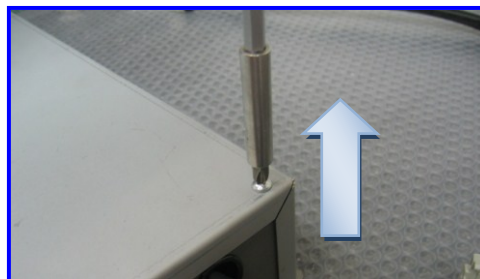

- Find the electro-mechanical transformer



- Remove the terminal box protection by unscrewing the two screws.



- Check if there are 220V in the transformer primary and about 12V in the transformer secondary.

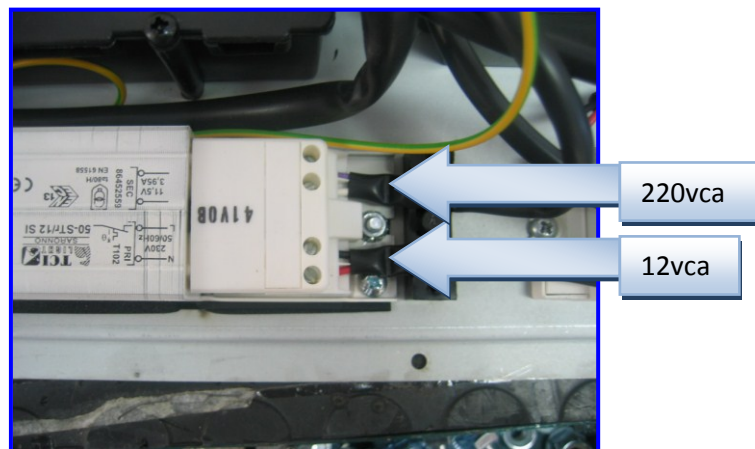

About 12 V should be found also in the CN102 board connector

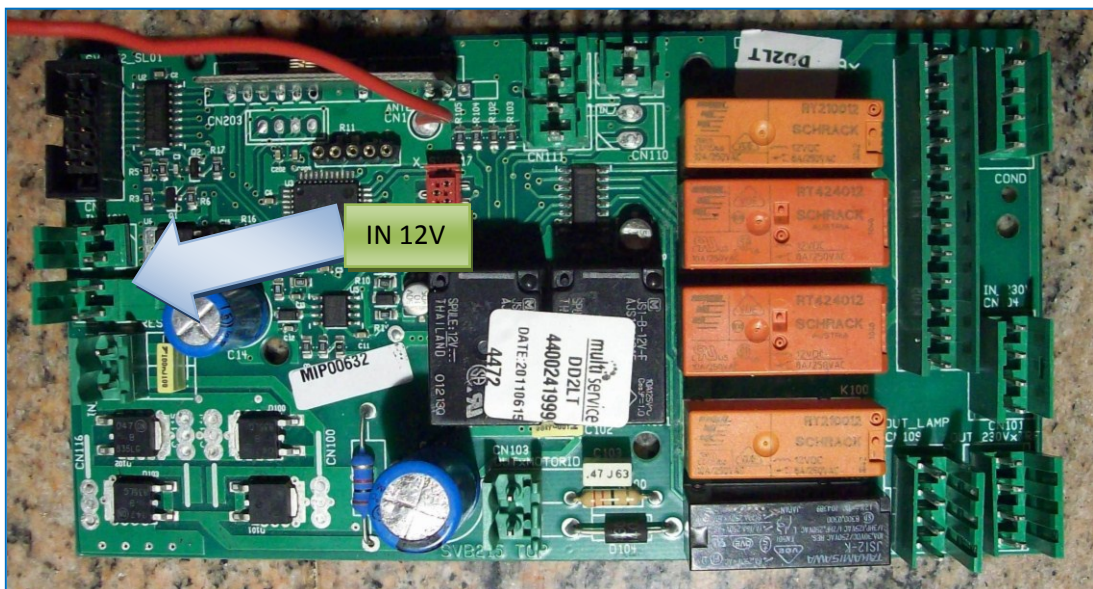

REPLACE THE ACTUATOR

- Disconnect power supply
- Remove the 9-pole connector in the suctioning unit

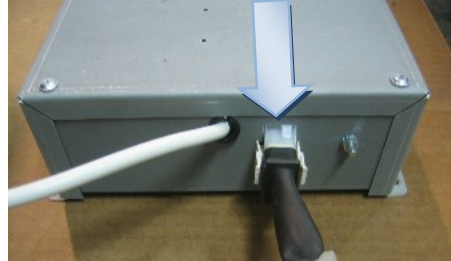

- Dismount the suctioning unit, by taking the no.8 screws (A) out.



- Scollegare tutti i connettori

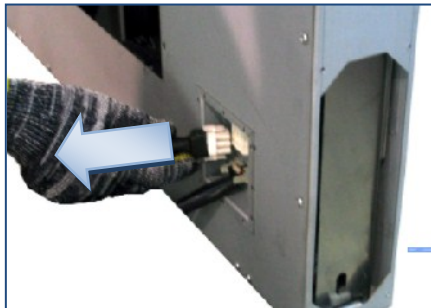

Remove the panel (A) from the body

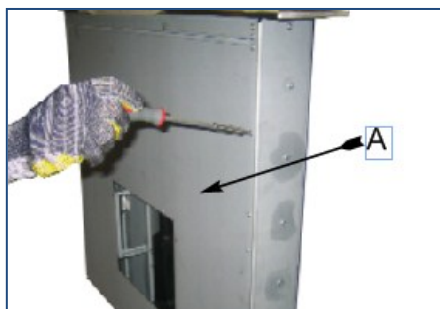

- Remove the actuator connection covering, by taking the three screws (A-B-C) out

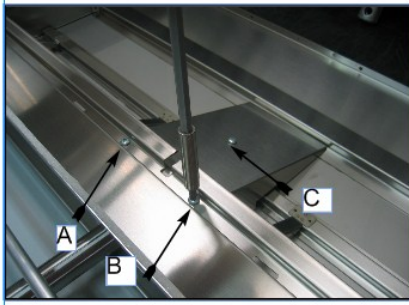

- Remove the lower side actuator screw by using two 17 mm keys

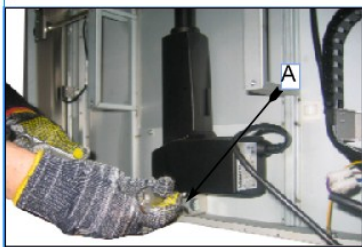

- Disconnect the actuator from the extractable unit by taking the M8 screw (A) out, using two 17 mm keys.

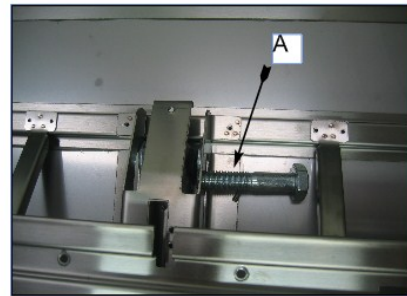

- Remove the actuator from the lower side of the downdraft

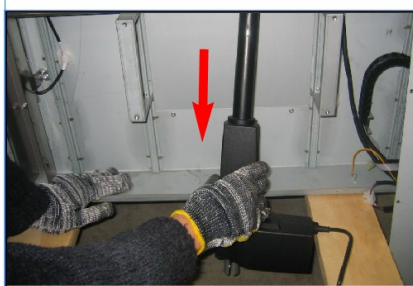

- Replace the old actuator with a new one
- Reconnect the electrical connections.

PROBLEM

5 THE EXTRACTABLE UNIT RE-OPENS BY ITSELF DURING AND AFTER ITS CLOSING

POSSIBLE SOLUTION

- CHECK IF THE SAFETY SENSOR IS WORKING PROPERLY

(The DOWNDRAFT is equipped with a safety sensor which changes the extractable unit direction if an obstacle is met during its closing . The sensor is a magnetic contact which is normally open and closes when the magnet , placed on top of the actuator, is placed in front of the sensor due to the obstacle.)

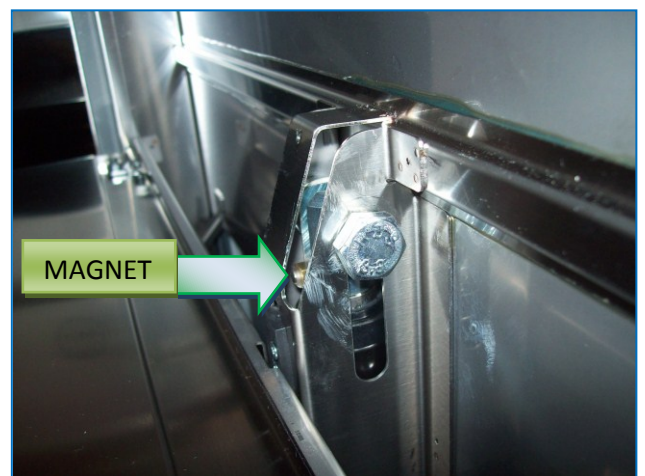
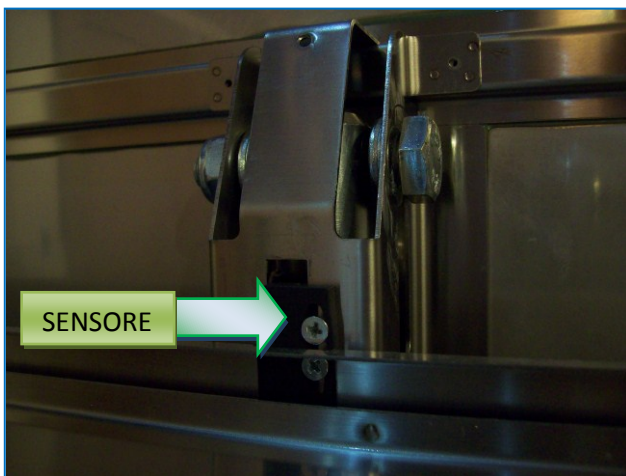

- To check the sensor proper working, you need to place the tester rods at the Yellow and Grey wires of the 9-pole fixed connector . If the sensor works properly the tester should show an open circuit

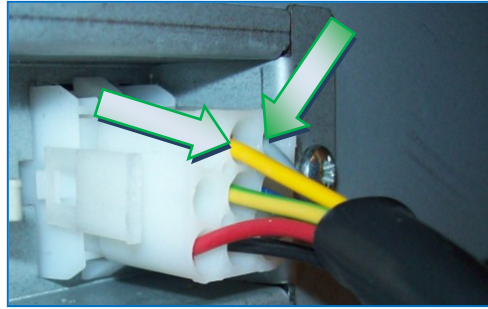

- Open the front panel to make sure the sensor is not damaged,

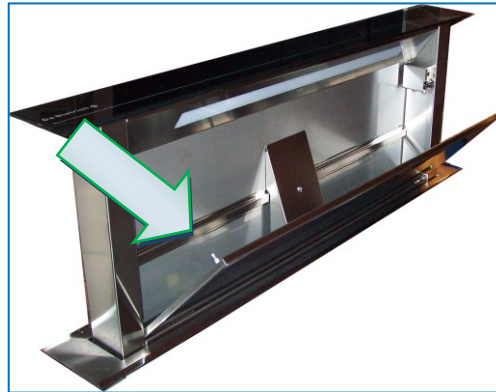

- Remount the actuator covering, using (A) (B) (C) screws

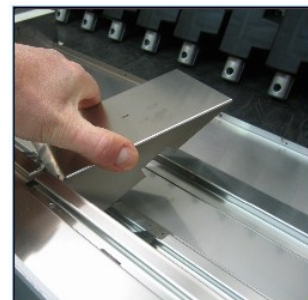
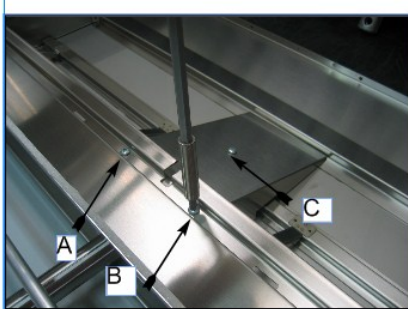

- Take a magnet and place it close to the sensor , then repeat the test using a tester : the circuit should be closed at this point.
- **Se senza l'utilizzo del magnete il circuito è chiuso, munirsi di un giravite con punta a croce e spostare la posizione del sensore verso il basso.**

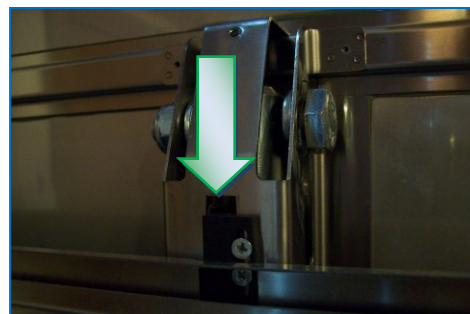

- If the circuit is still closed after having moved the sensor, you need to replace the sensor . Unscrew the two screws, cut all of the sensor cable fixing clamps and remove the sensor by pulling it from the bottom.

(Since the magnet shall be placed in the same position of the damaged one, carefully check the cable, clamps and sensor position before removing the magnet.)

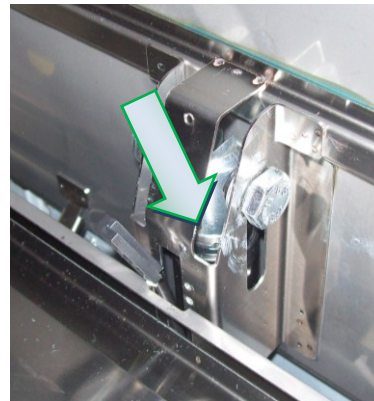

- Then cut the sensor cable and replace it with a new one, welding its wires with a soft-soldering welder.



- Refit the sensor in its downwards position and the cable fixing clamps as well.

CARRY OUT THE CALIBRATION RESET. (SOLO SDD2-L)

(The DOWNDRAFT sdd2-l has a setting device placed inside the electronic board which adjusts the actuator effort during rising and falling . This setting is performed automatically every 3 complete opening and closing cycles of the extractable unit . It may happen that

this setting is not performed properly during the automatic calibration procedure, due to some problems with the software)

- To carry out the calibration reset you need to press the timer key 6 times consecutively, (about 2 seconds should pass between one press and the other)

The reset has been performed successfully if all of the speed indicators flash at the sixth press

EFFETTUARE CALIBRAZIONE DEL DOWNDRAFT SOLO PER MODELLO SDD2

After having installed the downdraft and after having connected it to the electrical net, press the red button on the wiring box and run the calibration as follows:

Press the ON/1 button (S-DD2) or the ON/+ (S-DD2TC) the aspiration panel rises. After it has reached a height of 18Cm from the cooktop, press the ON/1 button (S-DD2) or the OFF button (S-DD2TC) to stop the extraction. Then press Timer and after 2 seconds the OFF button (S-DD2TC) button. The downdraft will carry out the calibration rising and retracting for some centimeters. During this phase, the buttons on the push-button control panel blink. At the end of the calibration, let the extractable unit goes down pressing the OFF button.

SOSTITUIRE IL FRONTALE PULSANTIERA

- See pag.20

SOSTITUIRE LA SCHEDE IMPIANTO ELETTRICO PRINCIPALE

- See pag.22

PROBLEM

6. THE PUSH-BUTTON PANEL DOES NOT LIGHT UP

POSSIBLE SOLUTION

CHECK IF THE PUSH-BUTTON CONNECTOR IS CONNECTED PROPERLY

- See pag.26

SOSTITUIRE LA PULSANTIERA

PER SDD2 CON FRONTALE VETRO

- Take the right and left minilatch cover out, by pulling it outwards.



- Remove the 4 screws of the head lower cover and take the covering out by pulling it outwards



- Take the under head 5 screws and the two lateral screws out

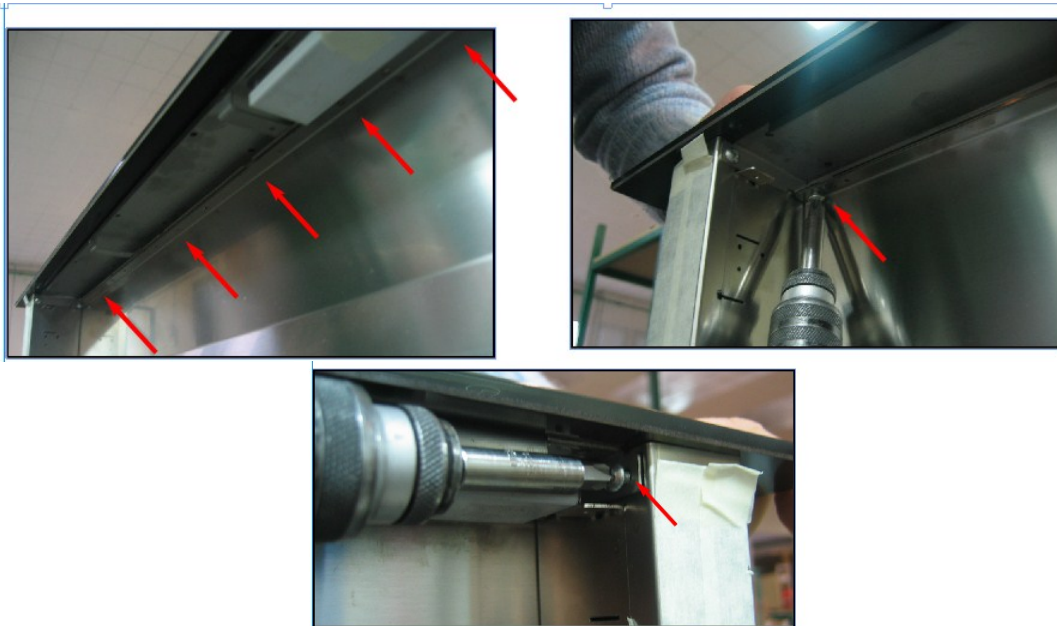

- Lift the front panel up and disconnect the connector; then remove the front panel.

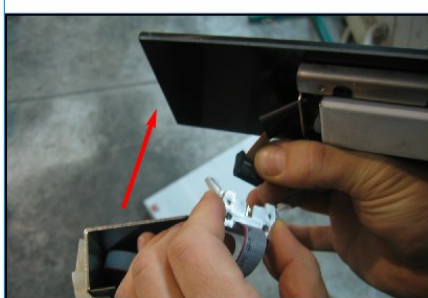

- Replace the front panel with the new push-button
FOR PUSH-BUTTON IN A STAINLESS STEEL FRONT PANEL , AFTER HAVING REMOVED THE STAINLESS STEEL FRONT PANEL, FOLLOW THE STEPS BELOW:
 - Remove the upper front panel as shown in chapter 18
 - The push-button panel that Sirius supplies as spare part is equipped with a flat and a connector (A)

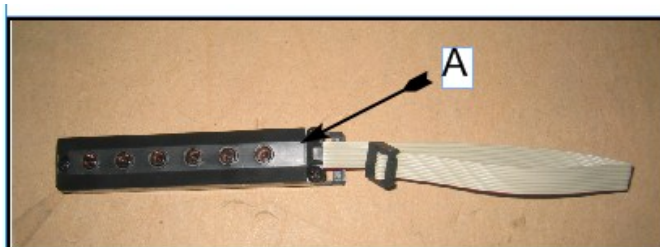

- Unscrew the two threaded dowels (A) and (B) to the right and left of the push-button panel

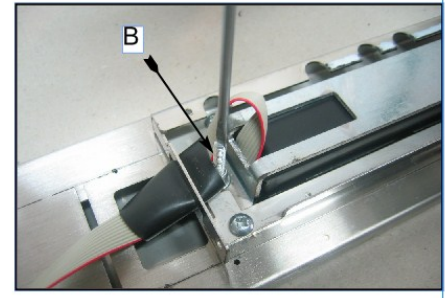
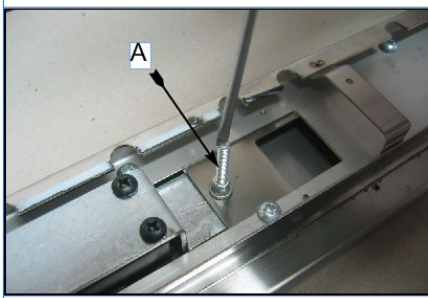

- Place the front panel in vertical position, apply a light pressure on the keys and take the push-button panel out

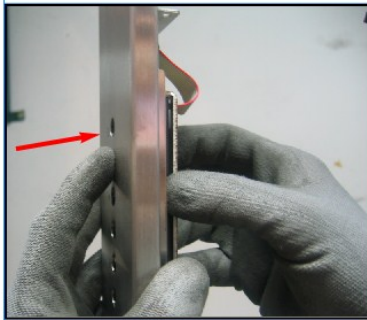

- Remove the metal support , taking out the n°3 self-tapping screws which hold the push-button panel

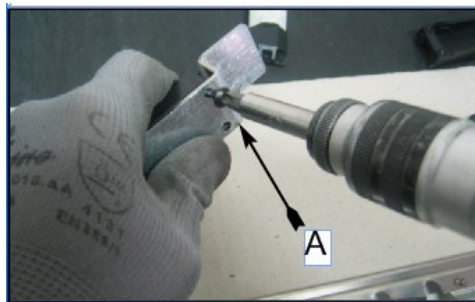

- Then, if the push-button panel to replace can not be reused , it is possible to cut the flat in order to make the push-button panel removing easier..

ATTN: Keep the protection black sheath (A) of the damaged push-button panel

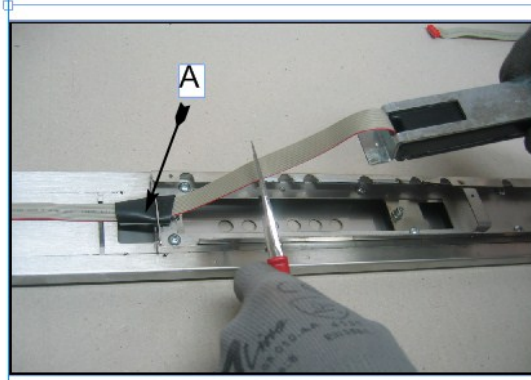

- Take a new push-button panel and break the plastic piece shown in figure (A)

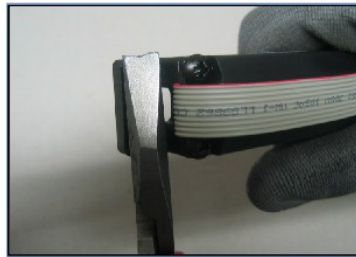
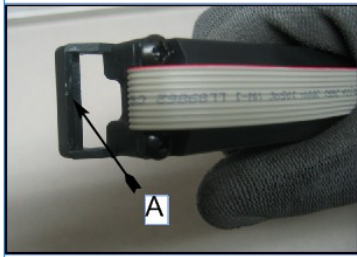

- Protect the keys with adhesive paper , if possible



- Open the push-button and disconnect its flat (A)

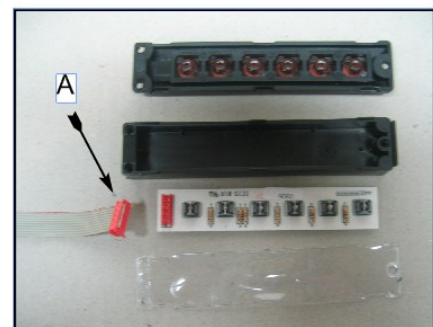

- Insert the flat from the red connector side , inside of the push-button seat buttonhole, keeping its pins oriented upwards.

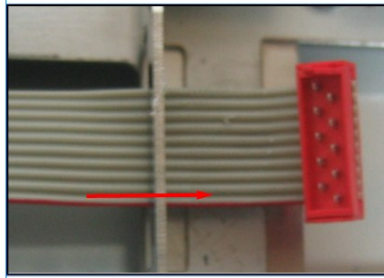

- Take the black sheath previously removed from the flat and put it in the new push-button flat (A)

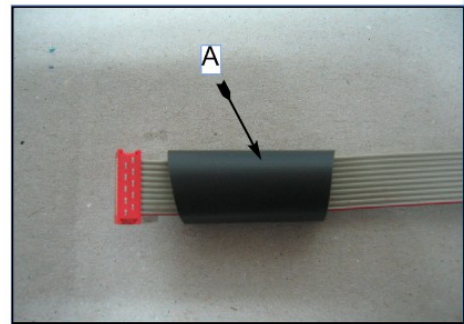
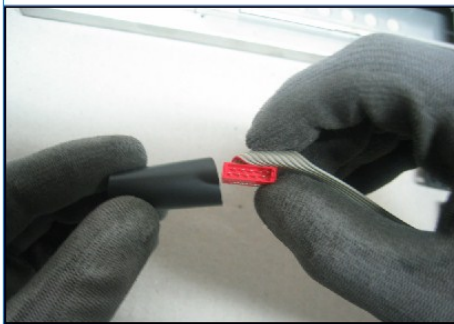

- Insert the flat onto the bracket (A)

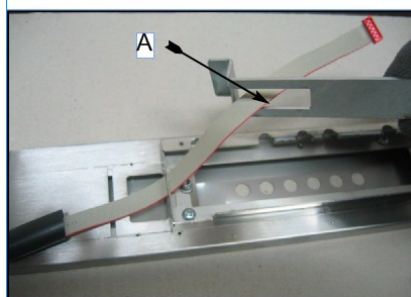

- Connect the flat to the control board, making sure to fix it properly

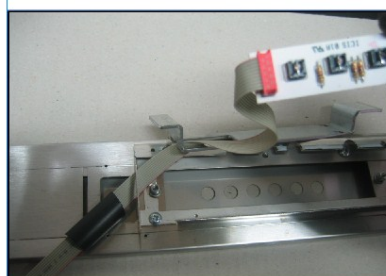

- Then, fix the lower side of the push-button box to the metal bracket



- Place the control terminal board inside the plastic box.

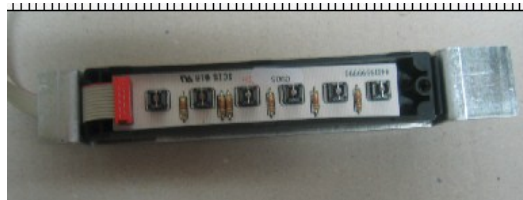

- Close the control box, making sure that keys are positioned properly



- Remove the protective film



- Reinsert the push-button bracket inside the upper front panel



- Place the sheath between the flat and the sheet piece of the front panel (A)

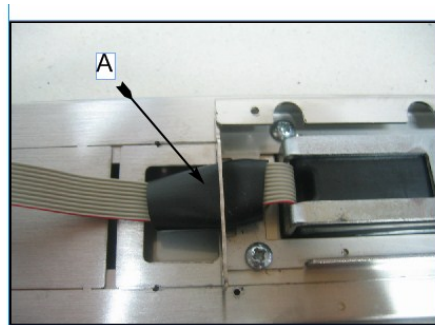

- Fix the push-button with the M4 (A) dowels

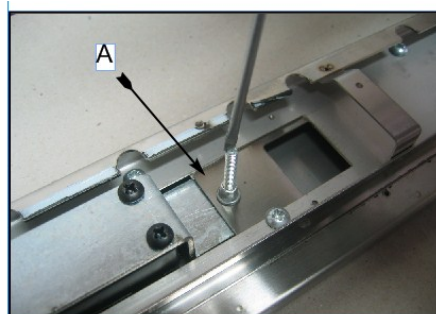

- Check if keys have been inserted properly..



- Remount the upper front panel.

Per sostituire la pulsantiera nel caso di SDD2-L con frontale INOX, procedere come segue:

- Unscrew the two dowels which fix the push-button bracket.

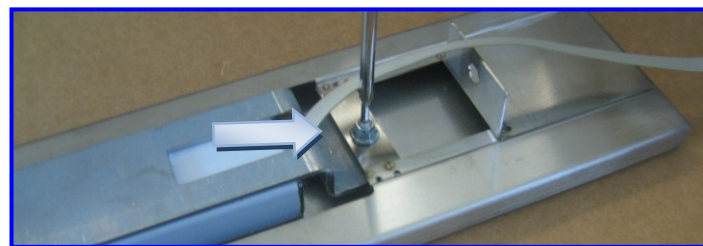

- Remove the push-button support



- Remove the push-button stainless steel cover

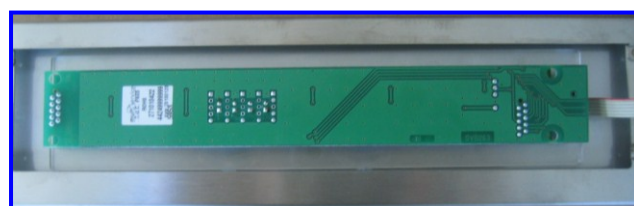

- Remove the push-button panel and replace it with a new one, remount the push-button cover, the push-button bracket and related connections.

REPLACE THE MAIN ELECTRICAL SYSTEM BOARD

- See pag. 22

PROBLEM

7. LIGHTING DOES NOT LIGHT UP (solo per modello SDD2-L)

POSSIBLE SOLUTION

REPLACE THE NEON LAMP (TUBE)

- Sollevare il carrello premendo il tasto ON e successivamente togliere alimentazione.

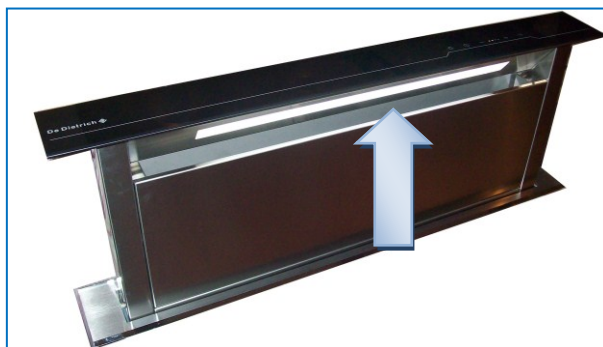

- Remove the upper front panel

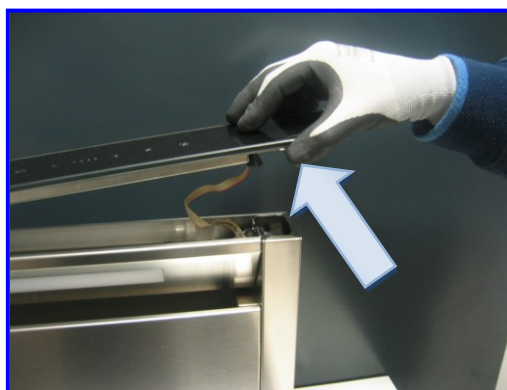

- Disconnect the flat cable

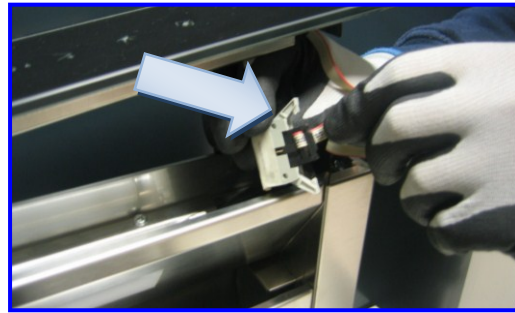

- Remove the neon tube and replace it with a new one.

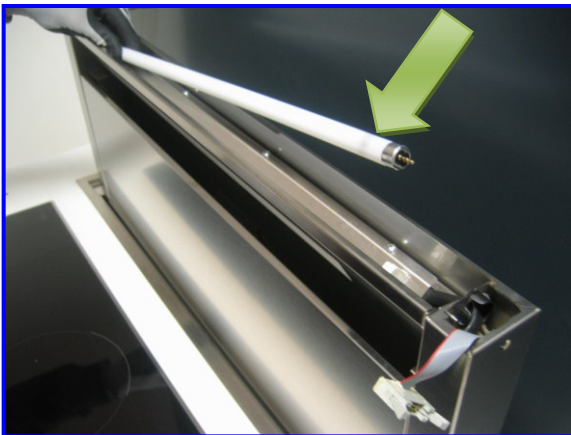

NARVA
LT 14WT5/865 cool daylight
www.narva.be

- Remount the upper front panel and reconnect the flat cable ; then check the neon tube operation.

CHECK THAT THE NEON TUBE SUPPORTS ARE NOT DAMAGED AND ARE CONNECTED PROPERLY.

Unscrew the neon tube support by removing its screws

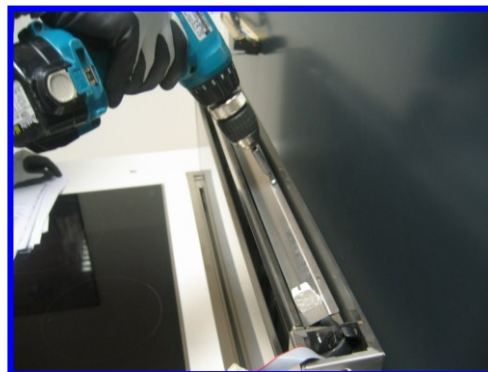

- Check if wires inside the neon tube holders contacts are inserted properly

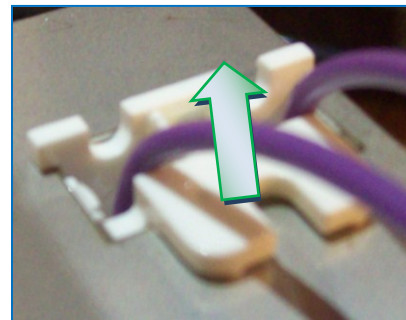
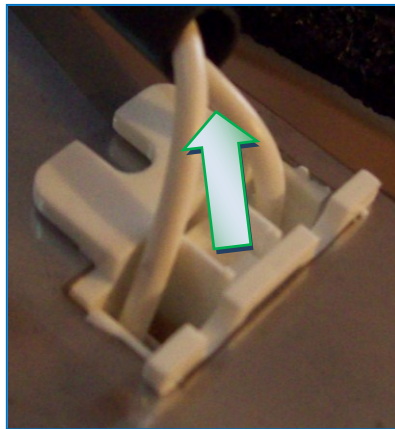

- Carry out an electric continuity test between the neon tube holders and the ballast inside the electrical system box.
- Place a test prod in one of the neon tube holders contacts and check the ballast continuity inside the electric system box.

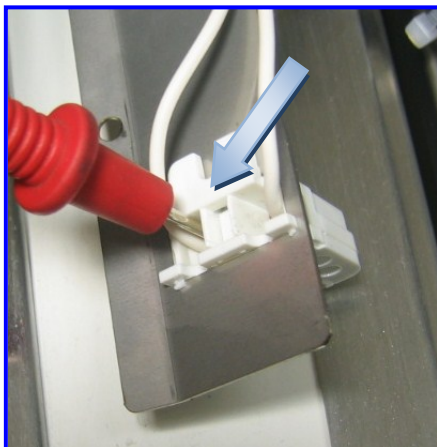

- Carry out the same test in all the four ballast prods.

REPLACE THE NEON TUBE SUPPORTS

- In case one of the neon tube support is broken , it is necessary to replace it with a new one

- Disconnect power supply
- Disconnect the wires of the neon tube holder to be replaced, by using a suitable tool

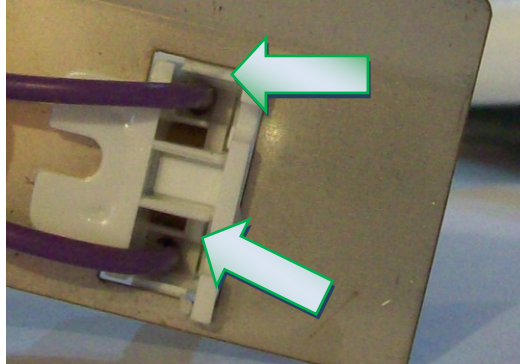

- Push the tongues placed in the upper side of the neon tube holder and remove the component by moving it downwards.

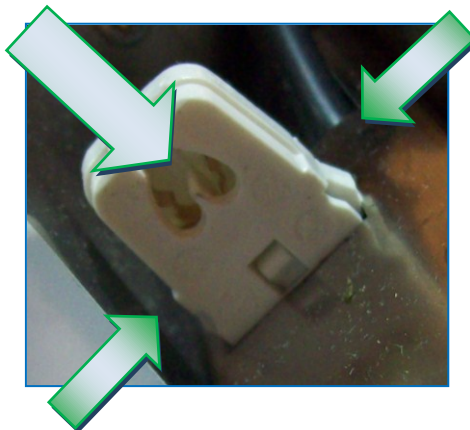

CHECK IF THE BALLAST INPUT VOLTAGE IS 230V

CAUTION: THIS OPERATION SHOULD BE PERFORMED WITH THE APPLIANCE CONNECTED TO POWER SUPPLY

- Lift the extractable unit up and press the light key

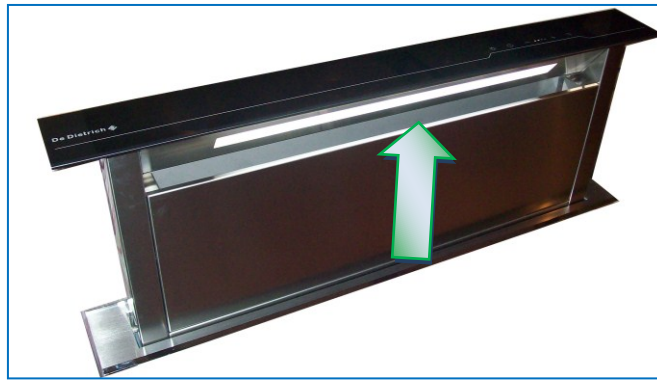

- Remove the electric system box cover by unscrewing its 4 screws.



- Find the neon tubes ballast



- Place the test prods at the ballast inlet and check if there are 230V.



REPLACE THE BALLAST

- Disconnect power supply, by removing the plug from the electrical network or by opening the magneto-thermal switch if present.
Disconnect the ballast wires by using a screwdriver and by pushing on the side shown in the figure

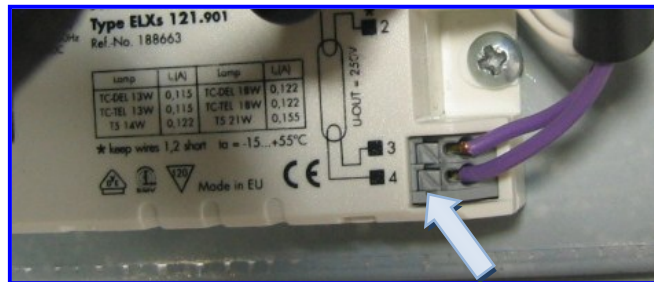

REPLACE THE MAIN ELECTRICAL SYSTEM BOARD

- See pag. 22

REPLACE THE PUSH-BUTTON PANEL.

- See pag. 52

PROBLEM

8. THE FILTERS ALARM SIGNAL AFTER 30 HOURS WORKING DOES NOT RESET WHEN PRESSING THE TIMER BUTTON

POSSIBLE SOLUTION

DISCONNECT AND RESTORE POWER SUPPLY

- Press the reset key and then disconnect the appliance from power supply.

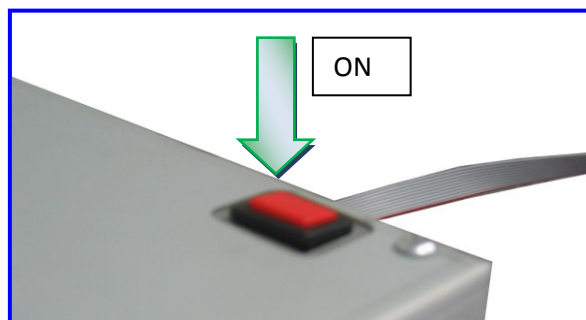
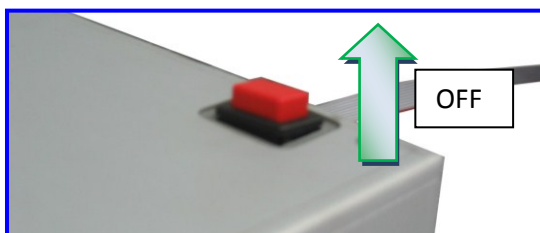

REPLACE THE PUSH-BUTTON PANEL

- See pag. 52

REPLACE THE MAIN ELECTRICAL SYSTEM BOARD

- See pag. 22

9. THE DOWNDRAFT AIR-CAPACITY IS INADEQUATE

CHECK THE SUCTION DUCT LENGTH

- In order to assure good air capacity performance , the downdraft air-outlet pipe should be as shorter as possible and the number of elbows should be limited as much as possible : we recommend not to exceed 5 linear meters piping.

CHECK THE AIR OUTLET PIPE SECTION

- The air-outlet pipe section must have a constant diameter of 150mm for its whole length. In case a flat piping is used, its section should always be the same as the 150 mm pipe at least

MAKE SURE THERE ARE NO OBSTRUCTIONS ALONG THE PIPE

- The piping should be free in all of its length and the grid used as terminal should allow the air out-let (AVOID to use too close grids preventing the air out-let) both in suctioning and filtering mode. The air shall flow freely without any obstacles

CHECK IF THE CHARCOAL FILTERS ARE STILL IN GOOD CONDITIONS IN CASE OF FILTERING VERSION

- In case of filtering version, please check if the charcoal filters inside the downdraft are in good conditions; if not, replace them with new ones. Charcoal filters shall be replaced every six months at least.

CHECK IF THE NON-RETURN VALVE TONGUES CAN MOVE FREELY.

- The suctioning unit has some non-return tongues placed on its air out-let, so that air cannot come back into the room from the cooker-hood in case of wind. When performing the pipe connection, make sure that no screws are used which may block the valves.

10. THE EXTRACTABLE UNIT OPENS, BUT IT DOES NOT STOP WHEN REQUIRED, AFTER 180 mm, AND THE SUCTIONING SYSTEM WORKS WHEN THE EXTRACTABLE UNIT IS COMPLETELY OPEN, AND STOPS WHEN THE EXTRACTABLE UNIT IS COMPLETELY CLOSED. (SOLO PER MODELLO SDD2)

CHECK IF THE 180MM SENSOR IS WORKING PROPERLY

- Take the black sheath out in the 9 pole movable connector coming from the electric system box..



- With the help of a multimeter, place the rods into the pins corresponding to
- violet (2) and
- white (1) colour

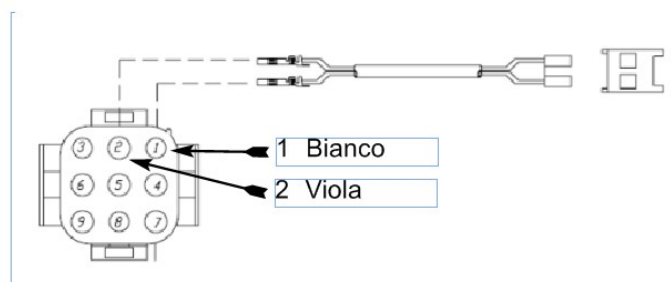

- Power the downdraft and activate the ON function

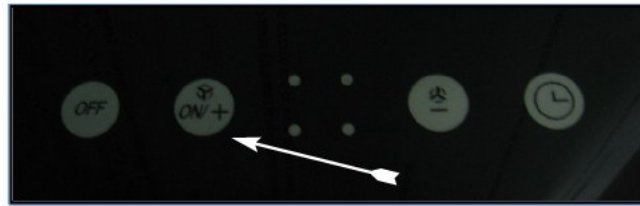

- If the sensor is working properly, when the extractable unit reaches 180 mm of height in the multimeter, some seconds of electric continuity must be noticed.
- If there is no electric continuity, check if the magnet (A) in the extractable unit column is placed properly.



REPLACE THE 180MM SENSOR

- Disconnect power supply
- Dismount the body panel (A)

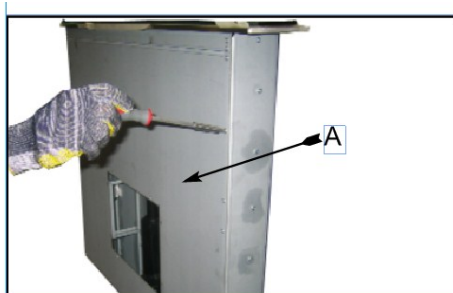

- Remove the 180mm sensor fixing screws

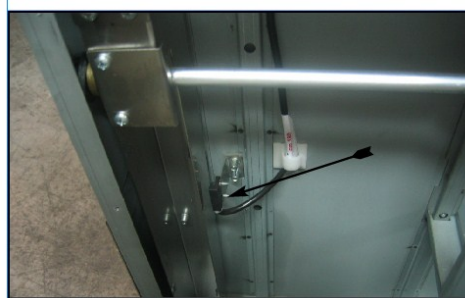

- Tagliare i fili del sensore e sostituire con uno nuovo.



Down Draft Trouble Shooting Guide



PROBLEM

**THE DOWNDRAFT EXTRACTABLE UNIT DOES NOT OPEN,
THE MOTOR DOES NOT WORK AND THE PUSH-BUTTON
PANEL IS OFF.**

Possible solutions

- Check if the network voltage is working
- Check if the red power button is in on position
- Check if the male and female connections in the 9 pin connector are connected properly
- Check if the circuit of the grease filters panel presence is closed
- Check if the grease filters cover panel is disengaged
- Check if the grease filter panel presence keys are working properly
- Check integrity of the grease filters panel presence residual circuit
- Replace the main electrical system board
- Replace the power supply system board
- Check the connection of the push-button panel connector
- Replace the upper front panel

PROBLEM

**THE EXTRACTOR UNIT OPENS BUT THE MOTOR DOES
NOT WORK AT ANY SPEED**

Possible solutions

- Check if the 6 pin connector of the motor cable is connected properly to the wiring and if all the connector pins are properly inserted into the connector itself.
- Check if the motor 6 pin connector wires in the main electrical system board are connected properly and if all the green connector pins are properly inserted inside the board.
- With the on-board motor Check if the motor unit 6 pin connector is connected properly and if all the connector pins are properly inserted inside the connector itself
- Check if the relays inside the board switch over properly with pressure of speed change from the push-button.
- Replace the main electrical system board
- Replace the motor unit.

PROBLEM
THE BODY LINER IS DAMAGED

Possible solutions
Replace the body liner

PROBLEM
THE MOTOR SYSTEM WORKS PROPERLY BUT THE EXTRACTOR UNIT DOES NOT OPEN

- Possible solutions**
- Check the Electrical connections are fitted properly and not damaged
 - Check the actuator connections
 - Check if the electro-mechanical transformer placed inside the control system box is working properly
 - Replace the actuator.

PROBLEM
THE EXTRACTOR UNIT RE-OPENS BY ITSELF DURING AND AFTER ITS CLOSING

- Possible solutions**
- Check if the safety sensor is working properly
 - Carry out the calibration reset
 - Make the calibration Replace the push-button front panel
 - Replace the main control system board

PROBLEM
THE PUSH-BUTTON PANEL DOES NOT LIGHT UP

- Possible solutions**
- Check if the push-button connector is connected properly
 - Replace the push-button panel
 - Replace the main control system board

PROBLEM
LIGHTING DOES NOT LIGHT UP
(ONLY FOR SDD2-L)

Possible solutions

- Replace the neon tube
- Check if the neon supports are not damaged and are connected properly.
- Replace the neon tube supports
- Check if the starter input voltage is 230V
- Replace the starter.

PROBLEM
THE FILTERS ALARM SIGNAL AFTER 30 HOURS WORKING
DOES NOT RESET WHEN PRESSING THE TIMER KEY

Possible solutions

- Disconnect and restore power supply
- Replace the push-button front panel.
- Check the ribbon cable at the control box and extractor
- Replace the main control system board.

PROBLEM
THE DOWNDRAFT AIR –CAPACITY IS INADEQUATE

Possible solutions

- Check the duct length
- Check the air outlet pipe section
- Make sure there are no obstructions along the pipe
- In a filtered version, check if the charcoal filters, are in good condition.
- Check the efficiency of all speeds in the motor unit.
- Check if the non-return valve flaps can move freely

PROBLEM

THE EXTRACTOR UNIT OPENS, BUT IT DOES NOT STOP WHEN REQUIRED, AFTER 180 mm, AND THE MOTOR WORKS WHEN THE EXTRACTOR UNIT IS COMPLETELY OPEN, AND STOPS WHEN THE EXTRACTOR UNIT IS COMPLETELY CLOSED. (SDD2 ONLY)

Possible solutions

- Check if the 180mm sensor is working properly.
- Replace the 180mm sensor

PROBLEM 1.
THE DOWNDRAFT EXTRACTOR UNIT DOES NOT OPEN,
THE MOTOR DOES NOT WORK AND THE PUSH-BUTTON
PANEL IS OFF.

Possible solutions

- **CHECK IF THE MAINS VOLTAGE IS THERE.**

Make sure the magnetic circuit breaker (life-saving switch) has not tripped and the system protection fuses are in good conditions. In this case you need to call a specialized technician in order to fix the problem.

- **CHECK IF THE RED POWER BUTTON IS IN THE ON POSITION**

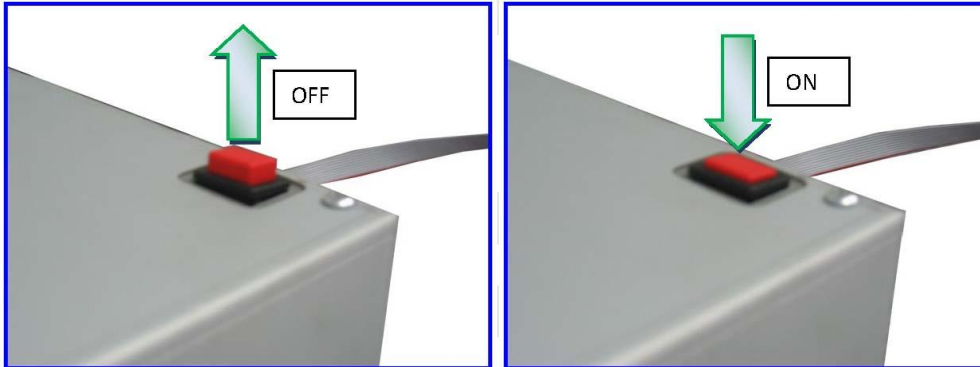

CHECK IF THE MALE AND FEMALE CONNECTIONS IN THE 9 PIN CONNECTOR ARE CONNECTED PROPERLY

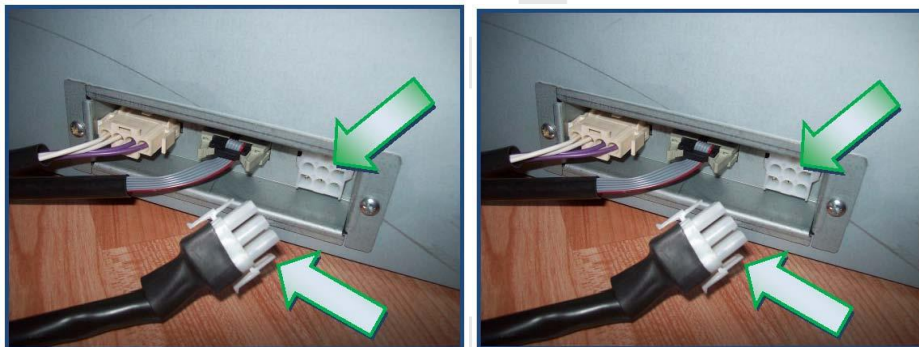

Disconnect power supply by pressing the red button on the control box

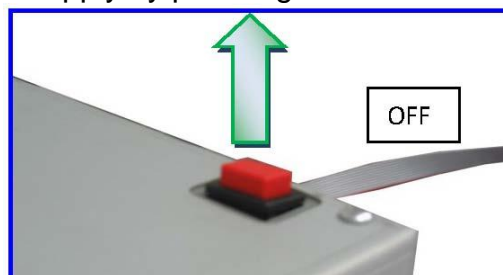

Check the connector wires by removing the black sheath.



Check if the connector inner contacts are inserted properly, by using a screwdriver. Carry out this check in both the fixed and the movable connectors.

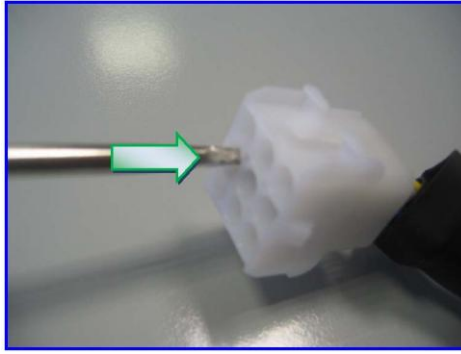

Grease filters panel presence buttons

- PIN 3 RED COLOUR
- PIN 6 BLACK COLOUR

Magnetic safety circuit breaker

- PIN 4 YELLOW COLOUR
- PIN 7 GREY COLOUR

Actuator

- PIN 9 BROWN COLOUR
- PIN 8 BLUE COLOUR

Ground connection

- PIN 5 yellow/green

Magnetic Sensor (180cm.) (SDD2 Only)

- PIN 2 VIOLET COLOUR
- PIN 1 WHITE COLOUR

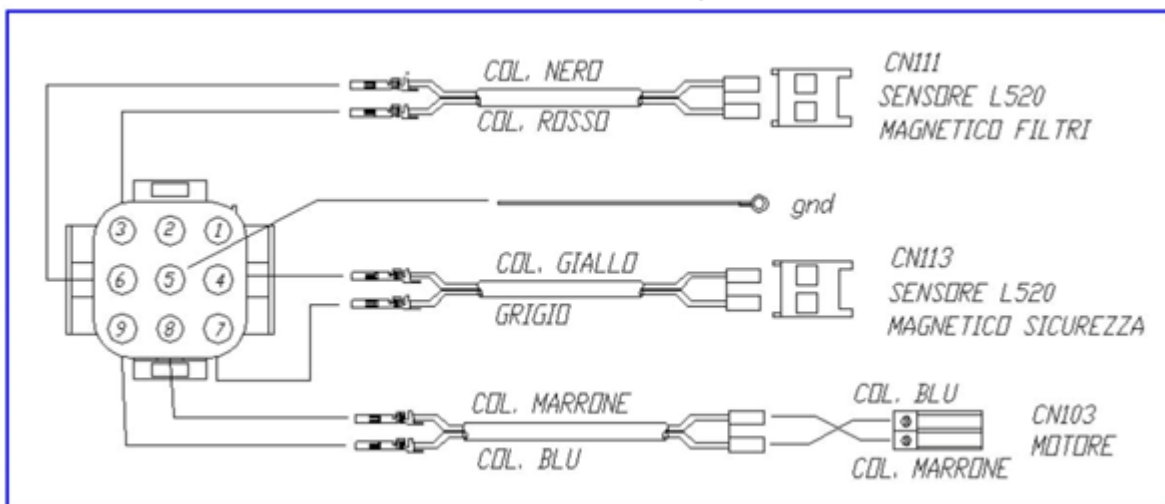

Set the multi-meter in the “Ω” function and place the test probes in the female connector of the downdraft panel into the pins corresponding to the red and black wires of the male connector.

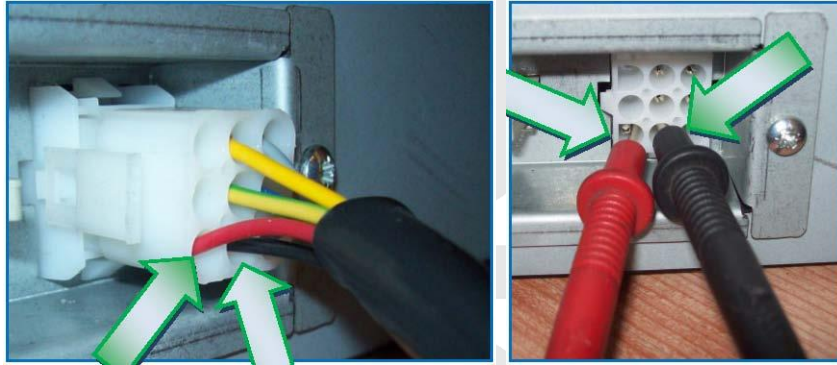

If the multi-meter shows “000” continuity it means that the circuit is closed and the panel is positioned properly.



If the multi-meter shows NO continuity it means that the circuit is open somewhere and the downdraft does not work.



CHECK IF THE PANEL IS UNHOOKED

If the extractable unit is closed and the panel accidentally unhooks, causing the opening of the contact of the filters panel position, it is necessary to hook it again in order to restore operation.

Disconnect the downdraft from the power supply.

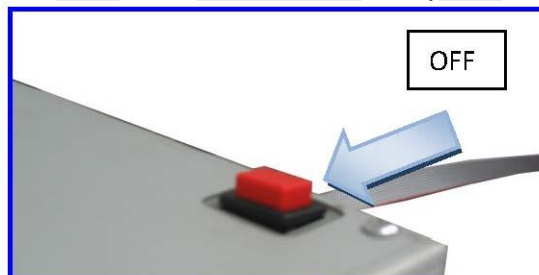

Disconnect all Connections.
Remove the brackets which fix the downdraft to the cabinet.



In case of internal motor version, remove the motor fixing screws and remove the suctioning unit.



In case of external motor version (EM) remove the air-outlet flange.



Lift the downdraft up from the cabinet



Remove the front body panel



Hook it again, by pressing simultaneously on both sides of the panel.



After having remounted the body front panel, and before placing the downdraft again into the cabinet, we recommend checking the downdraft operation.

CHECK IF THE GREASE FILTER PANEL PRESENCE SWITCHES ARE WORKING PROPERLY

If the panel is securely hooked but the continuity test shows that the circuit is open, you need to check the switch conditions.

“The grease filter panel presence switches are placed in the extractable unit, behind the grease filters panel. You need to lift the extractable unit up to check the switch condition and in doing so an electric bridge needs to be made in order to close the circuit.”

CAUTION: BEFORE MAKING THE ELECTRIC BRIDGE AND OPENING THE EXTRACTABLE UNIT, PLEASE MAKE SURE THAT THE PANEL IS HOOKED, OTHERWISE YOU WILL RISK DAMAGING THE COOKER-HOOD IRREPARABLY.

Provide the electrical bridge only if the panel is well hooked and allows the mechanism to slide.

If the panel is unlatched so it does not allow the mechanism to slide do not carry out the electrical bridge.

You need to have an electric wire and by-pass (short-circuit) the red and black wires in the male connector in order to make the electric bridge

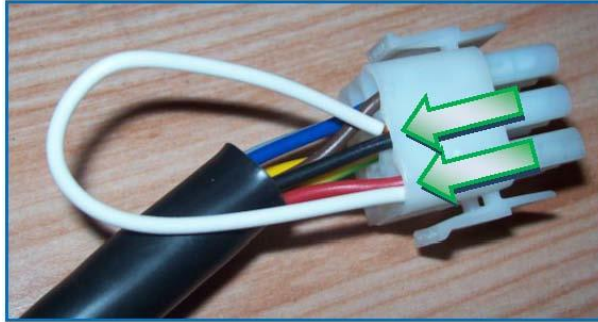

Then connect the connector to the cooker-hood



Check if the other connectors are inserted properly, the red button is in ON position and then push the ON button in the push-button panel.

Lift the extractable downdraft unit up, by pressing the on/off key

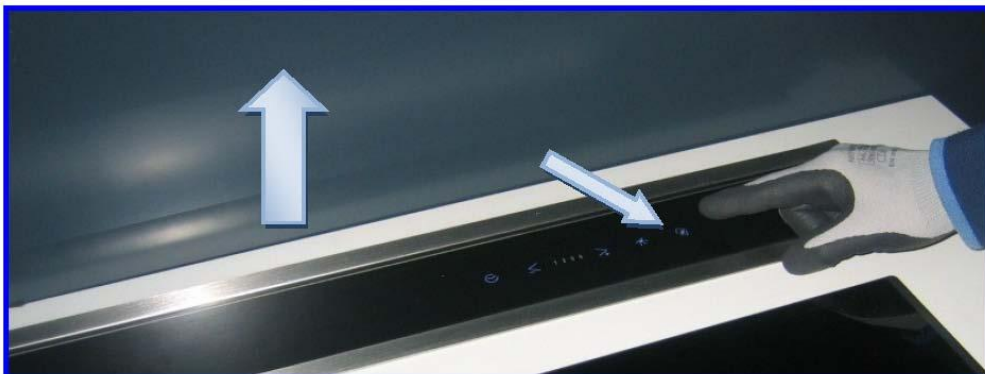

Remove the grease filters covering panel

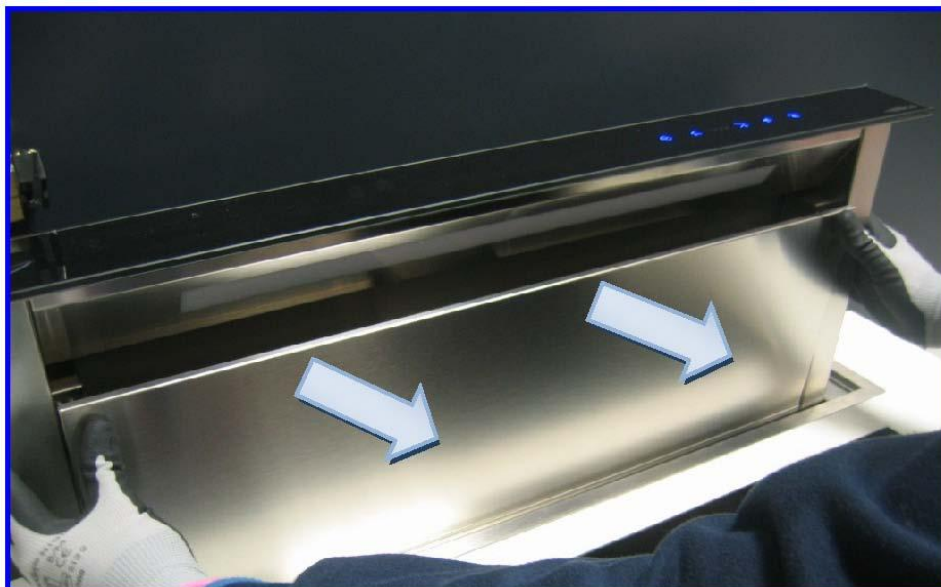

Remove the right and left hinge covers by pulling outwards



By using a multi-meter and in the continuity mode, check if the button is working properly



Button Pressed contact closed



Button Pressed contact released

Check the integrity of the grease filters panel residual circuit.

“If the panel is securely hooked, the buttons are working properly, but the continuity test shows that the circuit is open, the other connections of the circuit itself shall be checked. If the continuity test is performed in the female connector placed in the cooker-hood panel and the circuit turns out to be open, it means that the break is inside the cooker-hood, so you need to check the buttons connections and the red and black wires connection in the 9 pin connector. “

Check the buttons connections:

Lift the extractable unit up by using the shorting link
Remove the upper front as follows: **SDD2-L**

Remove the upper front panel by unscrewing the two socket head screws found on the right and left side of the cooker-hood

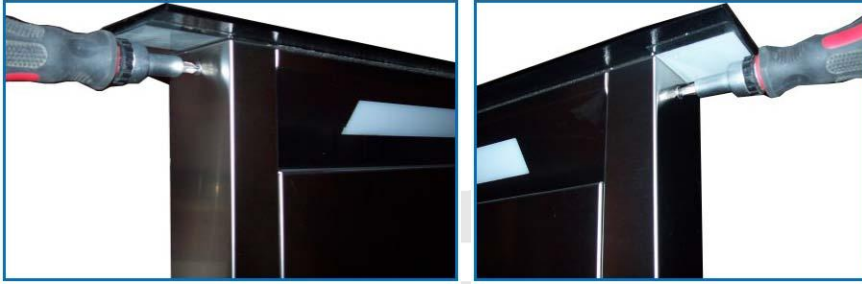

In the model SDD2

Remove the 4 screws and pull the cover out away.

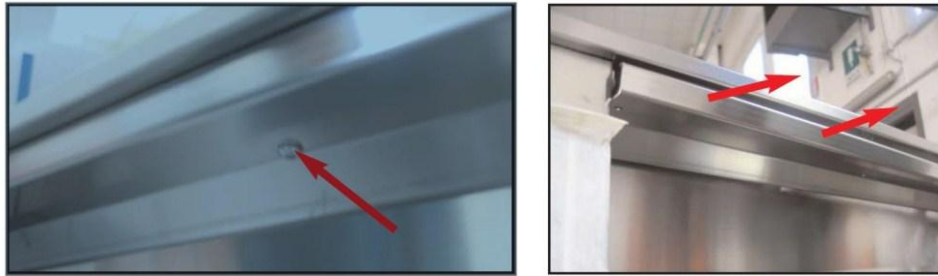

Take the 5 screws underneath and the two side screws out.

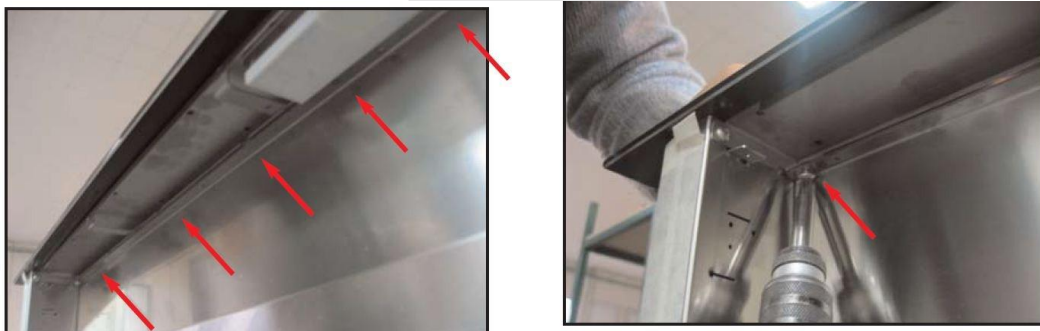

For Both Models:

Lift the front panel up, paying attention to the push button panel flat cable, disconnect the flat connector and remove the front glass panel in order to avoid any possible damage.



Remove the 4 screws in the plastic cover.



Remove the Lid

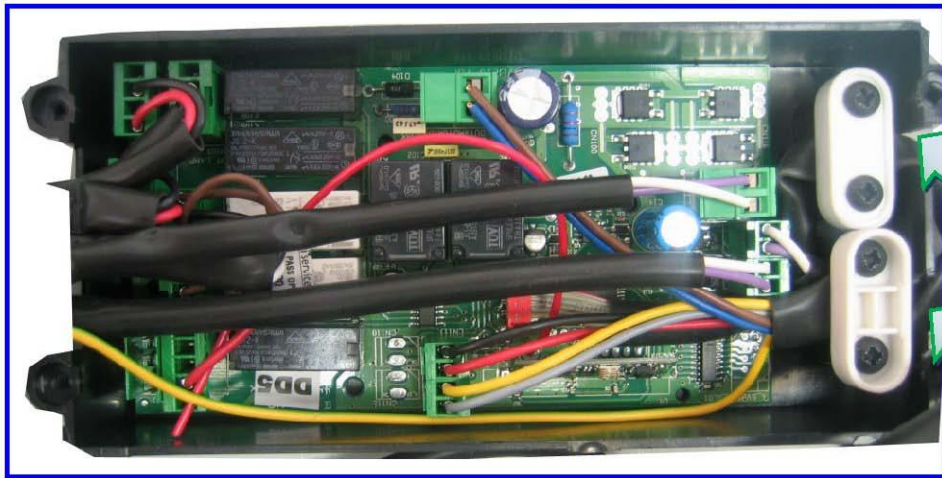

Disconnect one connector at a time **making sure to reconnect them properly** on the new board (use the wiring diagram, or take a photo) For the replacement of the PCB use the spare parts list of the model in question.

CAUTION: PAY ATTENTION TO THE WAY THE CONNECTORS ARE INSERTED

Replace the power supply system board

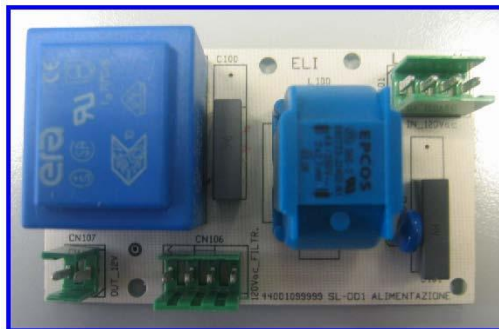

Remove power supply by disconnecting the plug from the mains Remove the control system box cover by unscrewing the 4 screws.



Find the power supply board box.



Disconnect a connector a time **making sure to properly reconnect them in the new board** (use the wiring diagram and figures shown below.)

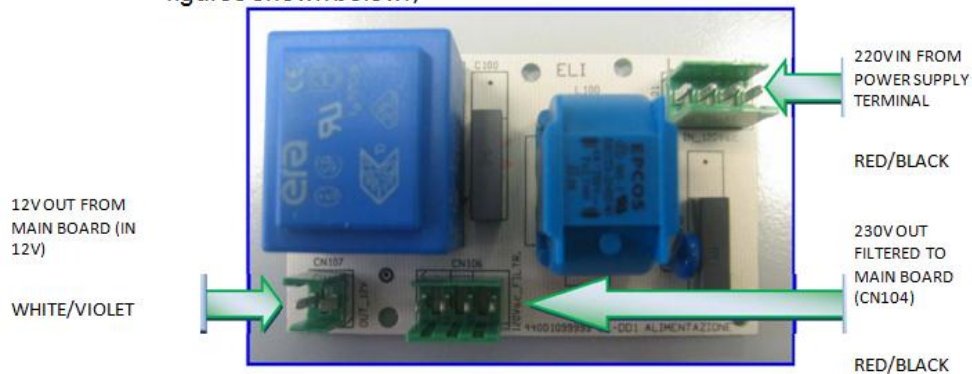

CHECK CONNECTIONS ON THE PUSH-BUTTON PANEL

Check if the grey connector of the push-button panel is inserted properly and if there are any bent pins inside the connector.

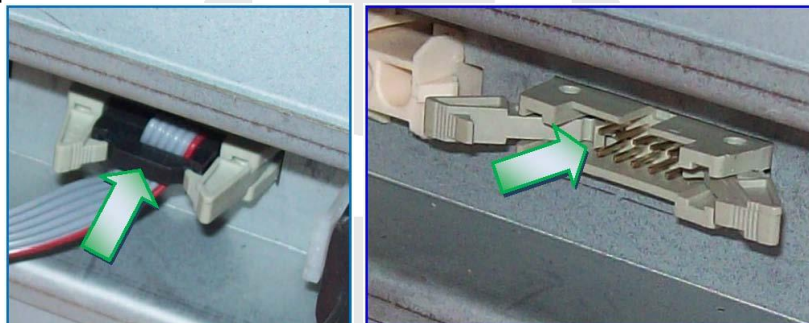

Check if the push-button panel ribbon cable is properly connected to the main board.
Push Connection SDD2 Push Connection SDD2-L



Check if the ribbon cable inside the right column of the extractable unit is properly connected to the connector. You need to remove the upper front side to carry out this operation



REPLACE THE FACIA

"Remove the entire front and replace it with a new one. As for the models THE SDD2 with glass front, replacing the front means the complete keyboard, as glued to the glass itself, while for models with stainless steel front, it is possible to replace only the front.

PROBLEM

2. THE EXTRACTABLE UNIT OPENS AND CLOSES, BUT THE SUCTIONING UNIT DOES NOT WORK AT ANY SPEED

POSSIBLE SOLUTION

Check if the 6 pin connector of the suctioning unit cable is connected properly to the wiring and if all the connector pins are properly inserted into the connector itself.

Check if the connector is inserted properly, pull the sheath outwards and make sure the wires are well inserted into the connectors, according to the colours scheme shown in the figure below.



“It may happen that the connector pins, due to overpressure during their insertion, come out of their seat preventing the electric connection from being performed. With the help of a tool, check if the pins are properly connected.”



CAUTION: BEFORE PERFORMING THIS OPERATION, PLEASE MAKE POWER SUPPLY IS DISCONNECTED



Check if the 6 pin connector wiring of the motor unit in the main electrical system board are connected properly and all the pins of the green connector inside the board are inserted properly.

For internal motor version, check the connections accordingly to the diagram

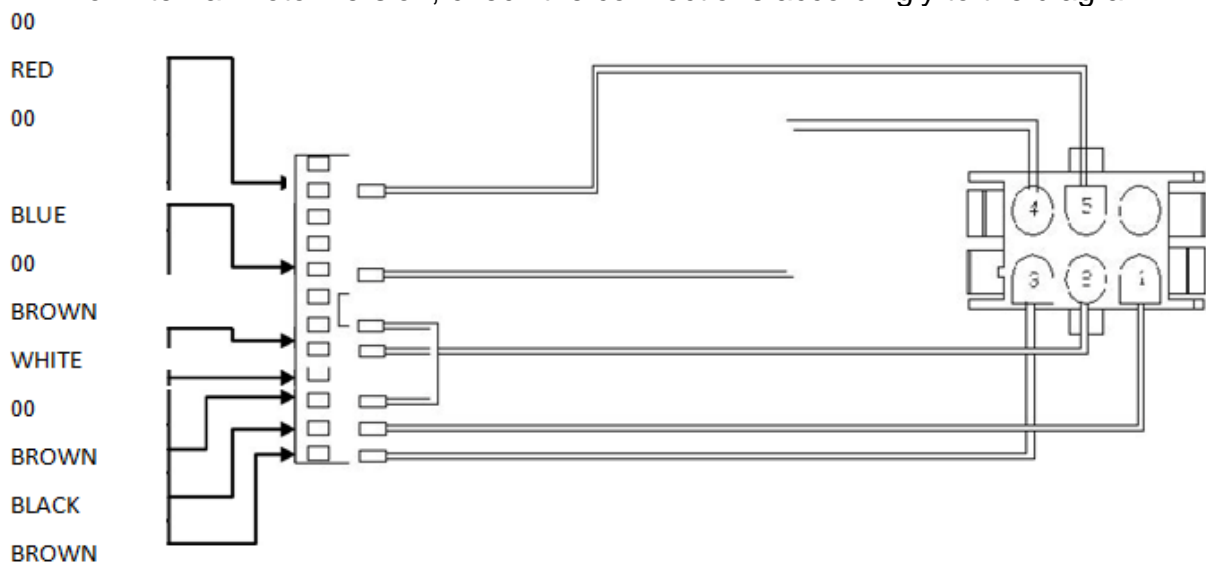

For external motor (EM) version, check the connections accordingly to the following diagram

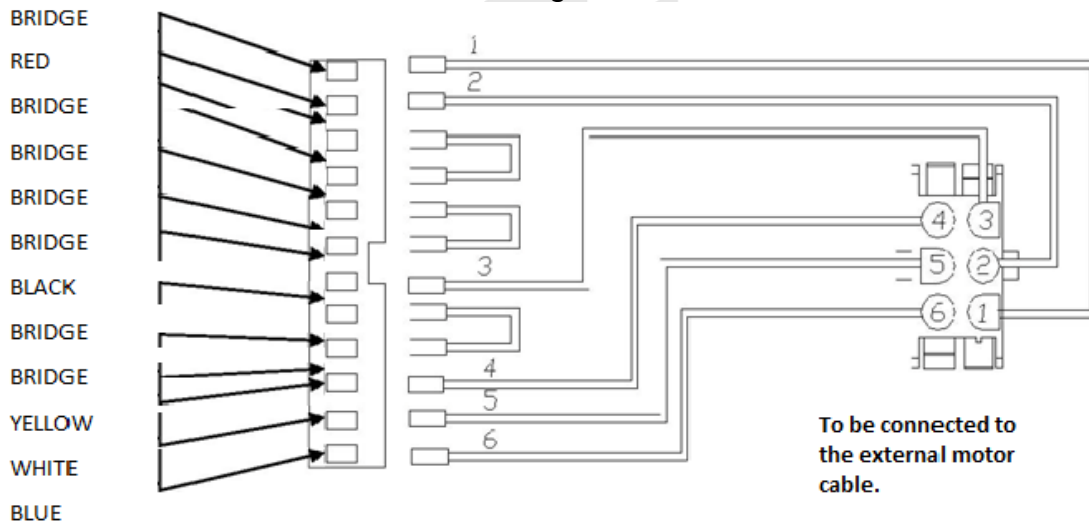

IF CONNECTION WITH EXTERNAL MOTOR MAKE SURE THE 7 METRE UMBILICAL CABLE THAT CONNECTS THE HOOD WITH MOTOR OUTSIDE IS NOT CUT OR TAMPERED WITH"

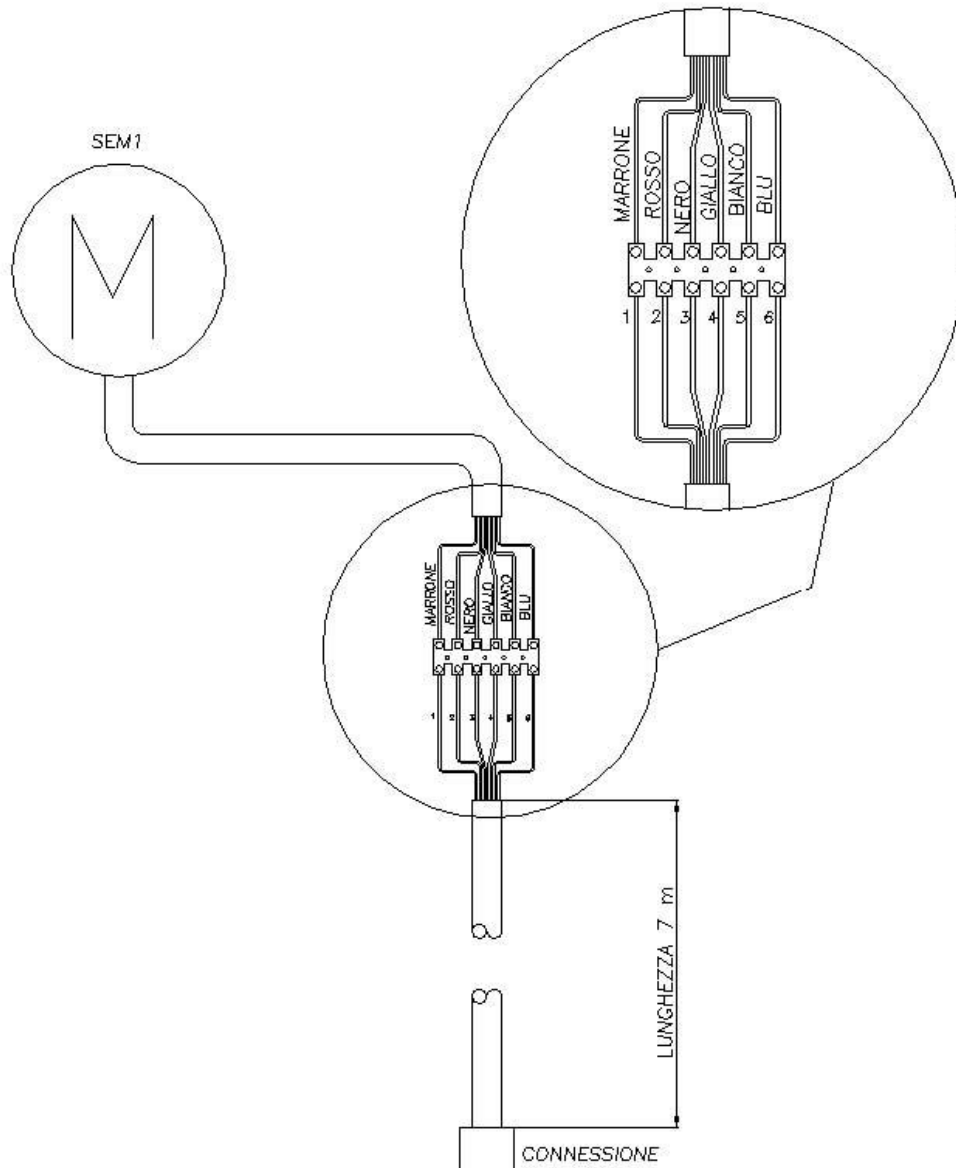

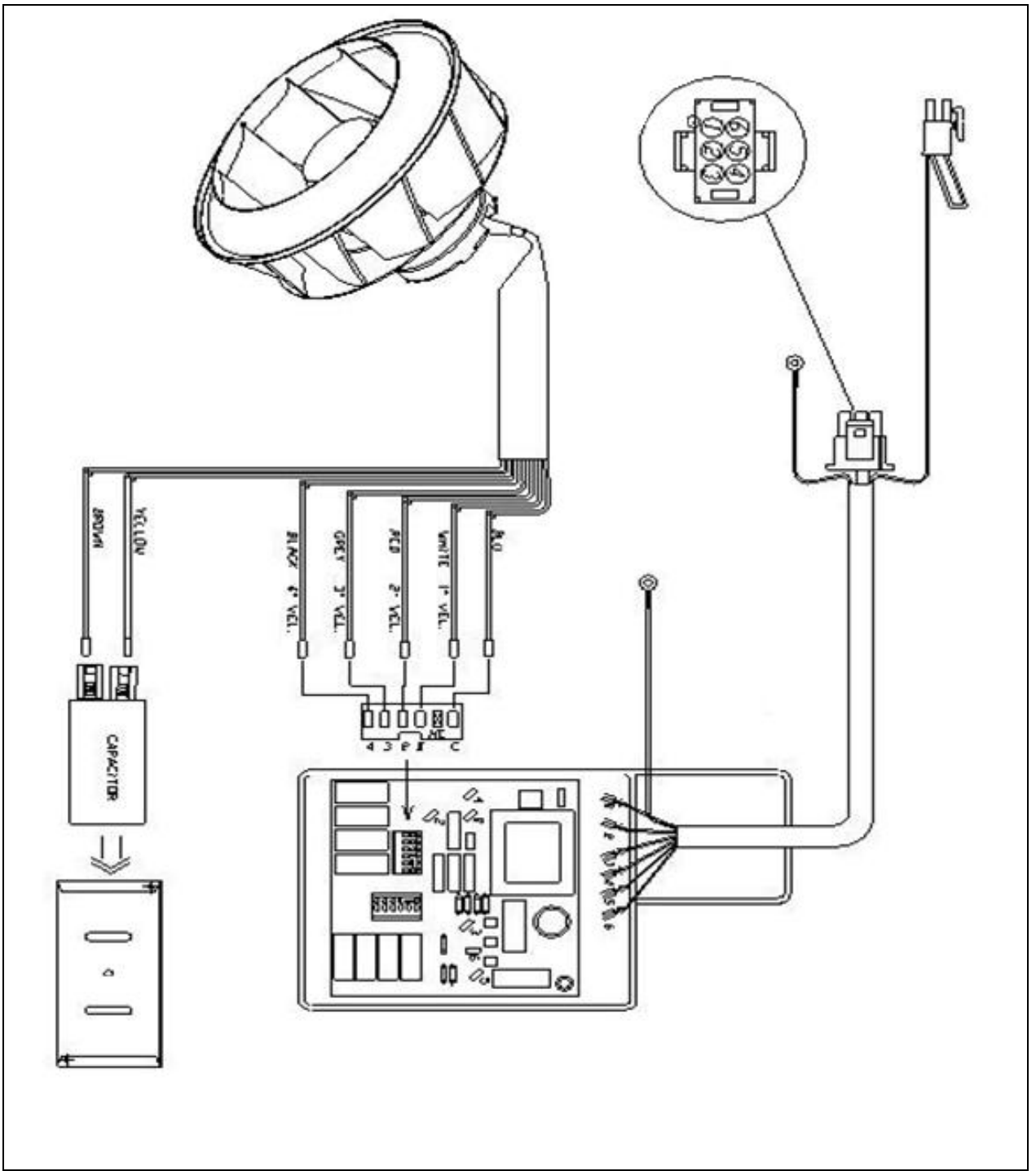

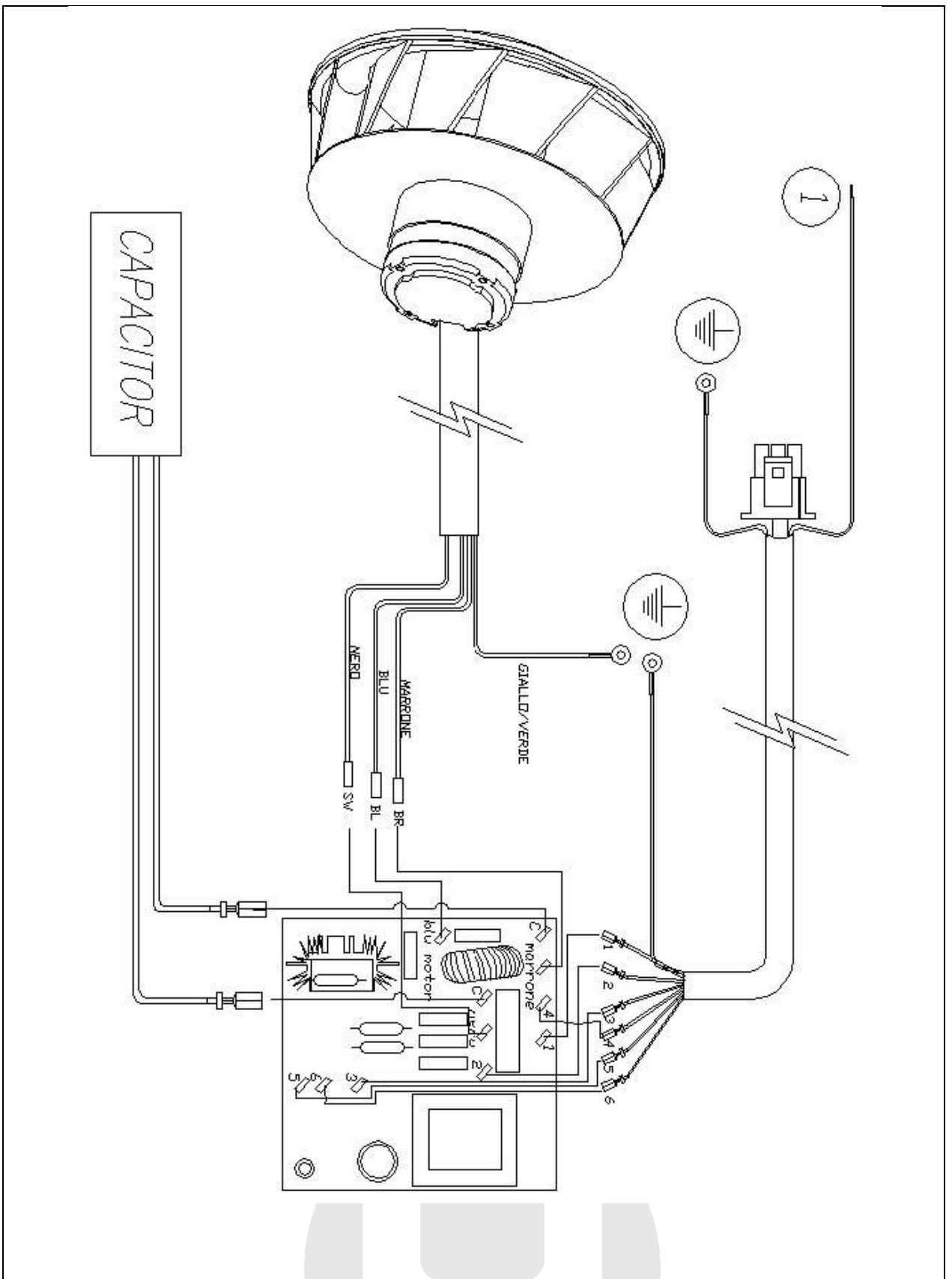

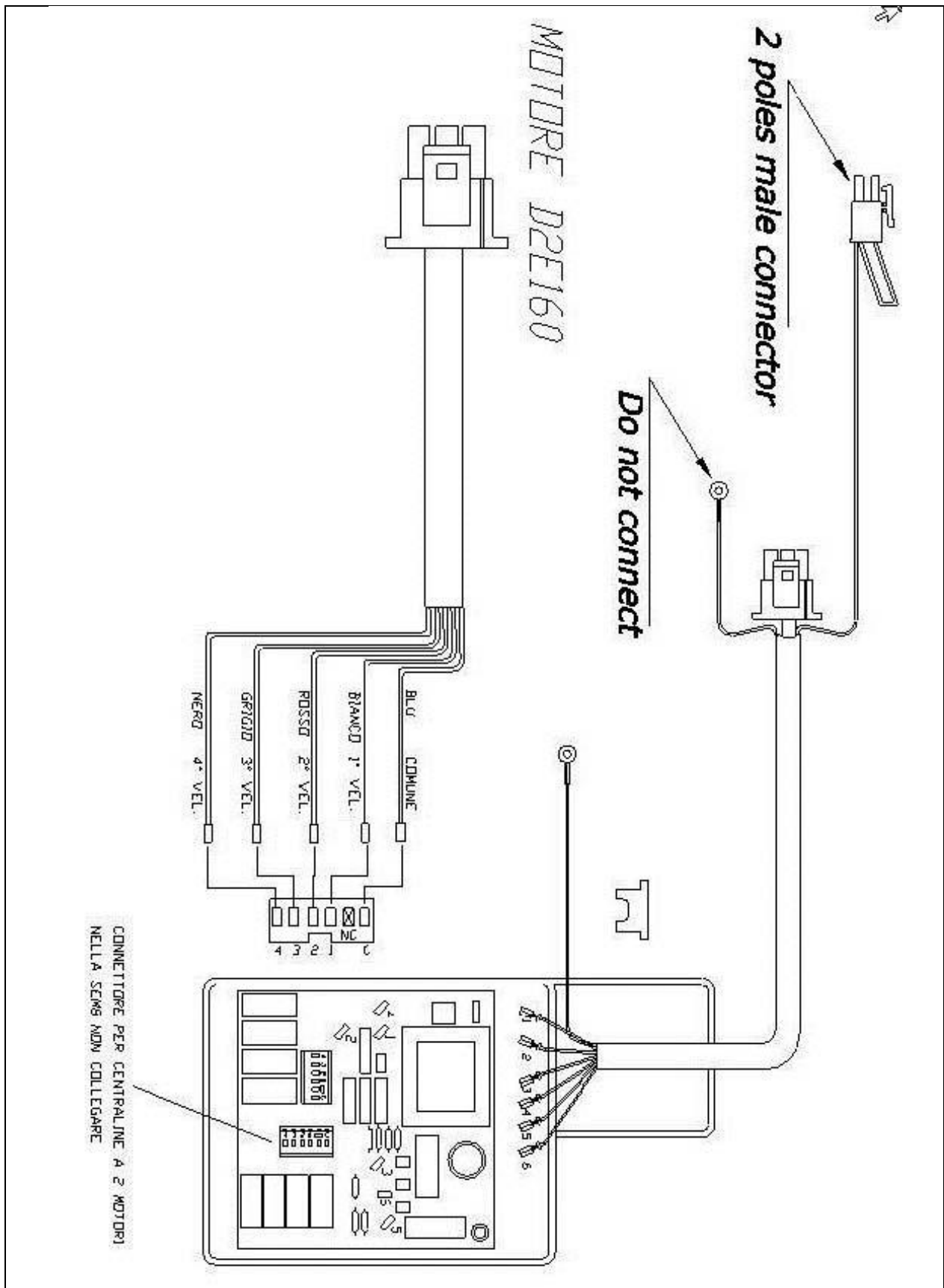

Check if the 6 pin connector of the suctioning unit is connected properly and if all the pins of the connector are properly inserted inside the connector itself.

Remove the motor assembly from the downdraft, by unscrewing the 8 M4 screws
“To perform this operation you only need to remove the suctioning unit; in case it is not possible please remove the entire box of the suctioning unit assembly”

If it is possible to remove only the suctioning unit, unscrew the 10 top screws that secure the unit and remove it.

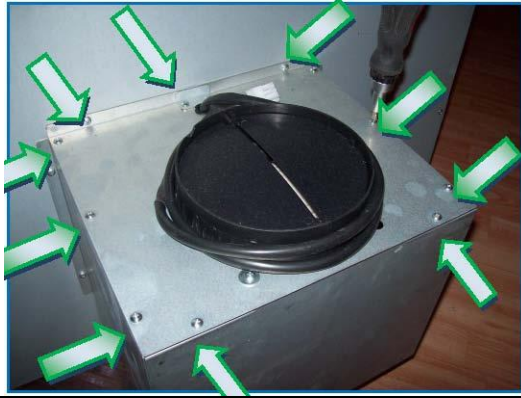

Check if the connector is inserted properly, pull the sheath outwards and make sure the wires are well inserted into the connectors, according to the colours scheme shown in the figure below.

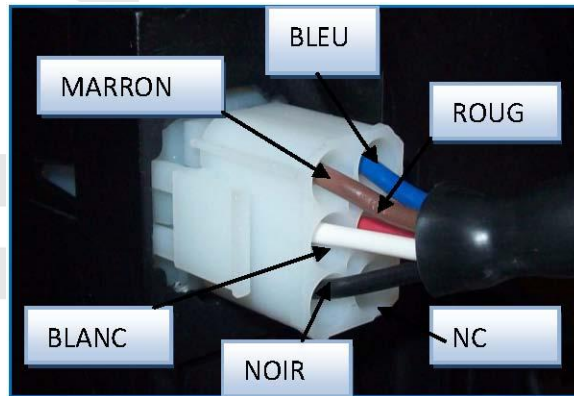

If it is not possible to remove the unit being the downdraft already fitted into the cabinet, you need to remove the entire suctioning unit box, by unscrewing the 8 screws which secure it to the body.



Then remove the unit as previously shown.

CHECK IF THE RELAYS INSIDE THE BOARD SWITCH OVER PROPERLY WITH PRESSURE OF SPEED CHANGE FROM THE PUSH-BUTTON PANEL.

Make sure there is power and the red button is pressed.

Press the speed variation + and – key.

Open the electric system box and check if the motor relays are switching over.

“When pressing the speed variation key a “CLICK” should be heard ”



Replace the main electric system board
Replace the suctioning unit



Disconnect the connector.

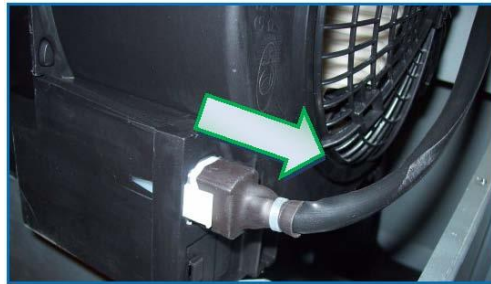

Unscrew the two safety screws of the suctioning unit.



Push the air out-let side tongues of the suctioning unit and pull it downwards.



Replace the suctioning unit with a new one of the same kind (see the spare parts list).

PROBLEM

3. THE STAINLESS STEEL BODY LINER IS DAMAGED

REPLACE THE BODY LINER

Disconnect the downdraft from power supply

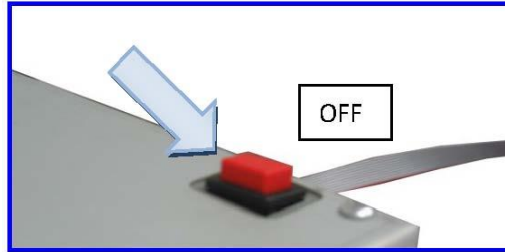

Remove the brackets which fix the downdraft to the cabinet



In case of internal motor version, remove the motor fixing screws and remove the suctioning unit.



In case of external motor version (EM) remove the air-outlet flange.



Lift the downdraft up from the cabinet



Reconnect the connectors and raise the unit Remove the upper front Disconnect the the cable strap



On the back and side remove the screws that hold the edge carcass.

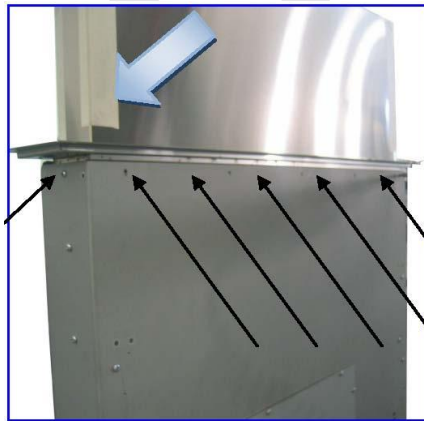

Before removing the body liner from the extractable unit, we recommend to use protective adhesive strips in order to avoid the extractable unit getting scratched
Note: There are two type of edge casing standard one and that FLUSH TOP, first to remove the edge casing make sure the spare is correct. For both models:

Remove the body liner.



PROBLEM 4.
THE SUCTIONING SYSTEM WORKS PROPERLY BUT THE
EXTRACTABLE UNIT DOES NOT OPEN

POSSIBLE SOLUTION
CHECK IF THE ELECTRICAL SYSTEM CONNECTORS ARE CONNECTED
PROPERLY

Disconnect the downdraft from power supply

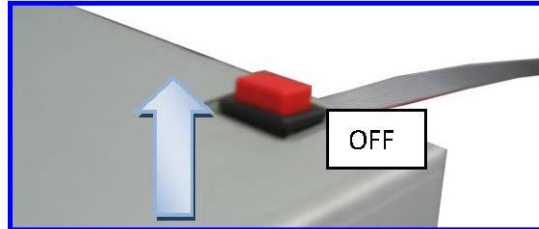

Check if the 9-pin connector male and female contacts are connected properly.



Release the movable connector wires by removing the black sheath.



Check if the connector inner contacts are inserted properly, with the help of a screwdriver. Carry out this check in both the movable and the fixed connectors.

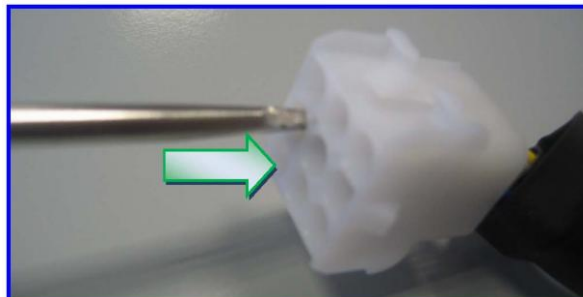

Check connections according to the wiring diagram are inserted properly.

Actuator

- PIN 9 BROWN COLOUR
- PIN 8 BLUE COLOUR

Check if the blue and brown wires of the connector on the control system board are connected properly.

(Caution: There are about 12V in the connector during the actuator rise. The 12 V will disappear if you disconnect the connector, since the board does not recognize the actuator presence. Therefore, DO NOT perform any tension measurement if the actuator is not connected.)

OPERATOR FROM POWER
CONNECTOR 9 POLES BLUE /
BROWN

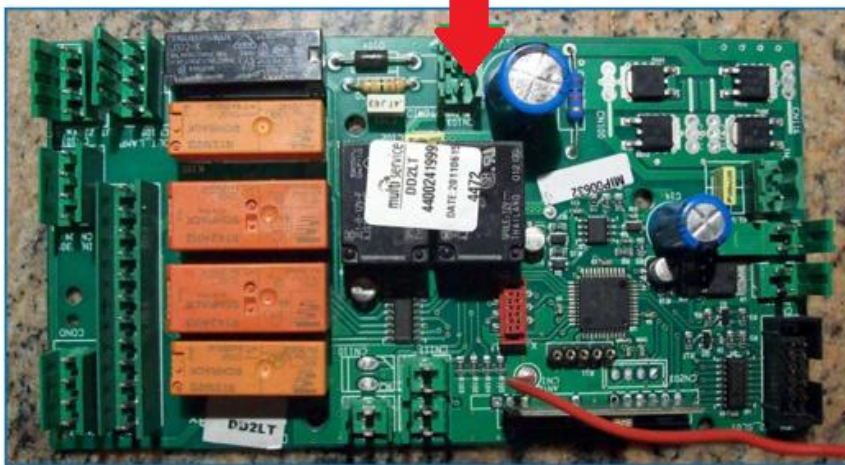

Check the internal connection of the actuator

Remove the motor unit, remove the downdraft from the cabinet if necessary.



Find the actuator connection in the right side opening of the downdraft unit.

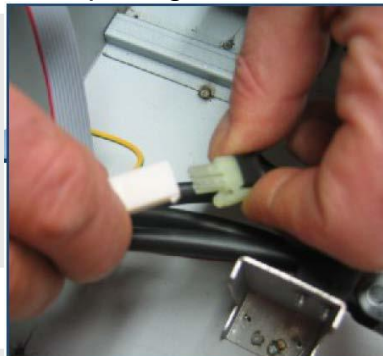

Check if the 2-pole connector (blue and brown wires) for the actuator feeding is inserted properly and the pins inside the connector are crimped properly.

CHECK IF THE ELECTRO-MECHANICAL TRANSFORMER PLACED INSIDE THE

ELECTRIC SYSTEM BOX IS WORKING PROPERLY

Remove the electrical system box cover.



Find the electro-mechanical transformer



Remove the terminal box protection by unscrewing the two screws.



Check if there are 220V in the transformer primary and about 12V in the transformer secondary.

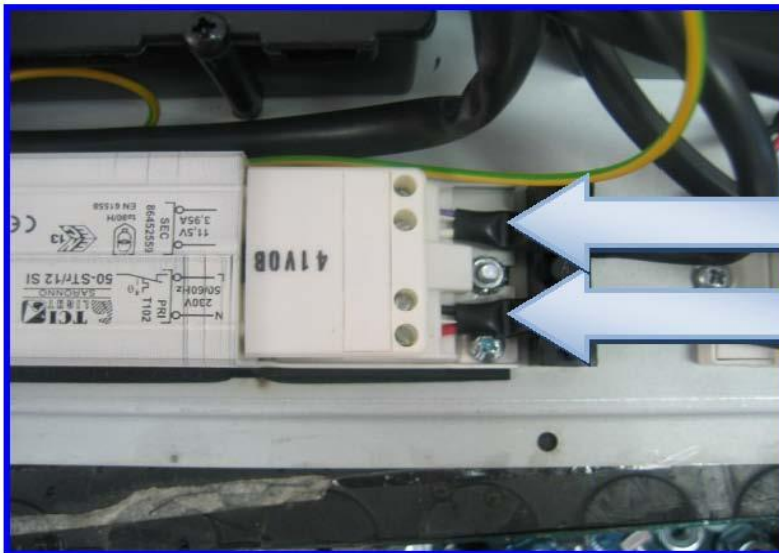

220Volts
AC

12 Volts AC

About 12 V should be found also in the CN102 board connector

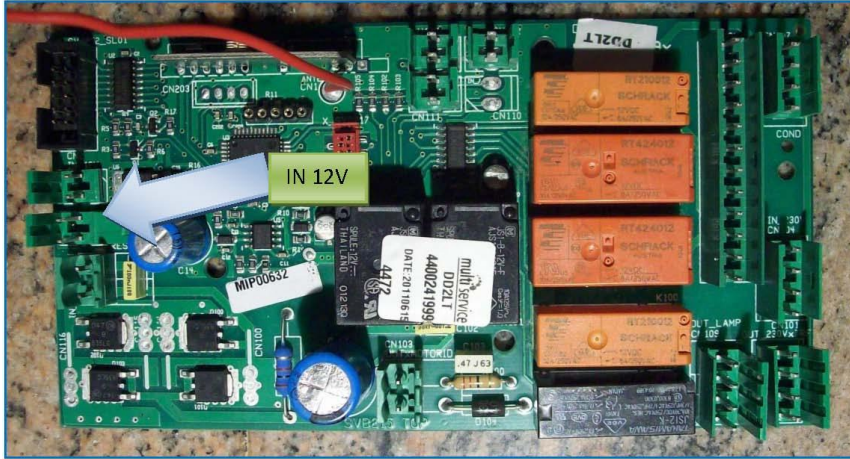

Replace the actuator

Disconnect power supply remove the 9-pin connector in the motor unit



Dismount the suctioning unit, by taking the no.8 screws (A) out.



Disconnect all connectors

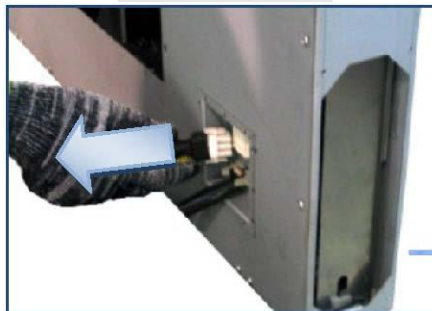

Remove the panel (A) from the body

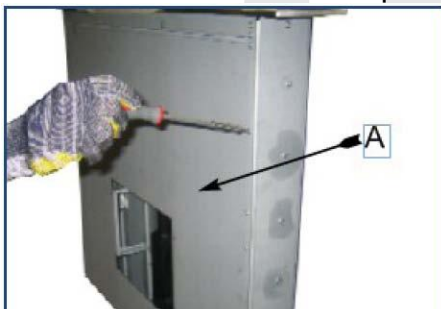

Remove the actuator connection covering, by taking the three screws (A-B-C) out

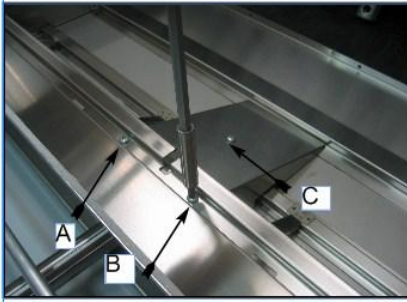

Remove the lower side actuator screw by using two 17 mm keys



Disconnect the actuator from the extractable unit by taking the M8 screw (A) out, using two 17 mm spanners.

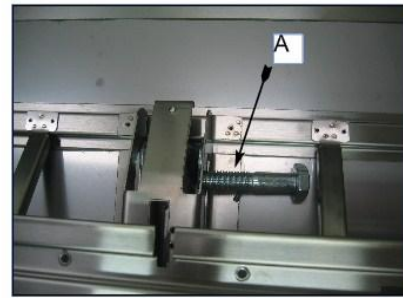

Remove the actuator from the lower side of the downdraft

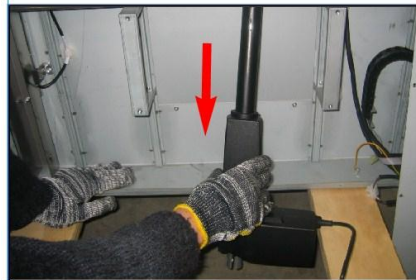

Replace the old actuator with a new one, reconnect the electrical connections.

PROBLEM 5

THE EXTRACTABLE UNIT RE-OPENS BY ITSELF DURING AND AFTER ITS CLOSING

POSSIBLE SOLUTION

CHECK IF THE SAFETY SENSOR IS WORKING PROPERLY

(The DOWNDRAFT is equipped with a safety sensor which changes the extractable unit direction if an obstacle is met during its closing. The sensor is a magnetic contact which is normally open and closes when the magnet, placed on top of the actuator, is placed in front of the sensor due to the obstacle.)

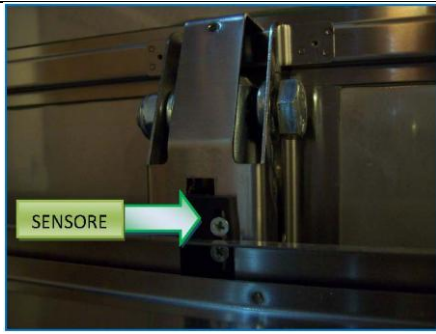

To check the sensor proper working, you need to place the tester rods at the Yellow and Grey wires of the 9-pin fixed connector. If the sensor works properly the tester should show an open circuit

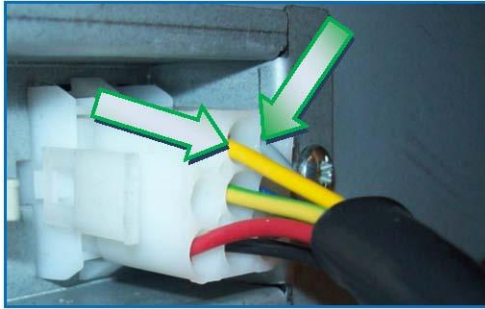

Open the front panel to make sure the sensor is not damaged,

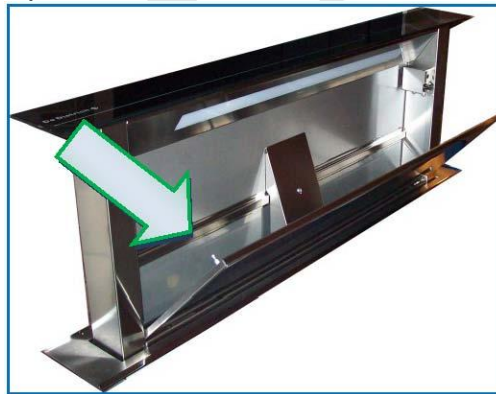

Remount the actuator covering, using (A) (B) (C) screws

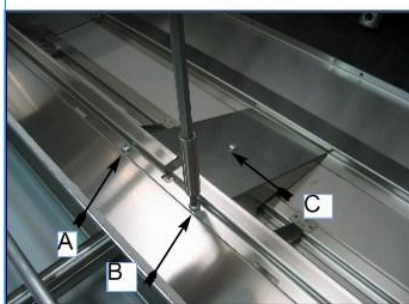

Take a magnet and place it close to the sensor , then repeat the test using a tester: the circuit should be closed at this point
If without the use of the magnet, the circuit is closed, carry a screwdriver -head screwdriver and move the position of the sensor down.

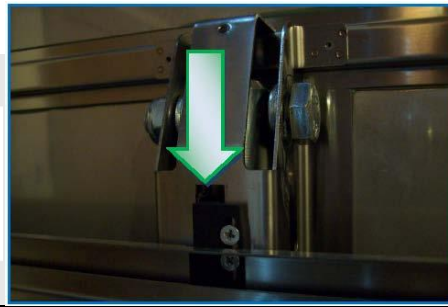

If the circuit is still closed after having moved the sensor, you need to replace the sensor. Unscrew the two screws, cut all of the sensor cable fixing clamps and remove the sensor by pulling it from the bottom

(Since the magnet shall be placed in the same position of the damaged one, carefully check the cable, clamps and sensor position before removing the magnet.)



Then cut the sensor cable and replace it with a new one, soldering the wires and insulating the joints.



Refit the sensor in its downwards position and the cable fixing clamps as well.

CARRY OUT THE CALIBRATION RESET. (SOLO SDD2-L)

(The DOWNDRAFT sdd2-l has a setting device placed inside the electronic board which adjusts the actuator effort during rising and falling. This setting is performed automatically every 3 complete opening and closing cycles of the extractable unit. It may happen that this setting is not performed properly during the automatic calibration procedure, due to some problems with the software)

To carry out the calibration reset you need to press the timer key 6 times consecutively, (about 2 seconds should pass between one press and the other)
The reset has been performed successfully if all of the speed indicators flash at the sixth press

CALIBRATION only applies to DOWNDRAFT MODEL SDD2

After having installed the downdraft and after having connected it to the mains supply, press the red button on the wiring box and run the calibration as follows:
Press the ON/1 button (S-DD2) or the ON/+ (S-DD2TC) the aspiration panel rises.
After it has reached a height of 18Cm from the cook top, press the ON/1 button (S-DD2) or the OFF button (S-DD2TC) to stop the extraction. Then press Timer and after 2 seconds the OFF button (S-DD2TC) button. The downdraft will carry out the calibration rising and retracting for some centimetres. During this phase, the buttons on the push-button control panel blink. At the end of the calibration, let the extractable unit goes down pressing the OFF button.

PROBLEM 6

THE PUSH BUTTON PANEL DOESN'T LIGHT UP

POSSIBLE SOLUTION

CHECK IF THE PUSH-BUTTON CONNECTOR IS CONNECTED PROPERLY



Take the right and left mini-latch cover off, by pulling it outwards.



Remove the 4 screws of the lower cover and take the cover off by pulling it outwards



Take the under head 5 screws and the two lateral screws out

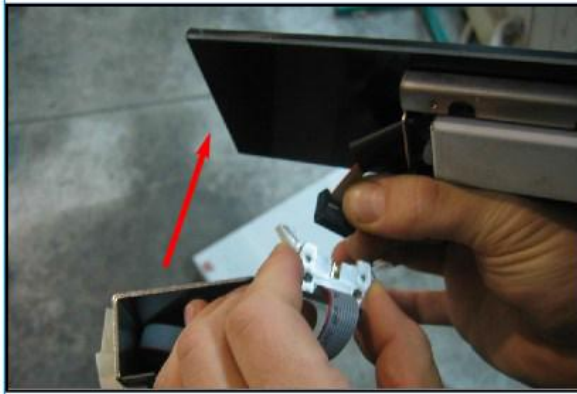

Lift the front panel up and disconnect the connector; then remove the front panel.

Replace the front panel with the new push-button

**FOR PUSH-BUTTON IN A STAINLESS STEEL FRONT PANEL ,
AFTER HAVING REMOVED THE STAINLESS STEEL FRONT PANEL,
FOLLOW THE STEPS BELOW:**

- Remove the upper front panel as shown in previous Chapters.
- The push-button panel that CAPLE supplies as a spare part is equipped with a Ribbon cable and a connector (A)



Unscrew the two threaded dowels (A) and (B) to the right and left of the push-button panel.

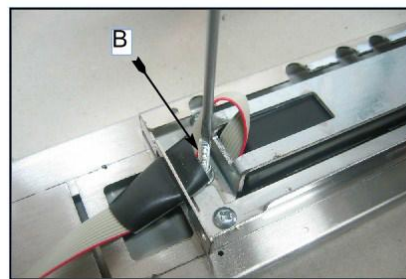
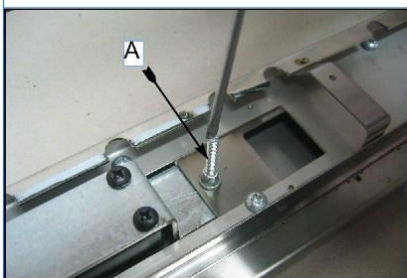

Place the front panel in vertical position, apply a light pressure on the keys and take the push-button panel out.

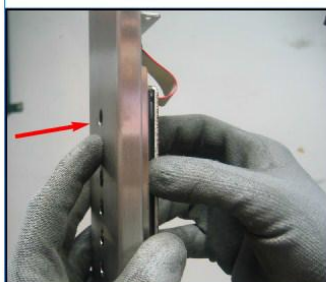

Remove the metal support , taking out the n°3 self-tapping screws which hold the push-button panel

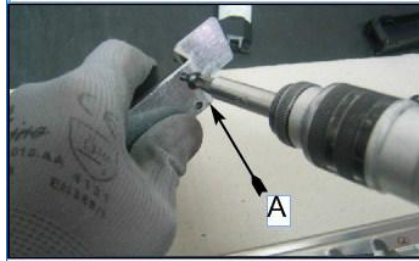

Then, if the push-button panel to be replace cannot be reused, it is possible to cut the Ribbon cable in order to make the push-button panel removal easier..

Note: Keep the protection black sheath (A) of the damaged push-button panel

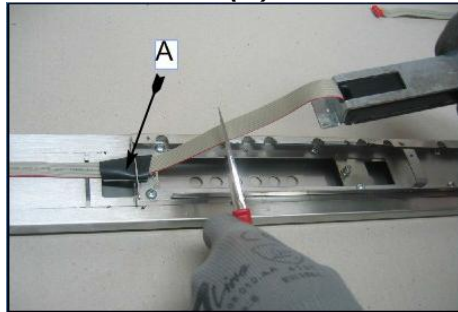

Take a new push-button panel and break the plastic piece shown in figure (A)

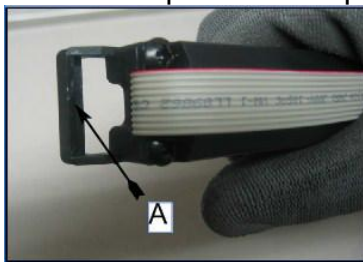

Protect the keys with adhesive paper , if possible



Open the push-button and disconnect its Ribbon cable (A)

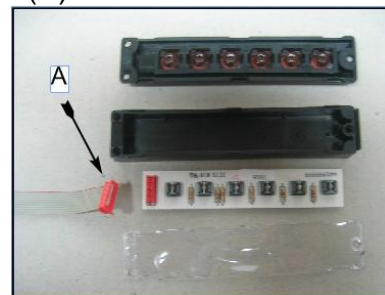

Insert the Ribbon cable from the red connector side, inside of the push-button seat buttonhole, keeping its pins oriented upwards.



Take the black sheath previously removed from the flat and put it in the new push-button Ribbon cable (A)

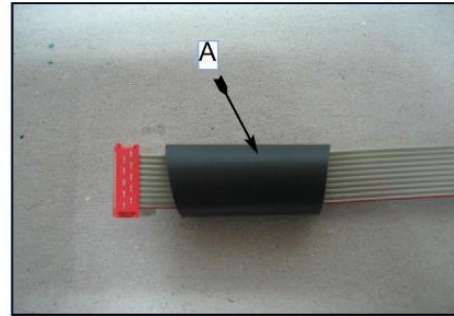
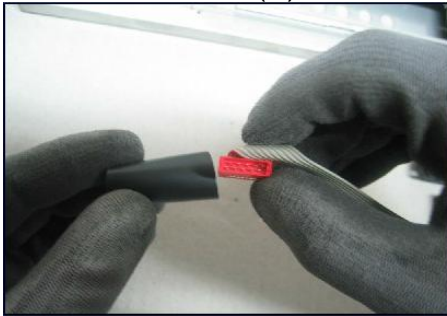

Insert the Ribbon cable onto the bracket (A)

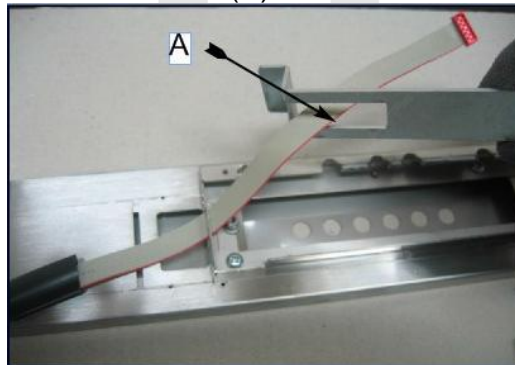

Connect the Ribbon cable to the control board, making sure to fix it properly

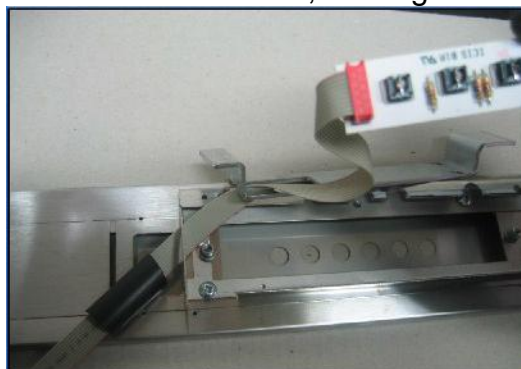

Then, fix the lower side of the push-button box to the metal bracket.



Place the control terminal board inside the plastic box.



Close the control box, making sure that keys are positioned properly

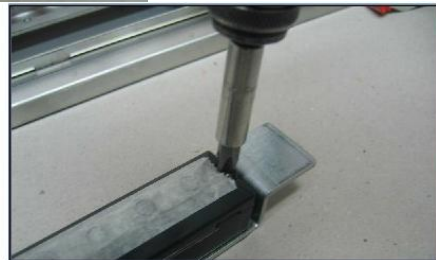

Remove the protective film.



Reinsert the push-button bracket inside the upper front panel.

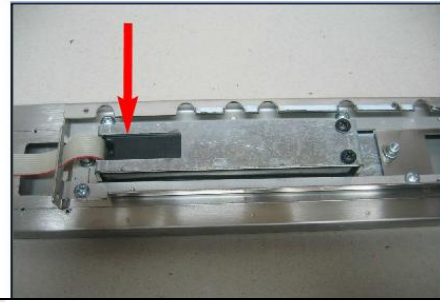
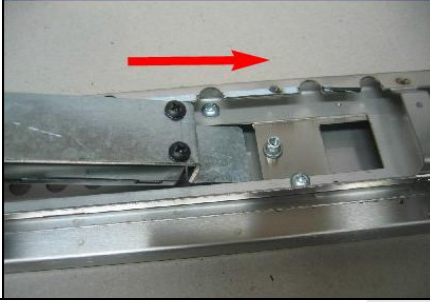

Place the sheath between the flat and the sheet piece of the front panel (A)

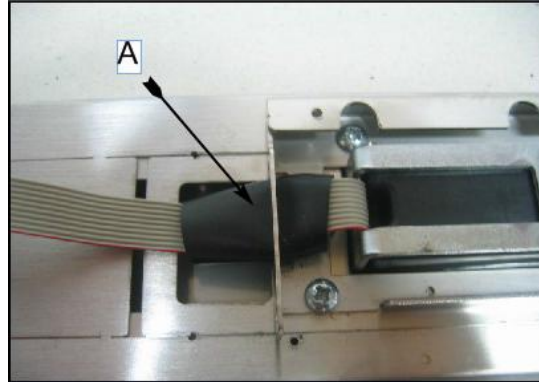

Fix the push-button with the M4 (A) dowels

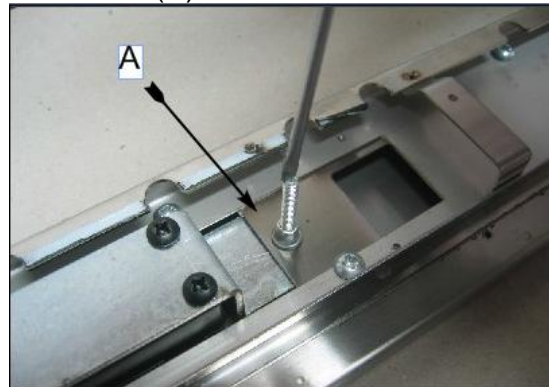

Check if keys have been inserted properly..

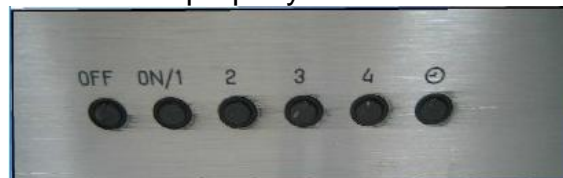

Remount the upper front panel.

To replace the control panel in the case of sdd2 - L front INOX , proceed as follows :

Unscrew the two dowels which fix the push-button bracket.



Remove the push-button support



Remove the push-button stainless steel cover



Remove the push-button panel and replace it with a new one, remount the push-button cover, the push-button bracket and related connections.

PROBLEM 7
APPLIANCE DOES NOT LIGHT UP

POSSIBLE SOLUTION

REPLACE THE NEON LAMP (TUBE)

Raise the carriage by pressing the ON button and then remove the mains power.



Remove the upper front panel

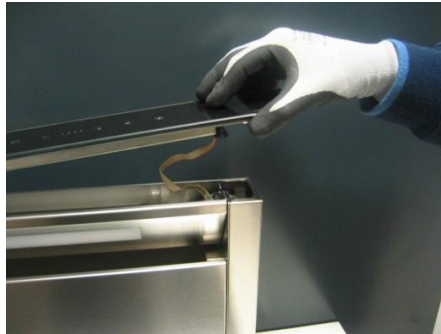

Disconnect the Ribbon cable

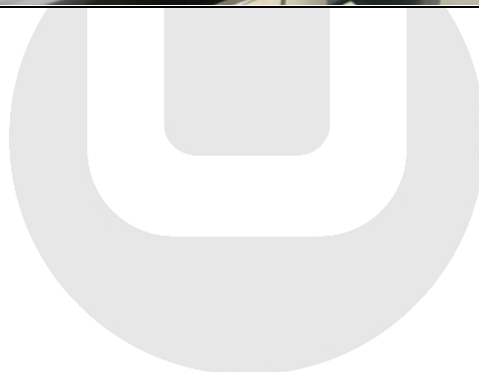
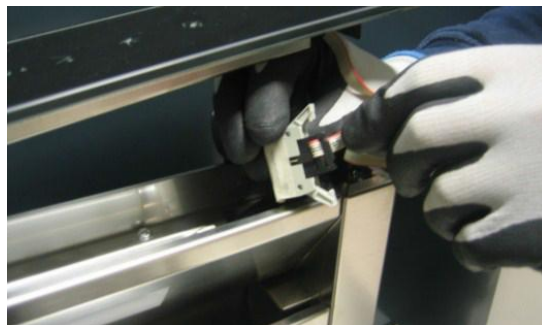

Remove the neon tube and replace it with a new one.

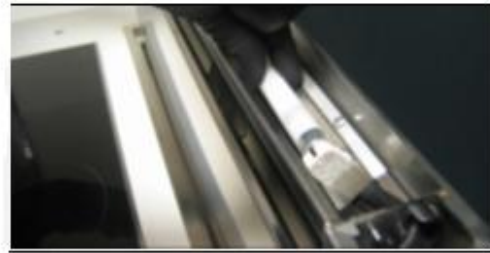
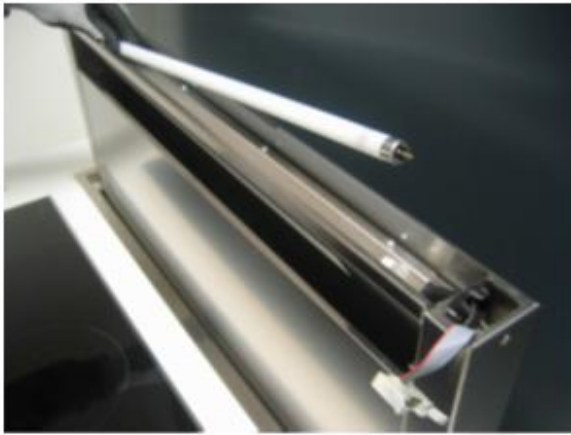

Remount the upper front panel and reconnect the Ribbon cable; then check the neon tube operation.

CHECK THAT THE NEON TUBE SUPPORTS ARE NOT DAMAGED AND ARE CONNECTED PROPERLY.

Unscrew the neon tube support by removing its screws

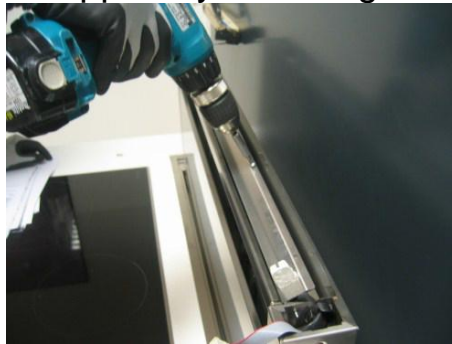

Check if wires inside the neon tube holders contacts are inserted properly

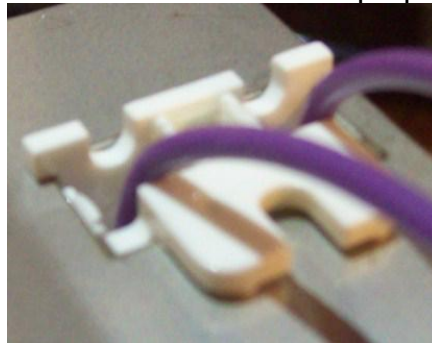
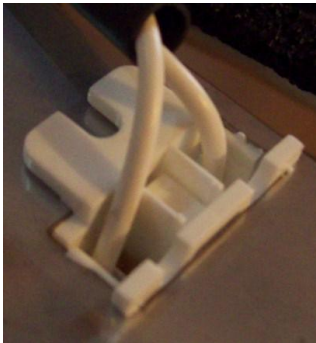

Carry out an electric continuity test between the neon tube holders and the ballast inside the electrical system box.

Place a test probe in one of the neon tube holder's contacts and check the ballast continuity inside the electric system box.

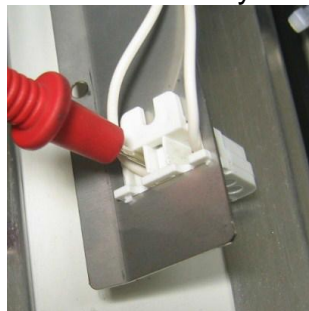

Carry out the same test in all the four ballast prods.

REPLACE THE NEON TUBE SUPPORTS

If one of the neon tube supports is broken , replace it with a new one

Disconnect power supply, and the wires on the neon tube holder to be replaced.

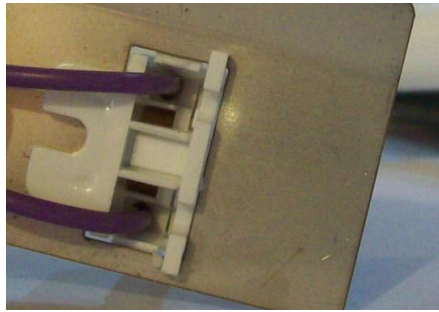

Push the tongues placed in the upper side of the neon tube holder and remove the component by moving it downwards.

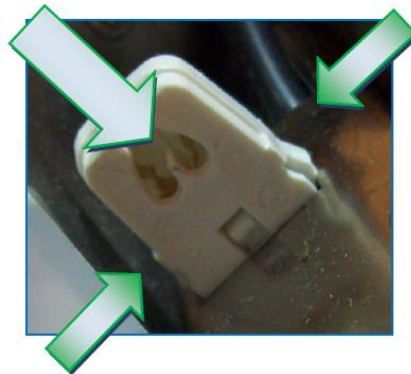

CHECK IF THE STARTER INPUT VOLTAGE IS 230V

CAUTION: THIS OPERATION SHOULD BE PERFORMED WITH THE APPLIANCE CONNECTED TO POWER SUPPLY

Lift the extractable unit up and press the light key

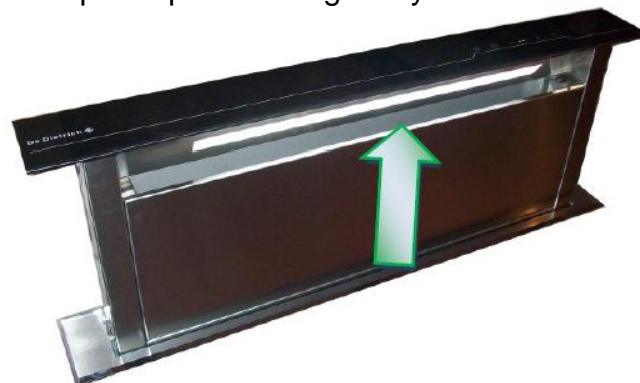

Remove the Control system box cover by unscrewing its 4 screws.



Find the neon tubes Starter



Place the test probes at the ballast input and check if there is 230V.



REPLACE THE STARTER

Disconnect power supply, by removing the plug from the electrical network or by opening the magneto-thermal switch if present.

Disconnect the Starter wires by using a screwdriver and by pushing on the side shown in the figure

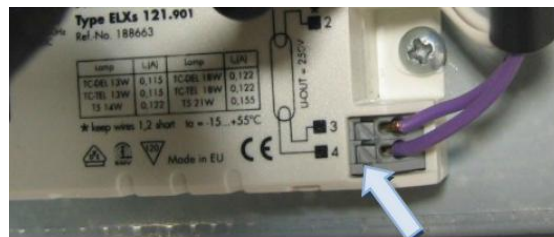

PROBLEM 8.

THE FILTERS ALARM SIGNAL AFTER 30 HOURS WORKING DOES NOT RESET WHEN PRESSING THE TIMER BUTTON

POSSIBLE SOLUTION

DISCONNECT AND RESTORE POWER SUPPLY

Press the reset key and then disconnect the appliance from power supply.

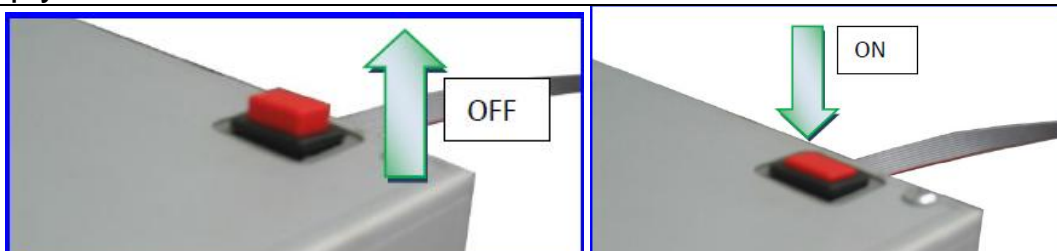

Check the Ribbon cable in the Main control box

PROBLEM 9.

THE DOWNDRAFT AIR-CAPACITY IS INADEQUATE

CHECK THE DUCT LENGTH

In order to assure good air capacity performance, the downdraft air-outlet pipe should be as shorter as possible and the number of elbows should be limited as much as possible: we recommend not to exceed 5 linear meters piping.

CHECK THE AIR OUTLET PIPE SECTION

The air-outlet pipe section must have a constant diameter of 150mm for its whole length. In case a flat piping is used, its section should always be the same as the 150 mm pipe at least

MAKE SURE THERE ARE NO OBSTRUCTIONS ALONG THE PIPE

The piping should be free in all of its length and the grid used as terminal should allow the air out-let (AVOID to use too close grids preventing the air out-let) both in suctioning and filtering mode. The air shall flow freely without any obstacles

CHECK IF THE CHARCOAL FILTERS ARE STILL IN GOOD CONDITIONS IN CASE OF FILTERING VERSION

In case of filtering version, check if the charcoal filters inside the downdraft are in good condition; if not, replace them with new ones. Charcoal filters shall be replaced every six months at least.

CHECK IF THE NON-RETURN VALVE TONGUES CAN MOVE FREELY.

The suctioning unit has some non-return tongues placed on its air out-let, so that air cannot come back into the room from the cooker-hood in case of wind. When performing the pipe connection, make sure that no screws are used which may block the valves.



PROBLEM 10.

THE EXTRACTABLE UNIT OPENS, BUT IT DOES NOT STOP WHEN REQUIRED, AFTER 180 mm, AND THE SUCTIONING SYSTEM WORKS WHEN THE EXTRACTABLE UNIT IS COMPLETELY OPEN, AND STOPS WHEN THE EXTRACTABLE UNIT IS COMPLETELY CLOSED. (SOLO PER MODELLO SDD2)

CHECK IF THE 180MM SENSOR IS WORKING PROPERLY

Take the black sheath out in the 9 pole movable connector coming from the electric system box.

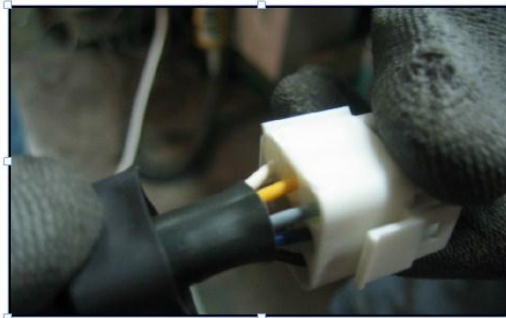

- With the help of a multi meter, place the probes into the pins corresponding to.
- violet (2) and
- white (1) colour

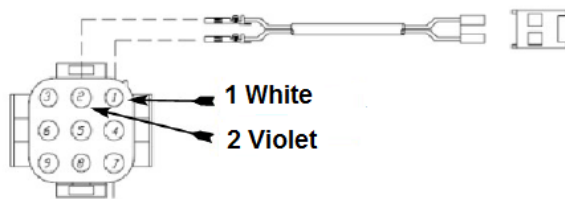

Power the downdraft and activate the ON function

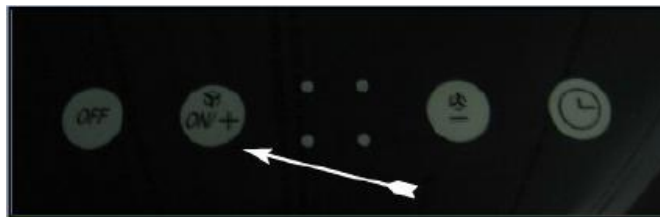

If the sensor is working properly, when the extractable unit reaches 180 mm of height in the multi meter, some seconds of electric continuity must be noticed. If there is no electric continuity, check if the magnet (A) in the extractable unit column is placed properly.



REPLACE THE 180MM SENSOR

Disconnect power supply

Dismount the body panel (A)

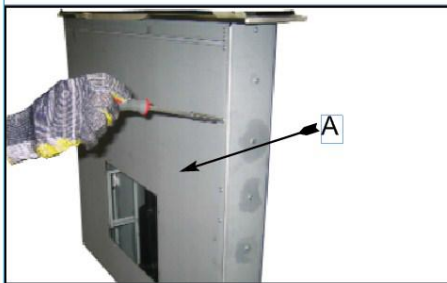

Remove the 180mm sensor fixing screws



Cut the wires of the sensor and replace with a new one

