



CE902WH

Caple Ceiling extractor



Technical information



CE902WH

Caple Ceiling extractor

21-5-2015

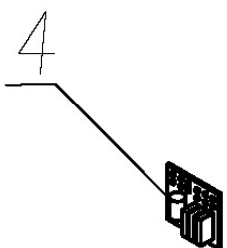
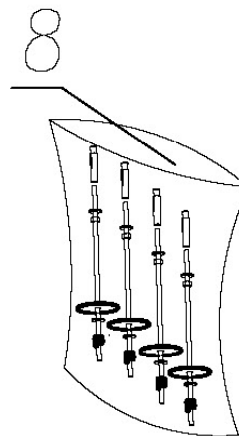
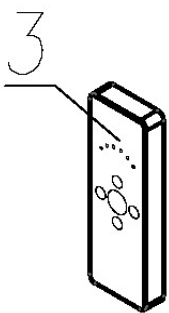
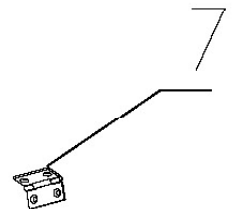
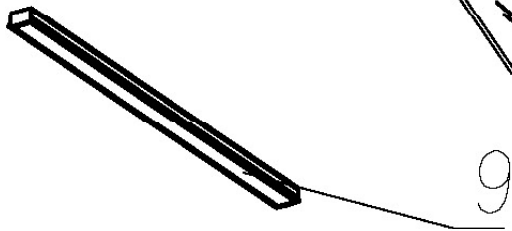
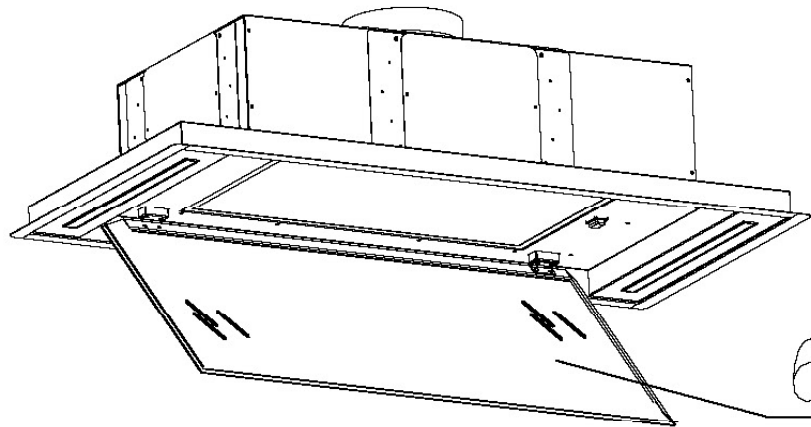
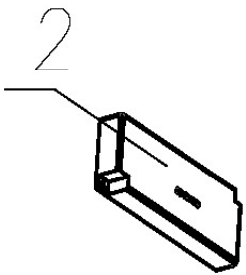
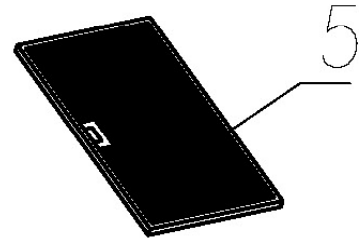
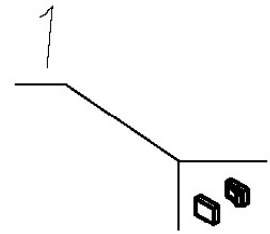



CE902WH - Caple Ceiling extractor

Item	Part Code	Description	Qty
1	75470199999	EMERGENCY SWITCH/START NEON	1
2	75007026320	TRANSFORMER DC 12V EFU 122320	1
3	75470140400	REMOTE CONTROL	1
4	75007096681	main print SLT/ED EL	1
5	75002400480	GREASE FILTER	1
6	75095841154	S958WH PANEL	1
7	75096003003	FLAT MILLED HINGE	1
8	75095003950	FIXING KIT	1
9	75002400326	Led strip 4200°K 320mm 6.5W	1