



ST523

Caple Storm Built Under Hood



Technical Manual

ST523 - Caple Storm Built Under Hood

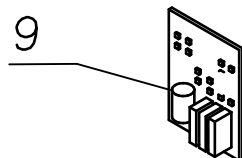
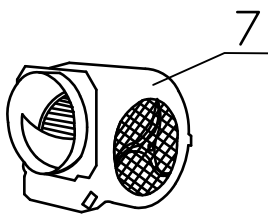
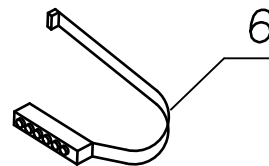
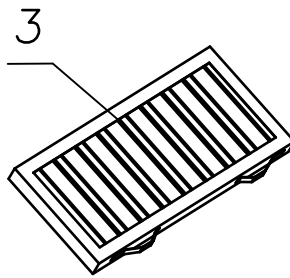
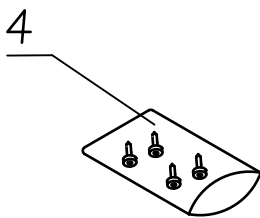
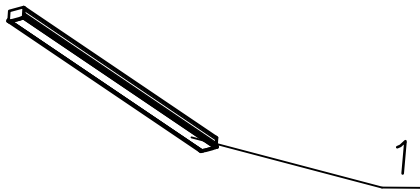
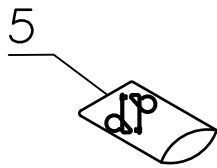
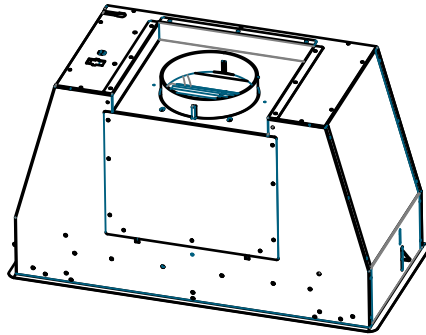
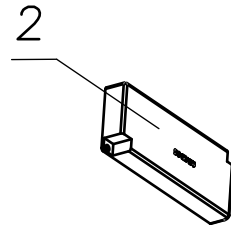
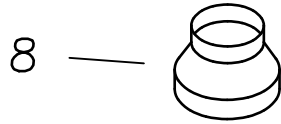



ST523 - Caple Storm Built Under Hood

Position	Part Number	Description	Quantity
1	75002400326	LED STRIP 4200°K 320mm 6.5W	1
2	75007026320	TRANSFORMER DC 12V EFU 122320	1
3	75071906520	STAINLESS STEEL FILTER	1
4	75042906181	BUILT-IN HOOD ACCESSORIES	1
5	75042906095	SPRING	1
6	75042906167	CHROMED VERTICAL BUTTONS	1
7	75061500099	MOTOR	1
8	75070404028	REDUCTION FLANGE 150/125	1
9	75085404041	MAIN PCB	1