



ST522

Caple Storm 522 Built Under Hood



Technical information



ST522

Caple Storm 522 Built Under Hood

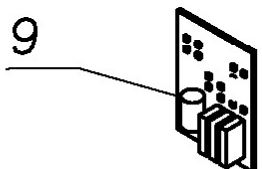
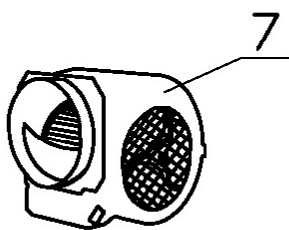
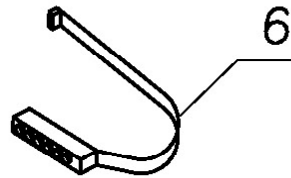
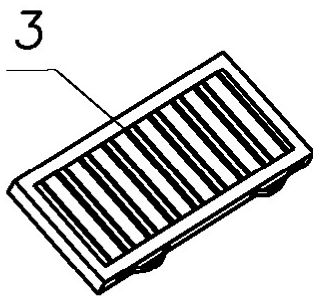
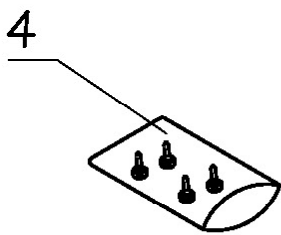
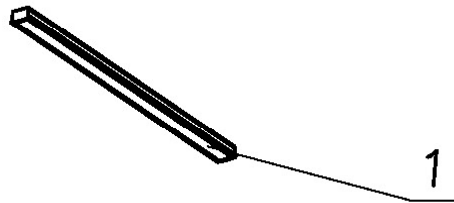
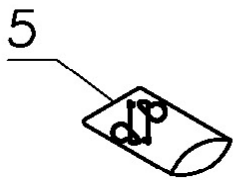
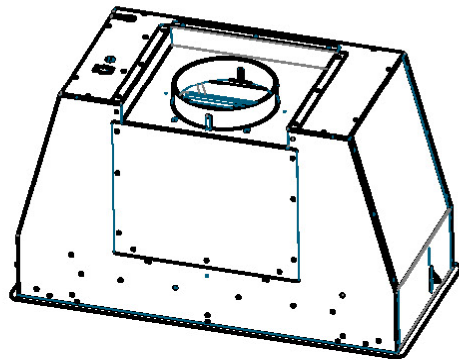
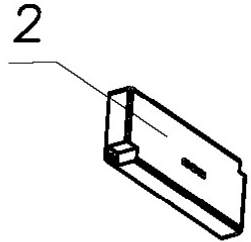
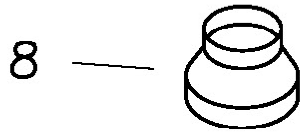



ST522 - Caple Storm 522 B-Under Hood

Item	Part Code	Description	Qty
1	75002400326	LED STRIP 320mm 6.5W	1
2	75007026320	TRANSFORMER DC 12V EFU 122320	1
3	75071906520	STAINLESS STEEL BUFFLER FILTER S906 520	1
4	75042906181	BUILT-IN HOOD ACCESSORIES	1
5	75042906095	SPRING	1
6	75042906167	CHROMED VERTICAL BUTTONS	1
7	75061500999	PLASTIC MOTOR 800 E. LA.	1
8	75070404028	REDUCTION FLANGE 150/125	1
9	75085404041	MAIN PRINT EL SL/E	1