



# ST521

Caple Storm Built-Under Hood



Technical information



# ST521

Caple Storm Built-Under Hood

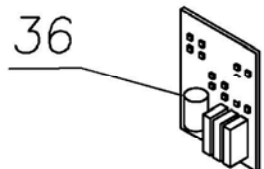
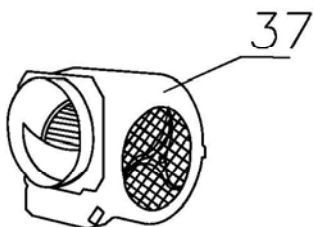
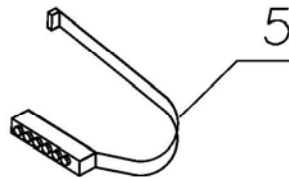
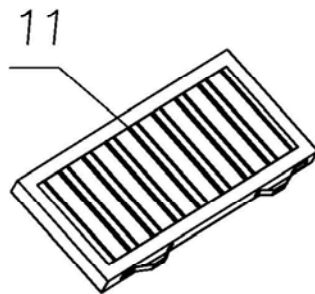
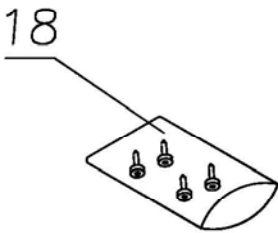
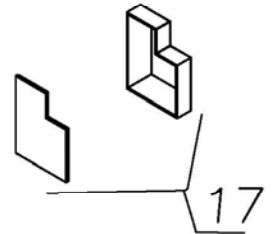
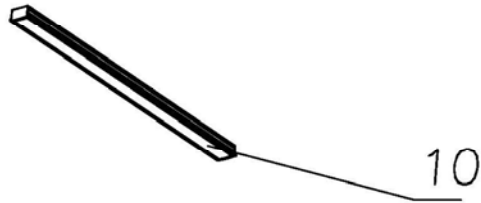
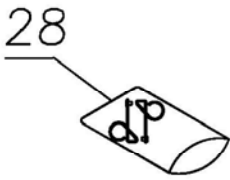
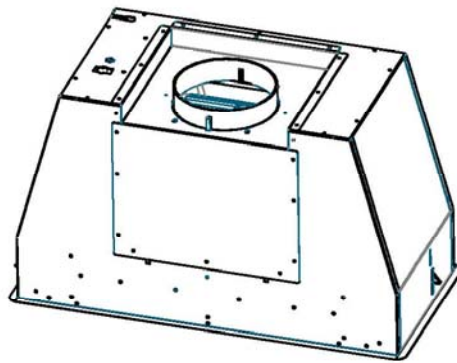
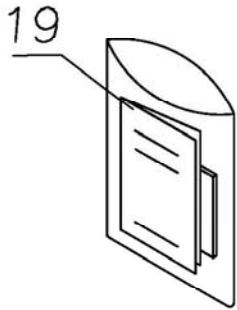
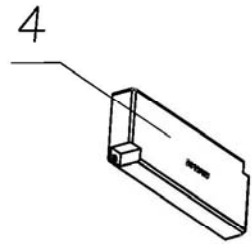



## ST521 - Caple Storm hood

Item	Part Code	Description	Qty
4	42030122320	TRANSFORMER EL. DC 12V EFU 122320	1
5	77041679999	VERTICAL CHROMED PUSH-BUTTON	1
10	42010320010	LED 320mm (Before Jun-14)	1
10	42010320006	LED 320mm (From Jun-14)	1
11	75071906520	ASS. R. FILTRO BUFFLER S906 520	1
14	51071000399	REDUCTION FLANGE 150/125 AE	1
17	75071439999	WIRING BOX SET	1
18	77008199999	ACCESSORIES BAG FOR BUIL-IN	1
19	90001120020	LIBR. ISTR. S906L CAPLE	1
28	77009599999	SPRINGS FOR BUILT-IN COOKER-HOODS	1
36	44000419999	WIRING BOARD TYPE SL/E	1
37	75061509999	MOTOR GPZ900	1

# ST521

Caple Storm Built-Under Hood

