

## Instruction manual for slot-in wine cabinet

Model code: WI152



Contact Caple on 0844 800 3830 or for spare parts [www.4caple.co.uk](http://www.4caple.co.uk)

## WARNING

- To prevent damaging the door gasket, make sure to have the door all the way open when pulling shelves out of the rail compartment.
- The appliance must be positioned so that the plug is accessible. Release the electric cord and move your cabinet to its final location. Do not move your Cabinet while loaded with wine. You might distort the body. The wine cellar should be installed in a suitable place in order to avoid touching the compressor with the hand.
- If the supply cord is damaged, it must be replaced by a Caple service agent or a similarly qualified person in order to avoid a hazard.  
**PLEASE DON'T TRY TO EXTEND THE ELECTRICAL CABLE IN ANY WAY.**

## IMPORTANT SAFETY INSTRUCTIONS

<b>⚡WARNING⚡</b>	To reduce the risk of fire, electrical shock, or injury when using your appliance, follow these basic precautions:
<ul style="list-style-type: none"><li>• Read all instructions before using the Wine cabinet.</li><li>• <b>DANGER or WARNING:</b> Risk of child entrapment. Child entrapment and suffocation are not problems of the past. Junked or abandoned appliances are still dangerous . . . even if they will “just sit in the garage a few days”.</li><li>• <b>Before you throw away your old Wine cabinet:</b> Take off the door, leave the shelves in place so that children cannot easily climb inside.</li><li>• Never allow children to operate, play with, or crawl inside the appliance.</li><li>• Never clean appliance parts with flammable fluids. The fumes can create a fire hazard or explosion.</li><li>• Do not store or use gasoline or any other flammable vapours and liquids in the vicinity of this or any other appliance. The fumes can create a fire hazard or explosion.</li><li>• <b>The refrigerant of these appliances are R600a , Flammable and explosive articles should not be put in or near the cabinet, to avoid the risk of fire or explosion.</b></li></ul> <p style="text-align: center;">-Keep these instructions-</p>	

## INSTALLATION INSTRUCTIONS

### ➤ **Before Using Your Wine cabinet**

- Remove the exterior and interior packing.
- Before connecting the Wine cabinet to the power source, let it stand upright for approximately 12 hours. This will reduce the possibility of a malfunction in the cooling system from handling during transportation.
- Clean the interior surface with lukewarm water using a soft cloth.
- When disposing of your appliance, please choose an authorised disposal site.

### ➤ **Installation of Your Wine cabinet**

- Place your Wine cabinet on a floor that is strong enough to support it when it is fully loaded. To level your Wine cabinet, adjust the front levelling leg at the bottom of the Wine cabinet.
- Locate the Wine cabinet away from direct sunlight and sources of heat (stove, heater, radiator, etc.). Direct sunlight may affect the acrylic coating and heat sources may increase electrical consumption. Extreme cold ambient temperatures may also cause the unit not to perform properly.
- Avoid locating the unit in moist areas.
- Plug the Wine cabinet into an exclusive, properly installed-grounded wall outlet. Do not under any circumstances cut or remove the third (ground) prong from the power cord. Any questions concerning power and/or grounding should be directed toward a certified electrician or an authorised Products service centre.

### ➤ **Attention**

- Store wine in sealed bottles;
- Do not overload the cabinet;
- Do not open the door unless necessary;
- Do not cover shelves with aluminium foil or any other shelf material which may prevent air circulation;
- Should the Wine cabinet be stored without use for long periods it is suggested, after a careful cleaning, to leave the door ajar to allow air to circulate inside the cabinet in order to avoid possible formations of condensation, mould or odours.

## OPERATING YOUR WINE CABINET AND SETTING THE TEMPERATURE CONTROL

Please use the cabinet under 5-32 °C ambient temperature, if the ambient temperature is higher than or lower than this temperature, it will cause the temperature to fluctuate in the cabinet, it may not be able to reach 5-18 °C.

### ➤ Control System Instruction

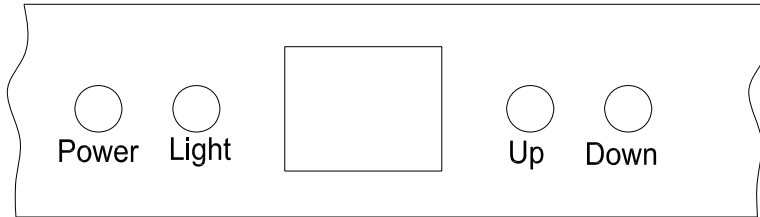

- **“Light” Button**  
To control the interior light, on/off.
- **“Power” Button**  
To control this unit power, on/off. (Press and hold this button for approximately 3 seconds);
- **“Up” Button**  
To raise (warm) the temperature in 1 °C stages.
- **“Down” Button**  
To lower (cool) the temperature in 1 °C stages.

### Setting The Temperature Controls

- To set the temperature, Connect the power cord to a properly grounded outlet In the event of power interruption, the previous temperature setting is automatically erased and it will default to a preset temperature setting of 12°C
- Set the desired cooling temperature by pressing the buttons adjacent to the “UP/DOWN” program. Each depression of the buttons will scroll through the available temperature setting in increments of 1 degree. The temperature selected will flash in the LED display for approximately 5 seconds, then revert back to display the setting temperature.
- The temperature setting can be adjusted from 5°C ~18°C

### ➤ Note

- If the unit is unplugged, power lost, or turned off, you must wait 3 to 5 minutes before restarting the unit. If you attempt to restart before this time delay, the Wine cabinet will not start.
- When you use the Wine cabinet for the first time or restart the Wine cabinet after having been shut off for a long time, there could be a few degrees variance between the temperature you select and the one indicated on the LED readout. This is normal and it is due to the length of the activation time. Once the Wine cabinet is running for a few hours everything will be back to normal.

➤ **How to change the door opening**

This appliance has reversible doors but is delivered with a right hinged door. The left hand hinge kit comes with the unit (in the box), should you wish to reverse the hinge on your unit.

- ① Bottom hinge (Right)
- ④ Door
- ⑦ Top hinge (Left)

- ② Screws
- ⑤ Top hinge (Right)
- ⑧ Bottom hinge (Left)

- ③ Door axis
- ⑥ Lock screws

1. Remove 2 screws ②, then pull door ④ as per arrowhead direction, You will remove the door. Please remove bottom hinge (Right) ① as well for the assembly. (Fig.A & Fig.B)

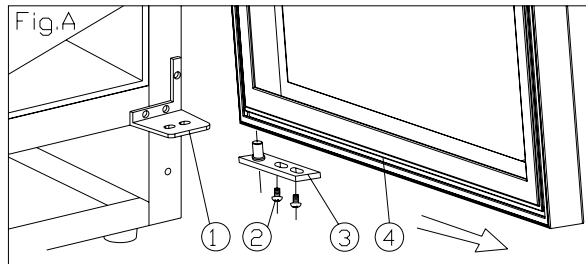

2. Remove 3 Lock screws ⑥ of Top hinge (Right) ⑤, then remove Top hinge (Right) ⑤ & Bottom hinge (Right) ①; (See fig.C)

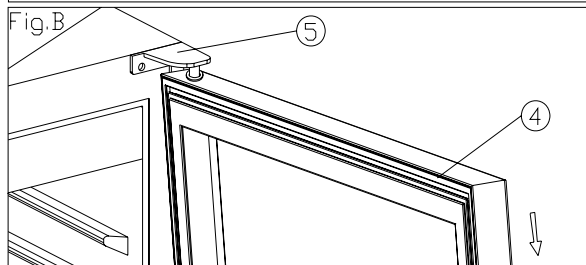

3. Use the screws which you removed From right side hinges to fix Top hinge (Left) & bottom hinges (Left) ⑦ ⑧ (See Fig.D & Fig.E)

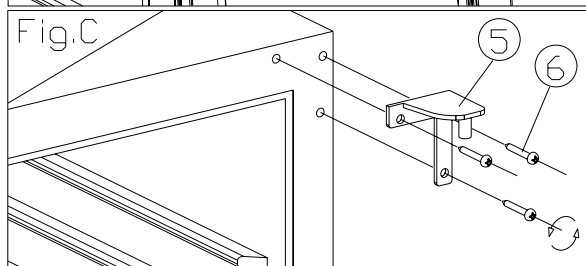

4. Rotate door at 180 degrees, then assemble the door as per the reverse way of removal.

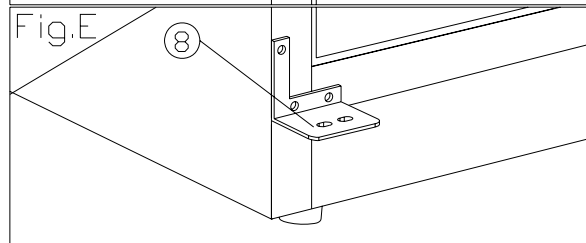
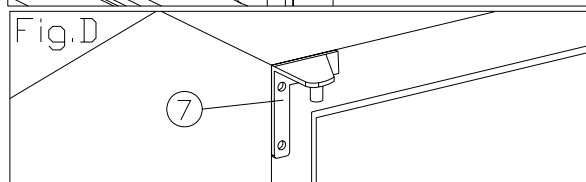

- **Install the bar handle**  
Remove the door gasket on the drilling holes side to install the handle. (see below drawing)

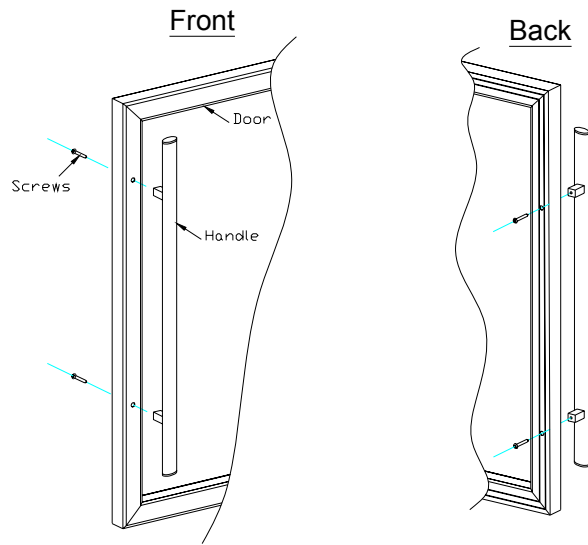

- **Installation dimensions**

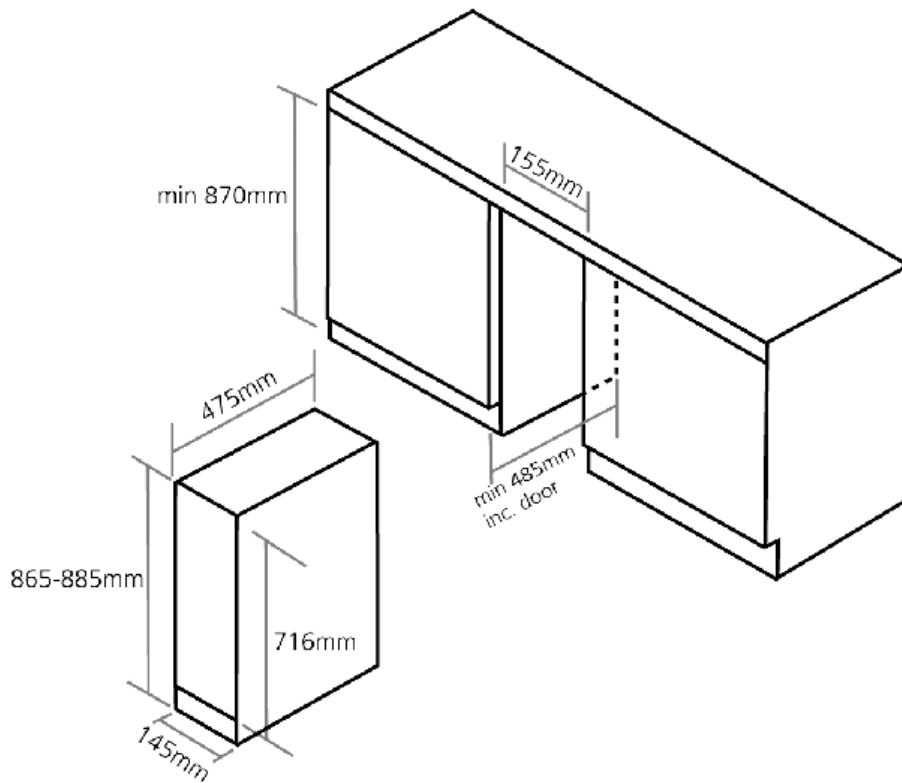

## CARE AND MAINTENANCE

### ➤ **Cleaning your wine cabinet**

- Turn off the power, unplug the appliance, and remove all items including shelves and rack.
- Wash the inside surfaces with a warm water and baking soda solution. The solution should be about 2 tablespoons of baking soda to a quart of water.
- Wash the shelves with a mild detergent solution.
- Wring excess water out of the sponge or cloth when cleaning area of the controls, or any electrical parts.
- Wash the outside cabinet with warm water and mild liquid detergent. Rinse well and wipe dry with a clean soft cloth.

### ➤ **Power failure**

- Most power failures are corrected within a few hours and should not affect the temperature of your appliance if you minimise the number of times the door is opened. If the power is going to be off for a longer period of time, you need to take the proper steps to protect your contents.

### ➤ **Vacation time**

- **Short vacations:** Leave the Wine cabinet operating during vacations of less than three weeks.
- **Long vacations:** If the appliance will not be used for several months, remove all items and turn off the appliance. Clean and dry the interior thoroughly. To prevent odor and mold growth, leave the door open slightly: blocking it open if necessary.

### ➤ **Moving your wine cabinet**

- Remove all items.
- Securely tape down all loose items (shelves) inside your appliance.
- Turn the adjustable leg up to the base to avoid damage.
- Tape the door shut.
- Be sure the appliance stays secure in the upright position during transportation. Also protect outside of appliance with a blanket, or similar item.

### ➤ **Energy saving tips**

- The Wine cabinet should be located in the coolest area of the room, away from heat producing appliances, and out of the direct sunlight.

## PROBLEMS WITH YOUR WINE CABINET?

You can solve many common Wine cabinet problems easily, saving you the cost of a possible service call. Try the suggestions below to see if you can solve the problem before calling the servicer.

### TROUBLESHOOTING GUIDE

PROBLEM	POSSIBLE CAUSE
Wine cabinet does not operate.	Not plugged in. The appliance is turned off. The circuit breaker tripped or a blown fuse.
Wine cabinet is not cold enough.	Check the temperature control setting. External environment may require a higher setting. The door is opened too often. The door is not closed completely. The door gasket does not seal properly.
Turns on and off frequently.	The room temperature is hotter than normal. A large amount of contents has been added to the Wine cabinet. The door is opened too often. The door is not closed completely. The temperature control is not set correctly. The door gasket does not seal properly.
The light does not work.	Not plugged in. The circuit breaker tripped or a blown fuse. The bulb has burned out. The light button is "OFF".
Vibrations.	Check to assure that the Wine cabinet is level.
The Wine cabinet seems to make too much noise.	The rattling noise may come from the flow of the refrigerant, which is normal. As each cycle ends, you may hear gurgling sounds caused by the flow of refrigerant in your Wine cabinet. Contraction and expansion of the inside walls may cause popping and crackling noises. The Wine cabinet is not level.
The door will not close properly.	The Wine cabinet is not level. The door was reversed and not properly installed. The gasket is dirty. The shelves are out of position.

### **DEFROSTING/CONDENSATION**

Your wine cellar is designed with an "Auto-cycle" defrost system. When the RUN cycle is OFF, the refrigerated surface of the wine cellar (interior rear wall) defrosts automatically. The defrost water is channeled into a drain pan which is located at the back of the wine cellar next to the compressor from where it evaporates.

### **HUMIDITY MAINTENANCE SYSTEM**

The wine cellar is equipped with a system for maintaining the correct level of humidity. If humidity is too low, insert the small plastic reservoir on to the top shelf. Fill this reservoir 3/4 full with water. Check the water level occasionally and refill as necessary.

### **RECOMMENDED TEMPERATURE SETTINGS**

For storing ALL TYPES OF WINES 12 °c to 14 °c

### **RECOMMENDED DRINKING TEMPERATURE**

Champagne NV, Sparkling	6 °c
Champagne Vintage	10 °c
Dry White Semillon, Sauvignon Blanc	8 °c
Dry White Gewürztraminer, Riesling	10 °c
Dry White Chardonnay	10 °c
Vintage Chardonnay	14 °c
Sweet White Sauternes Monbazillac, Late Harvest ice wine	10 °c
Sweet whites vintage Sauternes	14 °c
Beaujolais	13 °c
Red Pinot Noir	16 °c
Vintage Pinot Noir red	18 °c
Red Cabernet, Merlot, French, Australian, New Zealand, Chilean, Argentinean, Italian, Spanish, Californian	18 °c
Red Grenache, Syrah	16 °c