



Instruction manual for Wine Cabinet

Wi151 Slot-in



Contact Caple on 0844 800 3830 or for spares www.caple.co.uk

Thank you for buying your new CAPLE Wine Cabinet. To ensure that you get the best results from your new purchase, we strongly suggest that you read this instruction manual thoroughly before use. This manual contains installation advice, usage instructions and other important facts about your CAPLE Wine Cabinet. If treated with care, your CAPLE Wine Cabinet should give you many years of trouble-free use.

IMPORTANT WARNINGS AND ADVICE

- Unpack your wine cabinet carefully and remove all of the protective packing from inside and outside.
- Packing (plastic bags, polystyrene, nails, metal, etc.) must not be left within the reach of children as they are a potential source of danger.
- After unpacking, make sure that the appliance is in perfect order. If you have any doubt, do not use it and contact your retailer.
- Check that all the fittings are in the correct position on the inside of the cabinet.
- Release the mains lead which is fitted with a 13 amp UK type plug.
- Move your wine cabinet to its final location.
- DO NOT MOVE YOUR CABINET WHILE LOADED WITH WINE AS THIS COULD DISTORT THE CABINET.
- Ensure that the specified ventilation instructions are adhered to.
- Do not try to modify the appliance's technical characteristics as this could be dangerous.
- This appliance should only be used for the specific purpose for which it was designed, i.e. storage of wine. It is not designed for food storage.
- Do not clean or maintain the appliance without disconnecting it first.
- To prevent damaging the door gasket, make sure that the door is fully open when pulling shelves out.
- Ensure that you fully understand these instructions before operating this appliance.
- Caple are NOT responsible for: -
 1. Damage caused by incorrect, mistaken or irrational use.
 2. Any errors in this manual, or for any damage linked to or following the provision, performance or use of any wine cabinet.
- The information in this document is subject to modification without prior notice.

DISPOSAL OF OLD APPLIANCE

Discarded appliances are potentially dangerous to CHILDREN.

Before you throw away your old Wine Cabinet:

- Remove the door. Leave the shelves in place so that children cannot easily climb inside.
- Never allow children to operate, play with, or climb inside the appliance.

INSTALLATION INSTRUCTIONS

BEFORE TURNING THE WINE CABINET ON ENSURE IT IS PERFECTLY LEVEL. This will minimise any vibrations.

Your cabinet is equipped with 4 adjustable feet. However, we recommend that you tighten the back feet to the maximum and then use the front feet to level the cabinet.

IMPORTANT: STAND THE WINE CABINET VERTICALLY AND WAIT 12 HOURS BEFORE SWITCHING IT ON FOR THE FIRST TIME.

Safety Instructions

- A fan evacuates heat via the bottom vents.
- It must be installed well away from any heat source.
- It must not be placed in direct sun light.
- It must not be in a damp location (laundry, pantry, bathroom, etc)
- It must be perfectly level.
- It must have a correctly installed and reliable electricity supply correctly earthed.
- Use of a multi-socket or extension lead is not recommended.
- This wine cabinet must be earthed to provide protection in the event of an electrical short circuit.
- It is fitted with a power cord having an earth wire terminating in a 13amp plug.
- Consult a qualified electrician or service engineer if the earthing instructions are not completely understood.

WARNING: INCORRECT EARTHING CAN RESULT IN THE RISK OF ELECTRIC SHOCK.

OPERATING INSTRUCTIONS

The wine cabinet should be placed where the ambient temperature is between 5-35 deg centigrade (41-95 degrees Fahrenheit). If the ambient temperature is above or below this range, the performance of the unit may be affected. For example, placing your unit in extreme cold or hot conditions may cause interior temperatures to fluctuate and the range of 5-18 °C (41-65 degrees Fahrenheit) may not be reached.

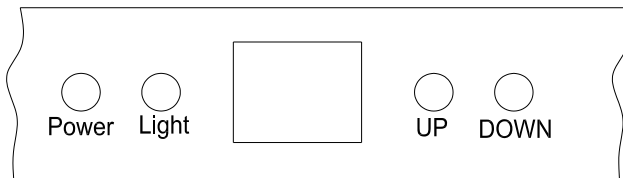

- **RUN**
Indicator light illuminates to signify the cooling cycle is currently in operation.
- **"LIGHT" Button**
To control the interior light, on/off.
- **"LIGHT"**
To control the interior light, on/off.
- **"Power"**
To control this unit power, on/off. (Press and hold this button for approximately 3 seconds);
- **"UP" Button**
To raise (warm) the temperature in 1 °C stages.
- **"DOWN" Button**
To lower (cool) the temperature in 1 °C stages.

Setting the Temperature Control

- You can set the temperature as you desire by pressing the UP or DOWN buttons. When you press either of the two buttons for the first time, the LED readout will show the original temperature set at previous time
For Wi151: The temperature preset at the factory is 12 °C.
- The temperature that you desire to set will increase by 1°C if you press the UP button once, and will decrease 1°C if you press the DOWN button once.
- The temperature selected will flash in the LED display for approximately 5 seconds, and will then display the actual temperature (which will gradually reach the set temperature).
- To view the "set" temperature, press the UP or DOWN button, then the LED display will "flash" for 5 seconds to show the "set" temperature.

NOTE:

To temporarily disconnect (stop) the cooling cycle, you must disconnect the power cord from the electrical outlet. NOTE: There is no "OFF" position on the electronic control panel. When disengaging cooling operation for long periods of time, leave the door partially open to prevent mould/mildew from forming inside the cabinet.

NOTE:

Always wait 4 minutes before restarting the unit if operation has been interrupted.

Installation of Shelves

To fit or remove the shelf, tilt the shelf as per the diagram and simply pull out, or push the shelf in until it sits on the support brackets securely.

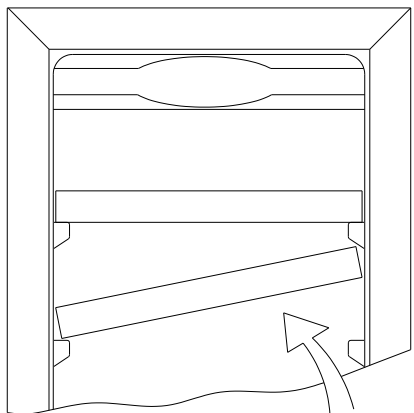

Note: The shelves for Wi151 are fitted. Please do not pull out the shelves, when removing bottles

DOOR REVERSAL

WE RECOMMEND THAT SOMEONE ASSISTS YOU DURING THIS PROCESS. TOOLS REQUIRED: PHILIPS SCREWDRIVER. (A BOTTOM LEFT HAND HINGE IS SUPPLIED WITH EACH CABINET.)

Fig.A

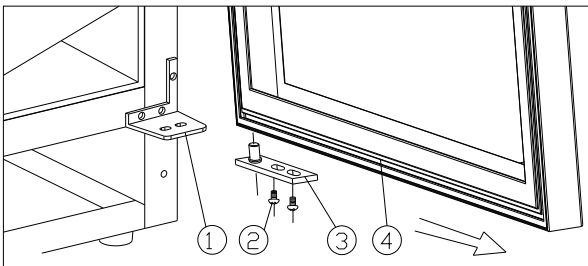

Fig.B

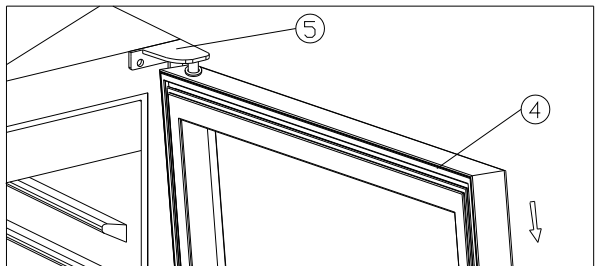

Fig.C

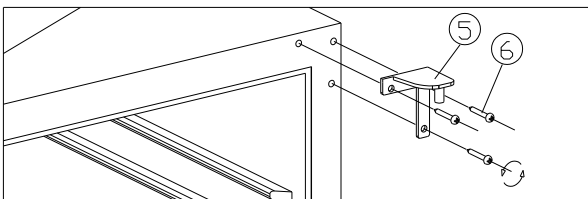

Fig.D

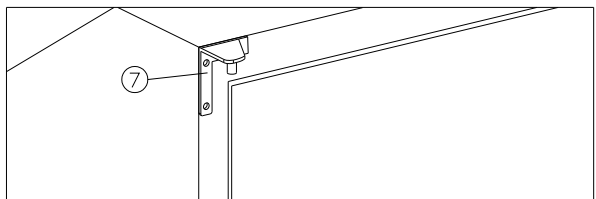
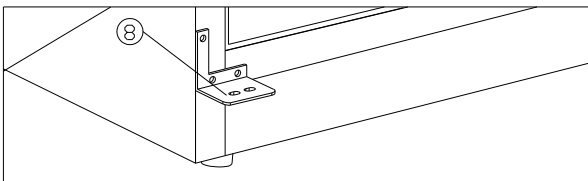

Fig.E



- Bottom hinge (Right)
- Door
- Top hinge (Left)
- Screws
- Top hinge (Right)
- Bottom hinge (Left)
- Door axis
- Lock screws

- Remove 2 screws •, then pull door • as per arrowhead direction and you will remove the door. Please remove bottom hinge (Right) • as well for the assembly. (Fig.A & Fig.B)
- Remove 3 screws• of right upper Hinge, then remove right upper• & Right lower hinges• ; (See fig.C)
- Use the screws which you removed From right side hinges to fix left upper & bottom hinges• • (See Fig.D & Fig.E)
- Rotate door at 180 degrees then assemble the door as per the reverse way of removal

Install the bar handle

Remove the door gasket on the drilling holes side to install the handle. (see below drawing)

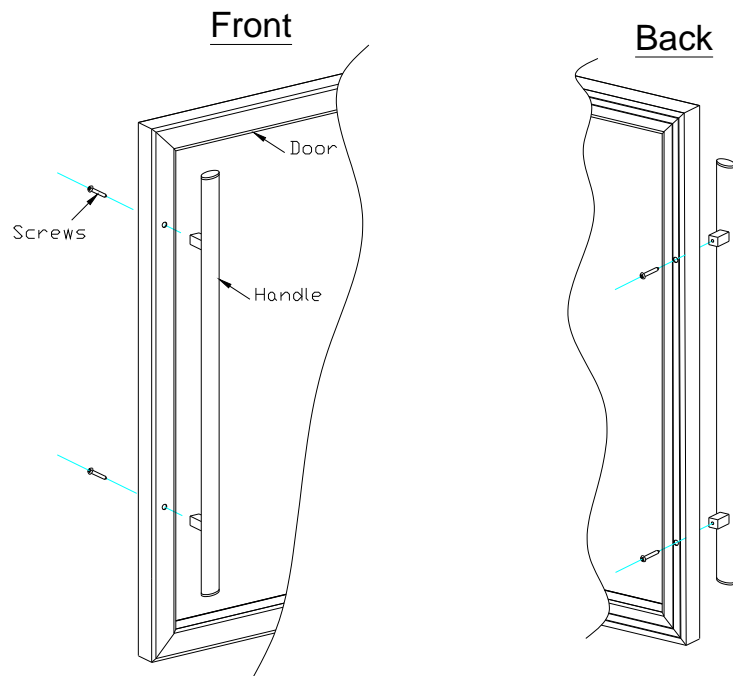

DEFROSTING/CONDENSATION

Your wine cabinet is designed with an "Auto-cycle" defrost system. When the RUN cycle is OFF, the refrigerated surface of the wine cabinet (interior rear wall) defrosts automatically. The defrost water is channeled into a drain pan which is located at the back of the wine cabinet next to the compressor from where it evaporates.

HUMIDITY MAINTENANCE SYSTEM

The wine cabinet is equipped with a system for maintaining the correct level of humidity. If humidity is too low, insert the small plastic reservoir on to the top shelf. Fill this reservoir 3/4 full with water. Check the water level occasionally and refill as necessary.

CARE AND MAINTENANCE

Cleaning

- Turn off the power, unplug the appliance, and remove all items including shelves and rack.
- Wash the inside surfaces with a warm water and baking soda solution. The solution should be about two tablespoons of baking soda to one litre of water.
- Wash the shelves with a mild detergent solution.
- Wring excess water out of the sponge or cloth when cleaning the control panel, or any electrical parts.
- Wash the outside cabinet with warm water and mild liquid detergent. Rinse well and wipe dry with a clean soft cloth.

Power Failure

- Most power failures are corrected within a few hours and should not affect the temperature of your appliance if you minimise the number of times the door is opened. If the power is going to be off for a longer period of time, you need to take action to protect the contents.

Vacation Time

- Short vacations: Leave the wine cabinet operating during vacations of less than three weeks.
- Long vacations: If the wine cabinet will not be used for several months, remove all items and disconnect. Clean and dry the interior thoroughly. To prevent odour and mould growth, leave the door open slightly (blocking it open if necessary).

Moving Your Wine Cabinet

- Remove all bottles.
- Securely tape down all shelves inside the cabinet.
- Turn the adjustable legs up to the base to avoid damage.
- Tape the door shut.
- Be sure the appliance stays secure and upright during transportation. Also protect the outside of the wine cabinet. (e.g. with a blanket).

Energy Saving Tips

- The wine cabinet should be located in the coolest area of a room, away from heat producing appliances, and out of the direct sunlight.

TROUBLE SHOOTING GUIDE

You can solve many common wine cabinet problems easily, saving you the cost of a possible service call. Try the suggestions below to see if you can solve the problem before calling the service engineer.

PROBLEM	POSSIBLE CAUSE
The wine cabinet does not operate.	The appliance is not plugged in. The appliance is turned off. The circuit breaker has tripped or a fuse has blown.
The wine cabinet is not cold enough.	Check the temperature control setting. The external environment may require a higher setting. The door has been opened too often. The door is not closed completely. The door gasket does not seal properly.
The wine cabinet turns on and off frequently.	The room temperature is hotter than normal. A large amount of bottles have been added to the wine cabinet. The door has been opened too often. The door is not closed completely. The temperature control is not set correctly. The door gasket does not seal properly.
The light does not work.	The appliance is not plugged in. The circuit breaker has tripped or a fuse has blown. The bulb needs replacing. The light button is "OFF".
The wine cabinet vibrates.	Check that the wine cabinet is level.
The wine cabinet seems to make too much noise.	The rattling noise may come from the flow of refrigerant, which is normal. As each cycle ends, you may hear gurgling sounds caused by the flow of refrigerant. Contraction and expansion of the inside walls may cause popping and crackling noises. The wine cabinet is not level.
The door will not close properly.	The wine cabinet is not level. The door was reversed and not properly installed. The gasket is dirty. The shelves are out of position.

RECOMMENDED TEMPERATURE SETTINGS

For keeping ALL TYPES OF WINES

12 °c to 14 °c

Dry White Semillon, Sauvignon Blanc

8 °c

Dry White Gewurstraminer, Riesling

10 °c

Dry White Chardonnay

10 °c

Vintage chardonnay

14 °c

Sweet White Sauternes Monbazillac, Late Harvest ice wine

10 °c

Sweet whites vintage Sauternes

14 °c

Beaujolais

13 °c

Red Pinot Noir

16 °c

Vintage Pinot Noir red

18 °c

Red Cabernet, Merlot, French, Australian, New Zealand, Chilean,
Argentinean, Italian, Spanish, Californian

18 °c

Red Grenache, Syrah

16 °c