



WC6217

Caple 60cm Wine Cabinet



Technical information



WC6217

Caple 60cm Wine Cabinet

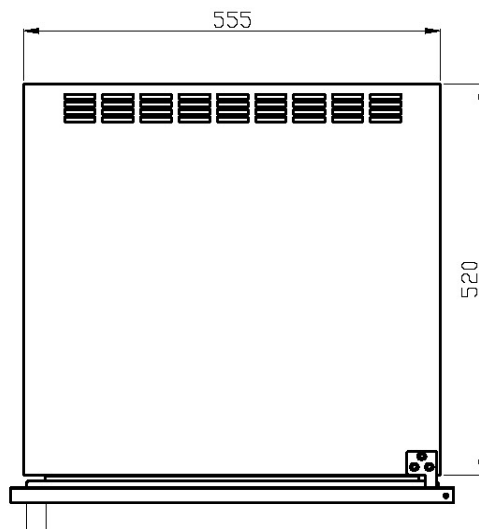
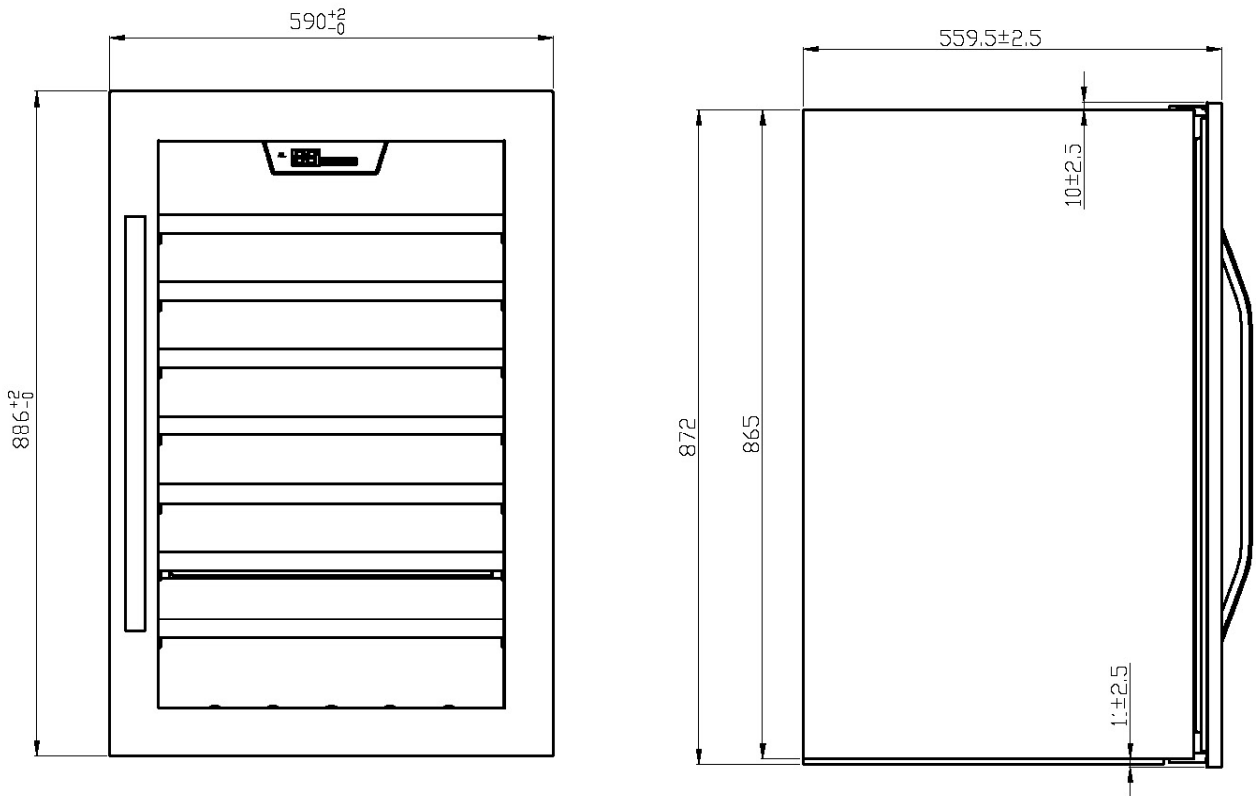

Top View



WC6217

Caple 60cm in-column wine cabinet

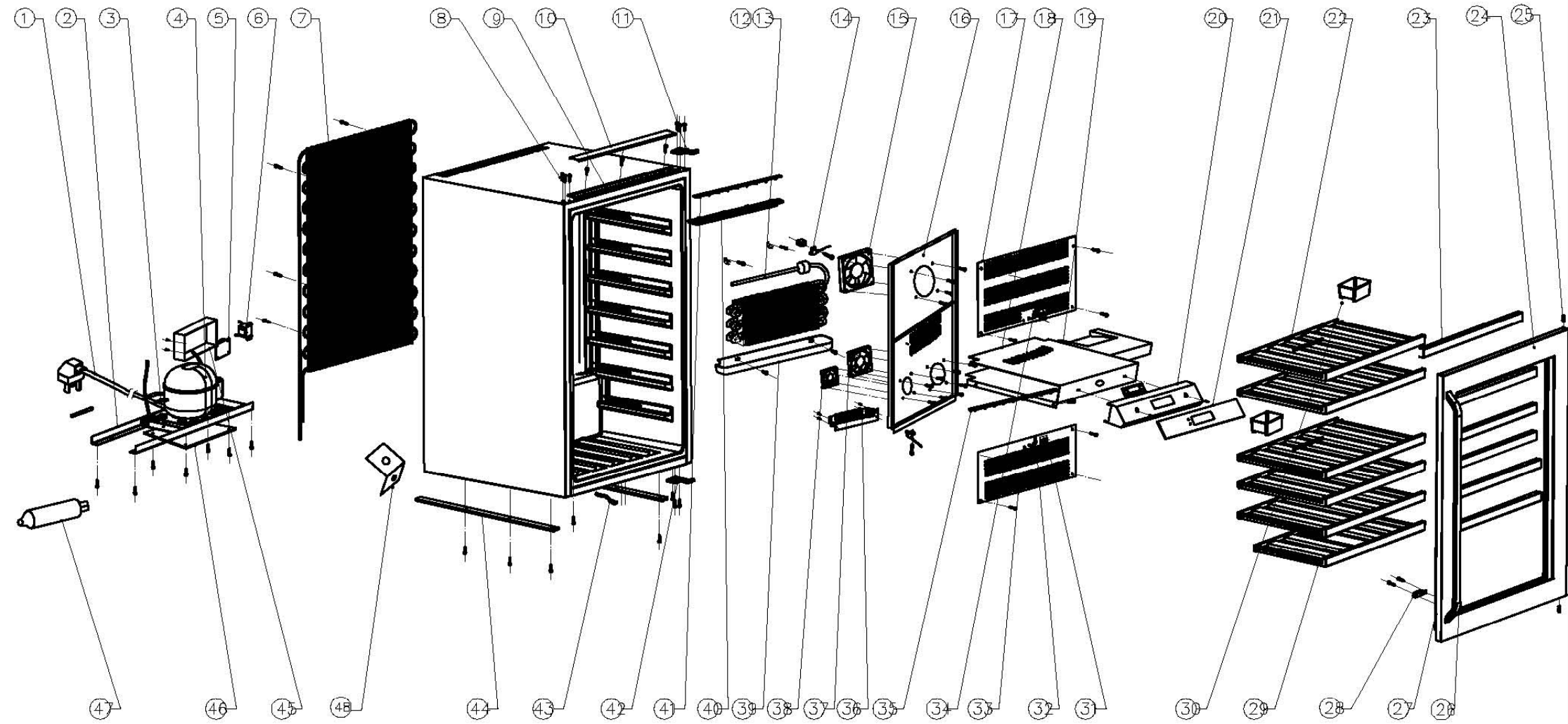



WC6217 - Caple 60cm in-column Wine Cabinet

Item	Part Code	Description	Qty
1	DG2-14	Power cord	1
2	DG22-476	Support bar of tank water	2
3	DG13-447	Water box	1
4a	DG1-93	Compressor	1
4b	PJ1-002-C	Start Device / Overload Protector	1
5	DG3-206	PCB board	1
6	DG6-18	Transformer	1
7	DG11-41	Condenser	1
8	DG13-268	Decorative nail	3
9	DG13-473	Limiting bar(B)	1
10	DG13-472	Limiting bar(A)	1
11	DG14-177	Top hinge module	1
12	DG121A	Evaporator	1
13	DG12-6.1	Air-circulating pipe	1
14a	DG20-1	Wire clamp	1
14b	DG8-8	Senser	1
15	DG7-48	Evaporator fan	1
16	DG22-498	Air duct board	1
17	DG22-499	Upper panel for air-leaded board	1
18	DG22-3000	Middle airway-board	1
19	DG18-98	Foam	1
20	DG13-469	Display support	1
21	DG20-261	Display panel	1
22a	DG15-179	Wooden shelves	3
22b	DG15-179-1	Wooden shelves	2
23	DG15-193	Decorative bar of stainless steel	6
24	DG23-176-3	Door	1
25	DG22-475	Axis	2
26	DG22-3064	Handle	1
27	M147-005	Gasket	1
28	DG13-3005	Magnet	1
29	DG15-178	Wooden shelves	1
30	DG13-1.2	Humid box	2
31	DG13-198	Senser cover	2
32	DG8-8	Senser	1
33	DG22-500	lower panel for air-leaded board	1
34	DG8-8	Senser	1
35	DG3-18-W	LED Light	1
36	DG11-18	PTC heater	1
37	DG7-33-BH	Fan	1
38	DG7-41-BH	PTC heater fan	1
39	DG13-458	Tank water of airway-board	1
40	DG13-129	LED light cover	1
41	DG3-14-W	LED light	1



WC6217 - Caple 60cm in-column Wine Cabinet

Item	Part Code	Description	Qty
42	DG14-176	Lower hinge module	1
43	DG9-16	Reed switch	1
44	DG13-474	Support bar	2
45	DG22-3005	Electrical box cover	1
46	DG22-473	strengthening board	1
47	DG11-45	Drier	1
48	DG14-3.1-1	Fixed capacitor	1



WC6217

Caple 60cm Wine Cabinet

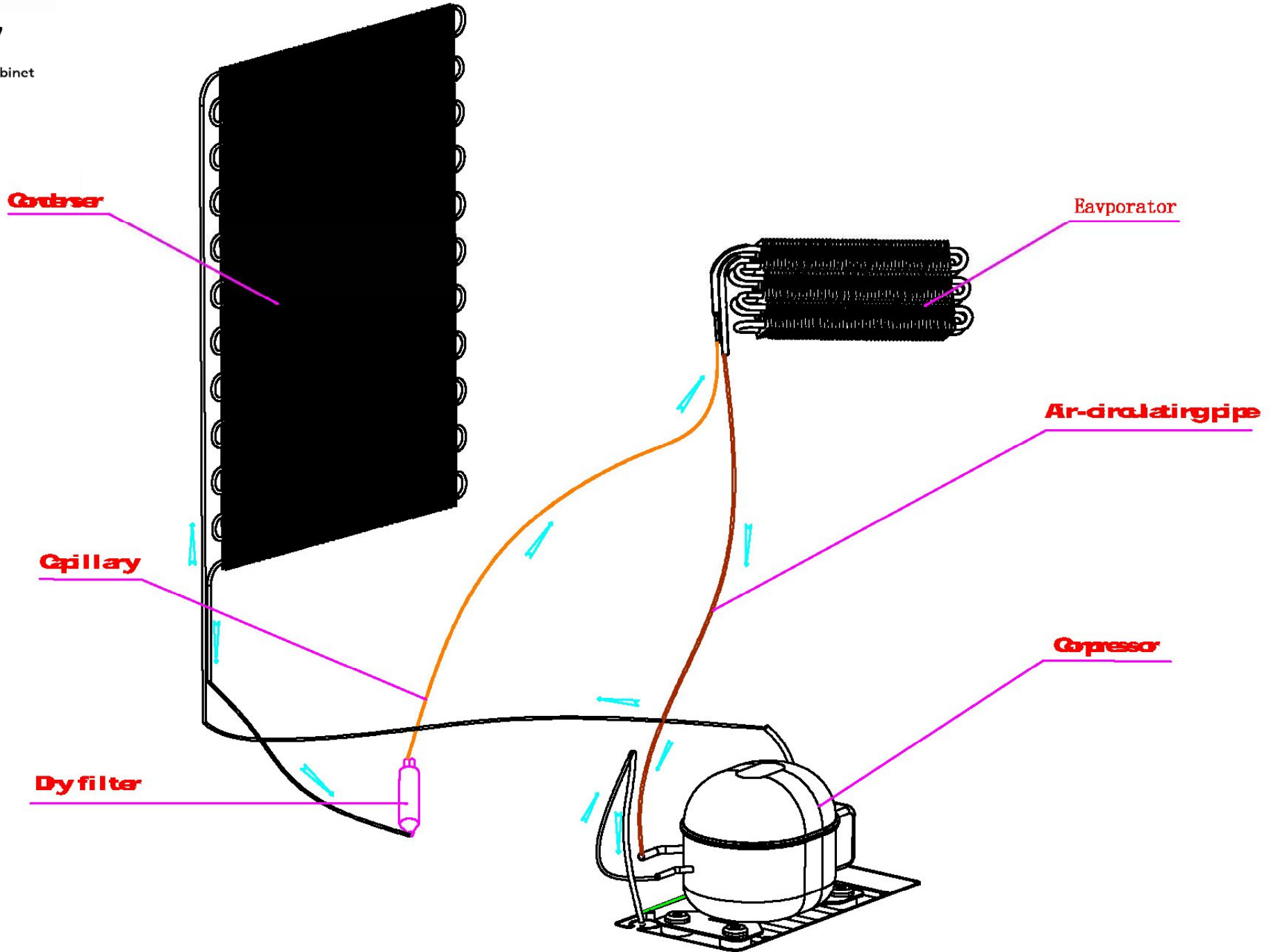

Computer Controlled Wine Cellar

JG48B

Service Manual

Here below we listed various faults while using the wine cellar, and the method of check-up and solve these default, and find the information of the correspondent page.

Statement: (Fig.4) shows the reference figure Fig4
(→6) shows the reference page 6

Warning: before attempting any cleaning or maintenance this unit MUST be disconnected from the electrical supply, to prevent electrical shock

▲Preparation before maintenance

○ Tools

- | | |
|--|-------------------------------|
| 1. Pliers | 2. Phillips head screwdrivers |
| 3. Process pipe | 4. Electrical Multi meter |
| 5. Amp meter (5A) (caliper cable type) | 6. Electrical soldering iron |
| 7. Wire strippers | 8. Seal pliers |

○Equipment

- | | | |
|----------------|------------------------------------|----------------------|
| 1. Vacuum pump | 2. Soldering iron for copper pipes | 3. Refrigerant meter |
|----------------|------------------------------------|----------------------|
-

- | | |
|--|----|
| 1. Safety rules on operation of repairing. (Rules must be obeyed). | 2 |
| 2. Electrical circuit diagram. | 4 |
| 3. Cooling system diagram. | 5 |
| 4. Name and function on control panel. | 5 |
| 5. How to diagnose the fault. (E1、 E2、 E3、 E4) | 6 |
| 6. Gist on disassembly. | 9 |
| 7. How to maintain the default. | 19 |



1. Safety rules on operation of repairing (Rules must be obeyed).



To avoid the accident during maintain the wine cooler, and make sure the product is safety, rules must be obeyed list below.

○ Below we list the symbols and explain the danger if ignore it.

	Danger	This symbol means that the instance may have the chance to suffer death or a serious wound.
	Warning	This symbol means that the instance may have the chance to suffer death or a serious wound.'
	Notice	This symbol means that the instance may have the chance to suffer a wound.'

○Below symbols' distinguish and rules should be obeyed.

	This symbol means the instance hope to be noticed		This symbol means the instance must be done forcibly
 禁止	This symbol means the instance forbidden		

 Danger	
	<ul style="list-style-type: none"> • Please make sure to discharge the rest refrigerant in the parts. • When discharging refrigerant, make sure that it never go to the fire place and drain to outdoors. <p>Tell the customers that they never close to the discharge place and the fire is forbidden.</p> <ul style="list-style-type: none"> • Take apart the pipe by cutter. <p>Never take apart the part by soldering, otherwise it will fire the rest refrigerant in the systems and cause blast.</p> <ul style="list-style-type: none"> • Exhaust the rest refrigerant in the systems before welding. • After filling the refrigerant the sealing should be done by using smithing welding nozzle. <p>Using the welding machine will fire the refrigerant and blast.</p> <ul style="list-style-type: none"> • Since the R600a is heavier than the air, please let the R600a on the ground go especially for the hypogeum. • The operation on the servicing refrigerant bottle should be done in place without fire and outdoors. • Use the refrigerant warner please, as the rest refrigerant will cause the fire.
 禁止	<ul style="list-style-type: none"> • Don' t use fire in the place with rest refrigerant. • Don' t place the default compressor in indoor.



Danger



拔掉电源
插头

- During repairing, the power plug should be disconnected.
Before remove, install, replace parts disconnect the power plug.



小心触电

- Attention don' t get electric shock.
When checking current, voltage or charging never touch the connectors.
When changing the parts, don' t touch the charged parts within three minutes after disconnect the plug.
The capacitor will discharge for some time.



禁止

- Don' t damage the cooling pipe, sine the refrigerant is flammable, the damage will cause the fire or blast.
- Don' t smoking in the service car.



- Discharge the refrigerant entirely in the place without fire before disusing the refrigerant bottle.
 - Don' t touch the wine cooler when the cooling pipe damaged, don' t fie inside the wine cooler, keep the windows open to exchange the air.
 - Disusing the default compressor should be done outdoor without fire.
 - The maximum weight of the refrigerant bottle loaded in the vehicle should be comply to stated, the bottle should be place upright, the maximum leaning angle is 40° .
 - Do use the appointed part, otherwise it have chance to smoke fire or default.
 - Please put the default compressor into plastic bag and seal the peristome, then pack it with strip, as the rest compressor oil may leak in the vehicle and cause fire or blast.
 - Check if all the snails, parts, wiring are install in it' s place, if the area around the service part worsen.
- When measuring the grounding resistance make sure that the test range is more than 1M Ω .
- Make sure the power cord and plug never be pinched on rear of the wine cooler.
Exchange the power cord when it damaged.
Clean the flake of the plug when it dirty.



Notice



注意高温

- Attention the hot.
- The running or just stop compressor and the pipe sometimes are very hot. And the heating or just stop heater is very hot. The hot will cause scald.
- Attention the hot parts of the pipe after the welding.



- Attention the refrigerant during charge and discharge it, as it will frostbite the skin when touch it.
- Attention the burr.
- The burr on the metal or plastic part may hurt the hand.
- Attention the fins of the evaporator.
- The fins of the evaporator may hurt the hand.



- Drive up the wine cooler when moving it. Pushing it may damage the floor. Cover a protector board on the easy damage floor.

2. Electrical circuit diagram.

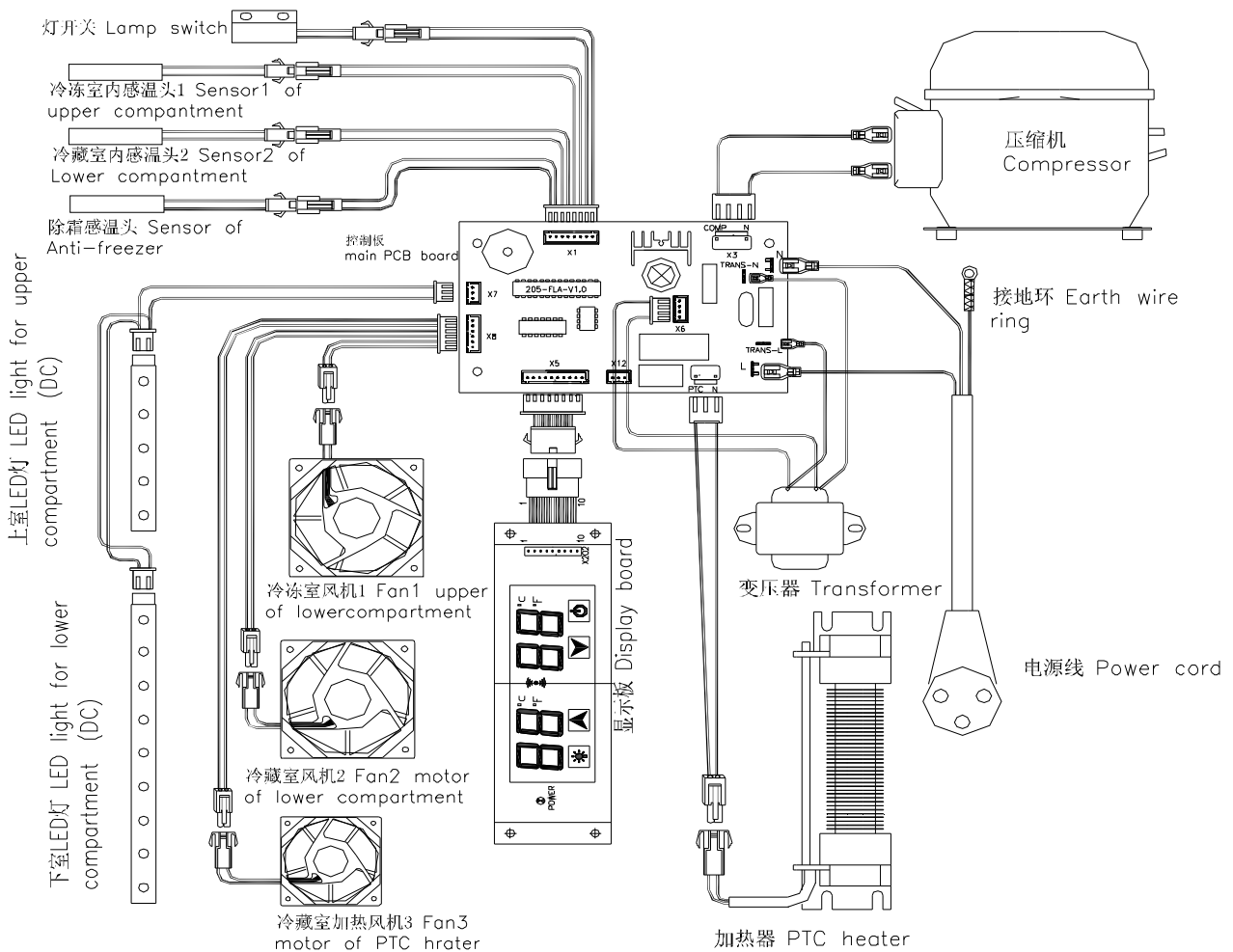

3. Cooling system diagram.

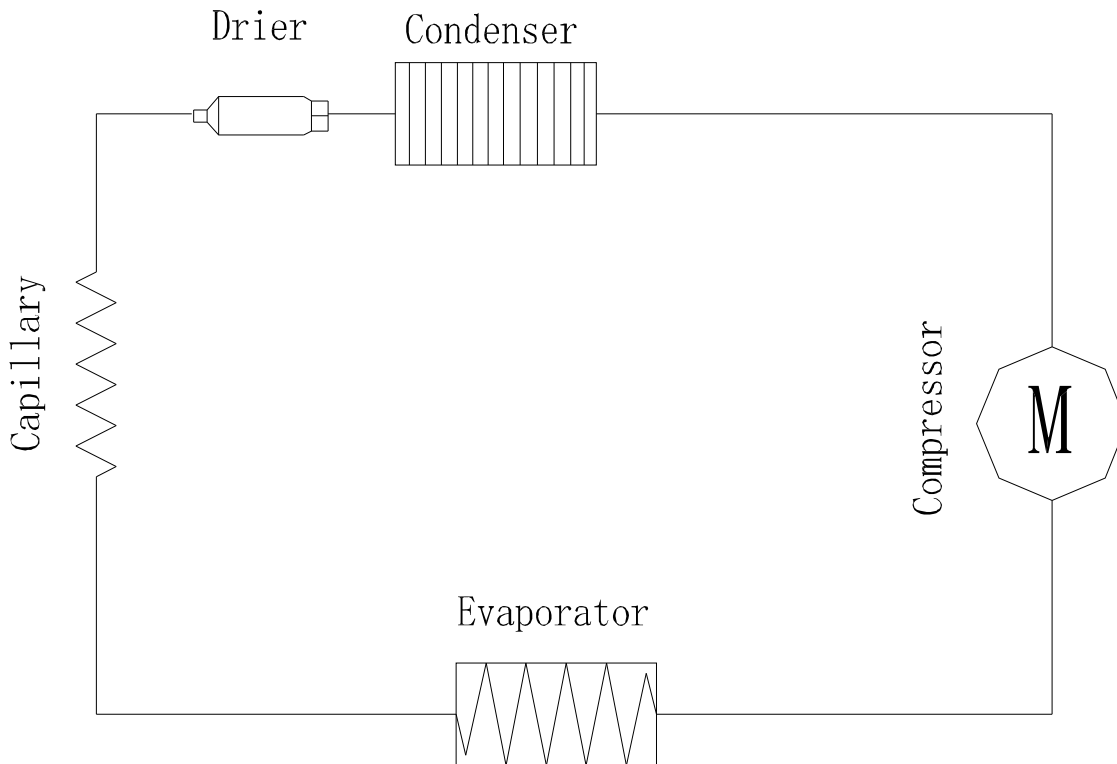

4. Name and function on control panel.

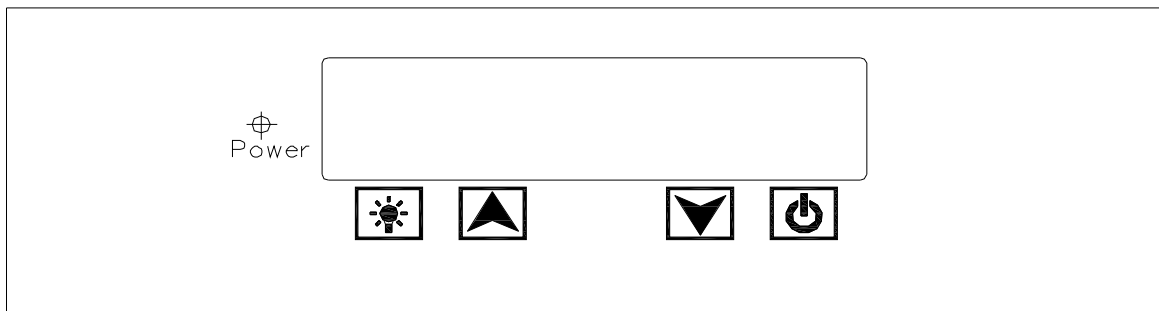

- **“POWER”** This LED light on means the power is on.
 - “▲” Use for upper compartment setting, press ‘▲’ one time, the upper compartment setting temp will lower down in 1.
 -
 - “▼” Use for lower compartment setting, press ‘▼’ one time, the lower compartment setting temp will lower down in 1.
 -
 - “💡” Press one time, the light on, press again, the light off, it is not effect by the door switch. Press it and hold on for three seconds will enter the time adjustment. Press ‘▲’ adjust the hour, press ‘▼’ adjust the minute.
 - “🔌” Press it one time, the power on, press it and hold on for three seconds, the power off.
- i The default setting temp of this wine cooler are upper compartment 6, lower compartment 12, but when restart the wine cooler after power off, it will back to the former setting temp

before power off.

- i According to customers' requirement, this wine cooler can be set to that the readout display actual temp or setting temp.
 - a. The systems enter the temperature setting mode and the setting temperature twinkling. Five seconds twinkling after stopping adjust temperature, the readout stop twinkling and the readout show actual temperature, the temperature setting mode end.
 - b. In the readout display actual temp mode, press the '▲' or '▼' , the systems enter the temperature setting mode and the setting temperature twinkling. Five seconds twinkling after stopping adjust temperature, the readout stop twinkling and the readout show actual temperature, the temperature setting mode end.

5. How to diagnose the fault.

5.1 Fault finding by the self-check mode.

The wine cooler is controlled by computer, in order to maintain the wine cooler easily, there is a self-check function in the control PCB.

If you suspect that the control system fault, you can star the self-check mode by following below:

1 >. Power on the wine cooler, it will beep one sound, the wine cooler star, within 10 seconds after it star, press the '▲' and '▼' at the same time and holding, three beep will sound, the systems enter self-check mode.

The power indication light on.

The readouts show the actual temperatures.

The "Run" light on.

The heater on and last for ten seconds

The LED light on.

The inner and outer fans running.

No response when touch the controlled button.

2>. If all tally with above description, the parts are normal. If any part failed, check the failed part and the corresponding wiring and connection, if the wiring and connection is in good condition, replace the part and check again, if it still failed, the default should be the control PCB, replace it with same model. (→ 6.2.1)

3 >. The self-check can be quit only disconnect the power plug.

5.2 Err code

Symbol	Representation	Checking point	Solution
E1	Upper compartment sensor open circuit	Check the wiring and connection between PCB and sensor, if it open circuit.	If the connection and wiring is normal, replace the sensor please.
E2	Upper compartment sensor short circuit	Check the wiring and connection between PCB and sensor, if it short circuit.	If the connection and wiring is normal, replace the sensor please.
E3	Defrost sensor open circuit	Check the wiring and connection between PCB and sensor, if it open circuit.	If the connection and wiring is normal, replace the sensor please.
E4	Defrost sensor short circuit	Check the wiring and connection between PCB and sensor, if it short circuit.	If the connection and wiring is normal, replace the sensor please.
E7	Lower compartment sensor open circuit	Check the wiring and connection between PCB and sensor, if it open circuit.	If the connection and wiring is normal, replace the sensor please.
E8	Lower compartment sensor short circuit	Check the wiring and connection between PCB and sensor, if it short circuit.	If the connection and wiring is normal, replace the sensor please.
HI	Inner temperature too high	A Check if any refrigerant leakage.	Repair the leakage and refill.
		B Check if the capillary jam	Clean or replace the capillary.
		C Check it the inner fan run normally	Repair the wiring or replace the fan.
LO	Inner temperature too low	a Check if the inner fan run normally	Repair the wiring or replace the fan.
		b Check if the PCB normal.	Replace the PCB.

“HI” High temperature warning—After turning on the wine cooler ten hours, if the inner temperature is over 23°C, the readout show HI, after it showing for one hour, the “HI” twinkling and the buzzer alarm, and twenty minutes later, the buzzer stop, the compressor stop, the readout keep twinkling. The HI alarm can be stopped by disconnect the power plug.

“LO” Low temperature warning—After turning on the wine cooler two hours, if the inner temperature is lower than 0 °C and lasting for 15 minutes, the readout show “LO”, the buzzer alarm, and the compressor stop at the same time, when the inner temperature is over 2°C, the LO warning stop.

* Remark: some models without the “HI” and “LO” warning function.

5.3 Diagnose the defaults

● There isn't any display on the display PCB.

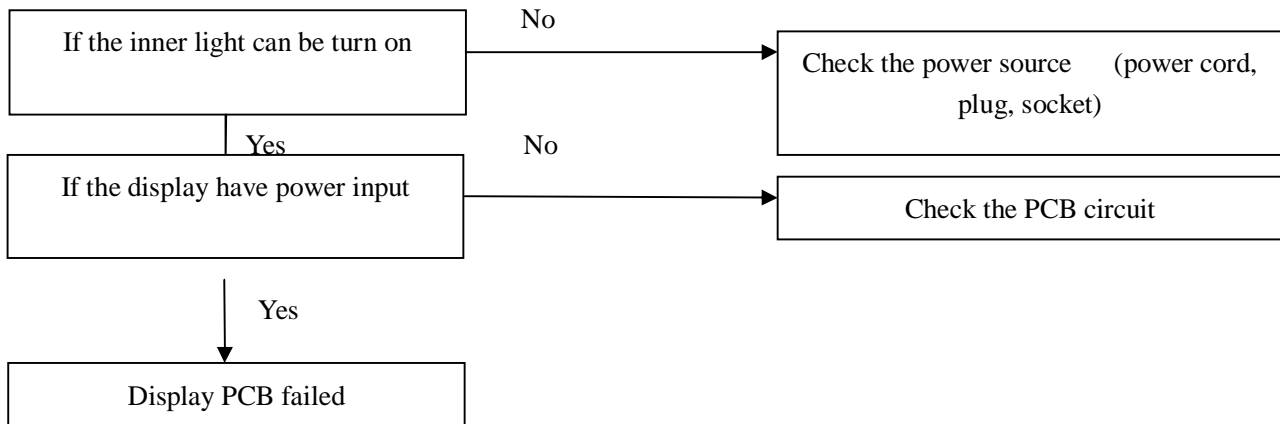

● Not cooling (the compressor stop)

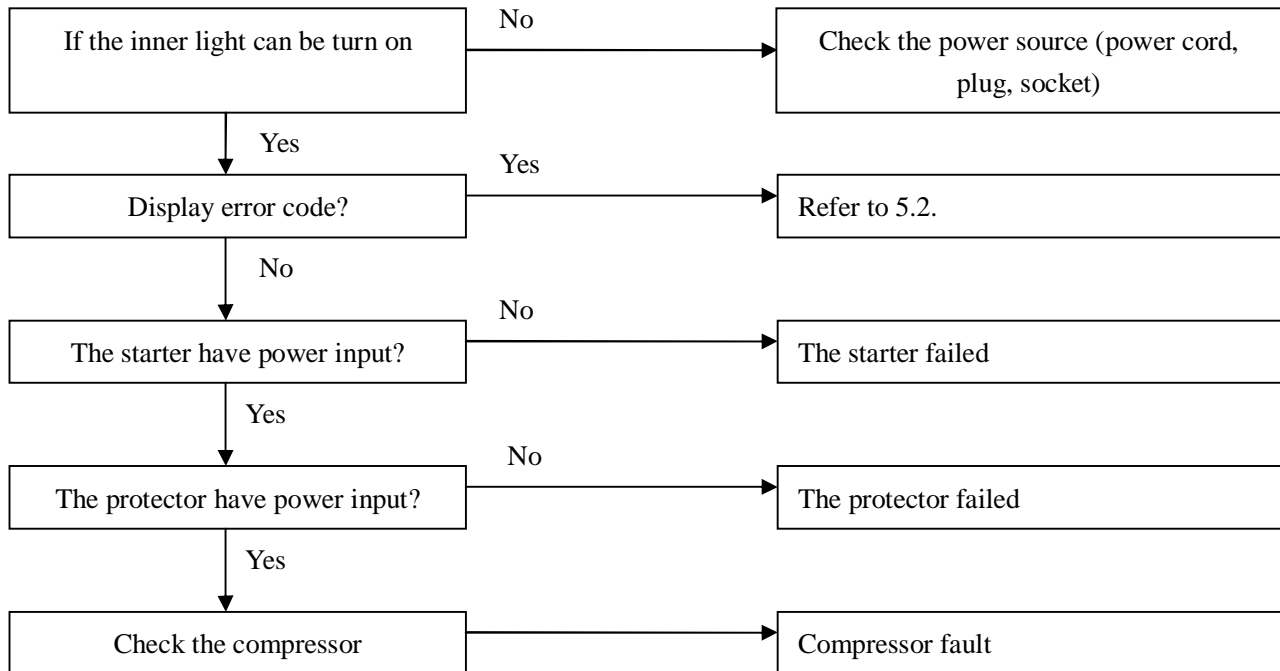

● Not cooling (the compressor running)

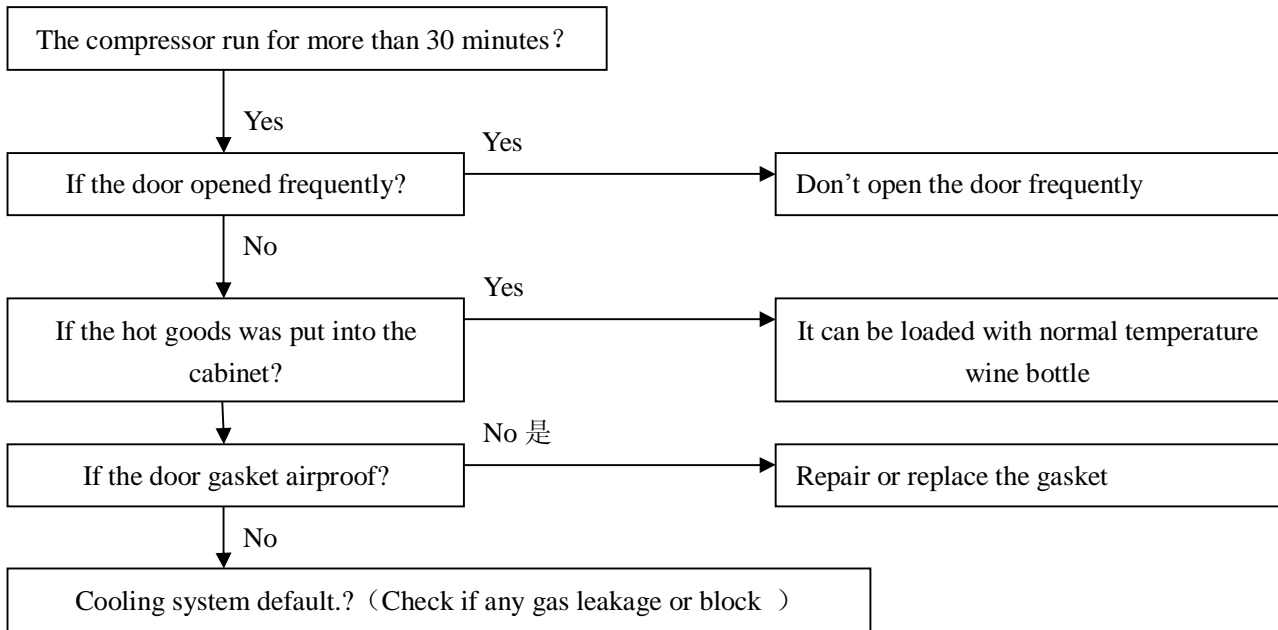

6. Gist on disassembly.

Warning: Disconnect the power plug before maintain the wine cooler.

6.1 Gist on disassembling the inner cabinet.

6.1.1. How to remove the shelves.

Push the shelf to the end, and revolve the shelf on either side, make the stopper on the out of the guiding rail, then pull the shelf out (Fig.1).



6.1.2. How to remove the air-duct board

The process of removing the air-duct board: Remove all shelves → Remove control panel film → Remove the display supporter → Remove the middle electrical box → Remove the upper

and lower air duct board → Remove the back air-duct board

1. Peel off the control panel film

The process: Remove all shelves → Remove control panel film

Remove all shelves, then peel off the control panel film. Be careful don't damage the control panel file, as it have to be fixing again. (Fig.2)



Control panel film

2. Remove the display supporter

The process: Remove the shelves → Remove the control panel film → Remove the screws → Remove the display supporter.

Remove the shelves, after removing the control panel film (Fig.2), remove the screws (A) and (B), disconnect the wiring connector, and we can remove the display supporter. (Fig.3)

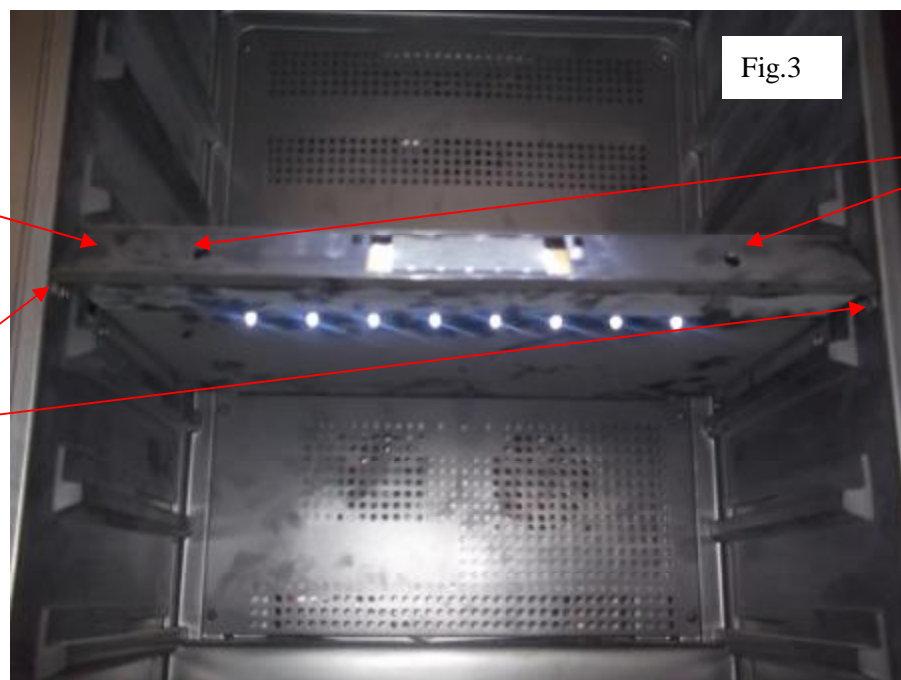

Display connector

Screws A

Screws B

3. Remove the middle electrical box

The process: Remove the shelves→Remove the control panel film→Remove the screws
→Remove the display supporter →Remove the middle electrical box

Remove the shelves, remove the control panel and display supporter (Fig.2, Fig.3), Remove the four middle electrical box fixing screws, disconnect the light connector, remove the middle electrical box. (Fig.4)

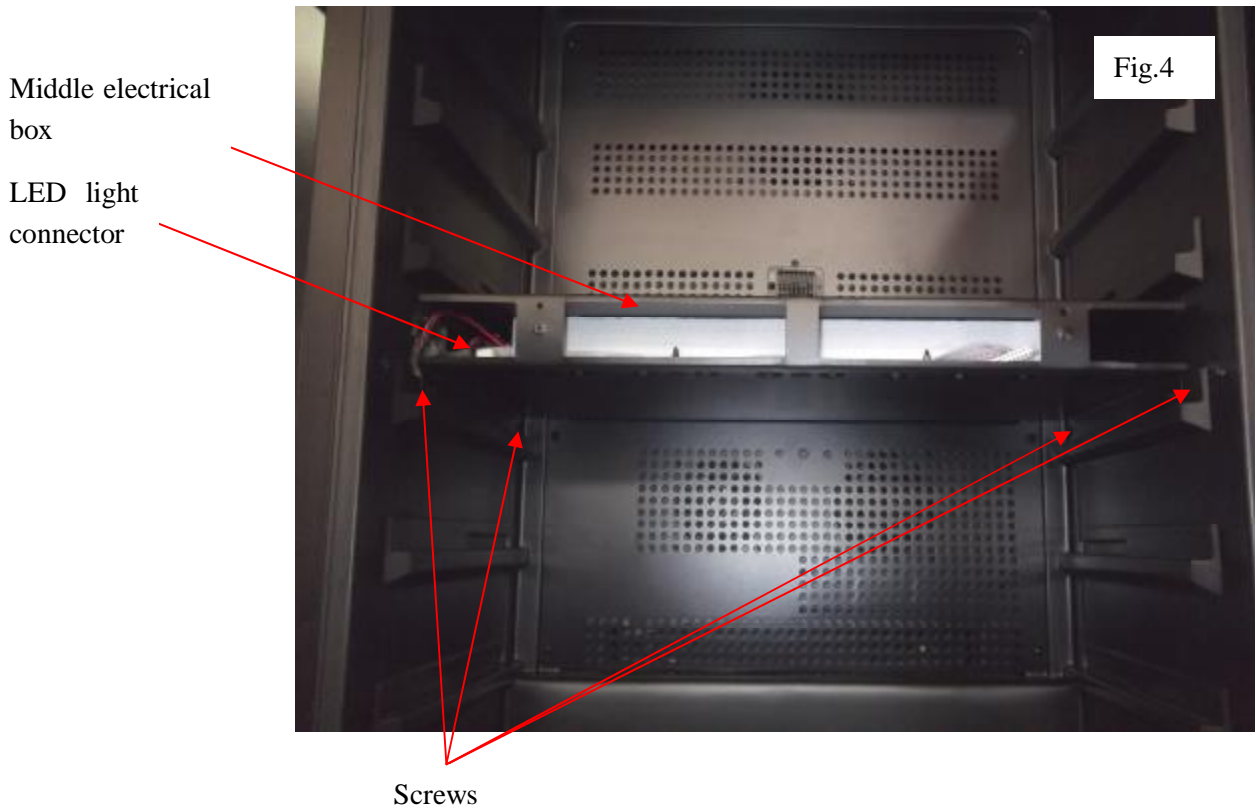

4. Remove the upper and lower air-duct board

The process: Remove the shelves→Remove the control panel film→Remove the screws
→Remove the display supporter →Remove the middle electrical box→ Remove the screws→Remove the upper and lower air-duct board.

Remove the shelves, remove the control panel and display supporter (Fig.2), Remove the four middle electrical box fixing screws, disconnect the light connector, remove the middle electrical box. (Fig.4), remove the middle air-duct board fixing screws, remove the middle air-duct board (Fig.5).

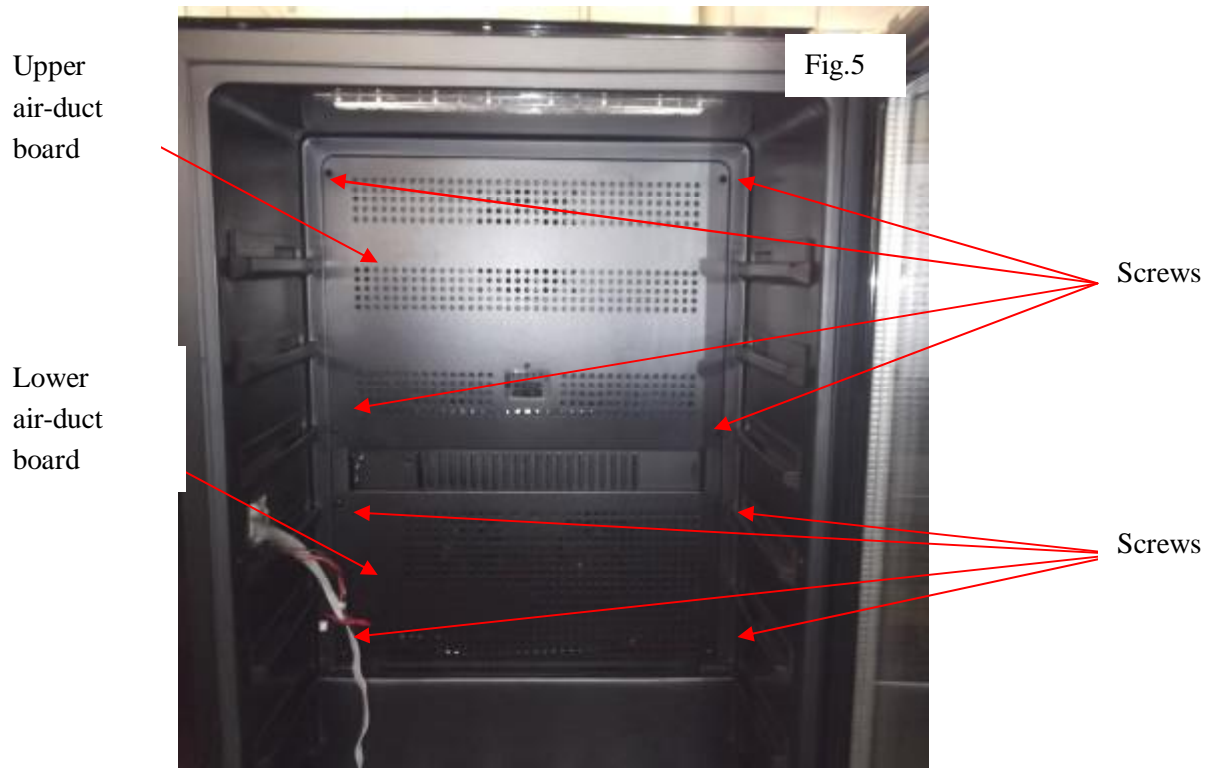

5. Remove the inner air-duct board

The process: Remove the shelves→Remove the control panel film→Remove the screws →Remove the display supporter →Remove the middle electrical box→ Remove the screws→Remove the upper and lower air-duct board. → Remove the inner air-duct board

1) .After remove the upper and lower air-duct board, remove the inner air-duct board fixing screws, and then remove the inner air-duct board.

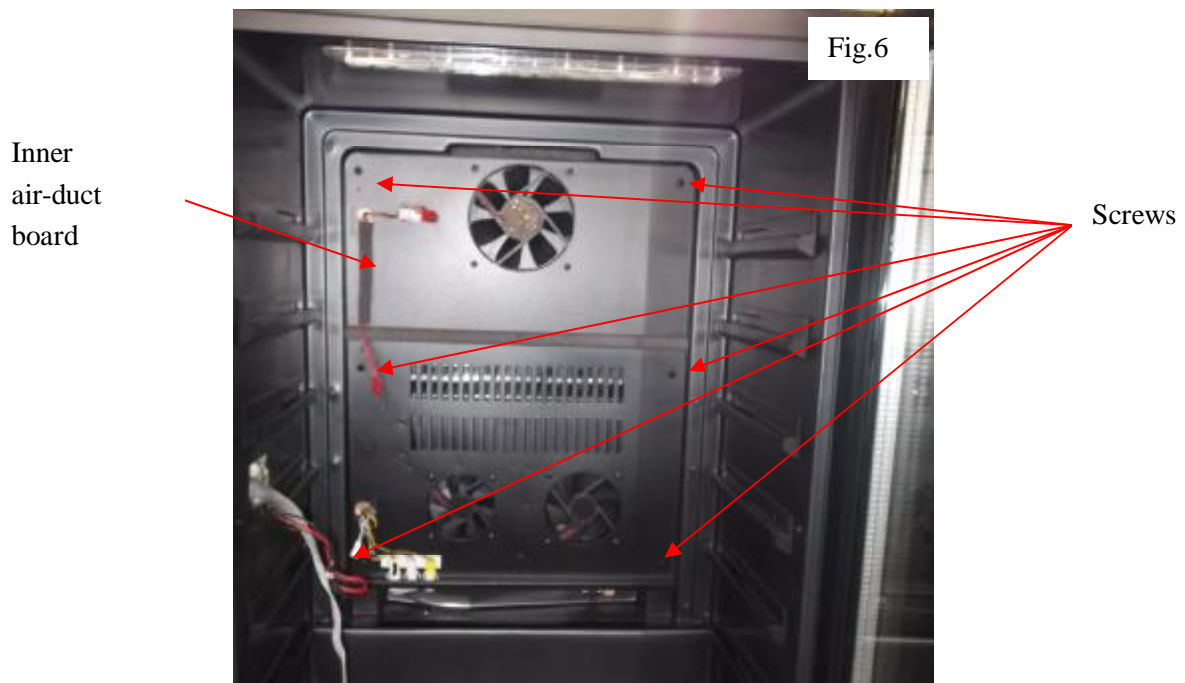

2) .After removing the inner air-duct board, we can see suction pipe and capillary pipe joint (Fig.7)

A: Capillary solder joint. B: Suction pipe solder joint C: Upper compartment fan connector
D: Upper compartment sensor connector E: Heater fan connector F: Heater connector
G: Defrost sensor connector H: Air cycling fan connector I : Lower compartment sensor
J: evaporator

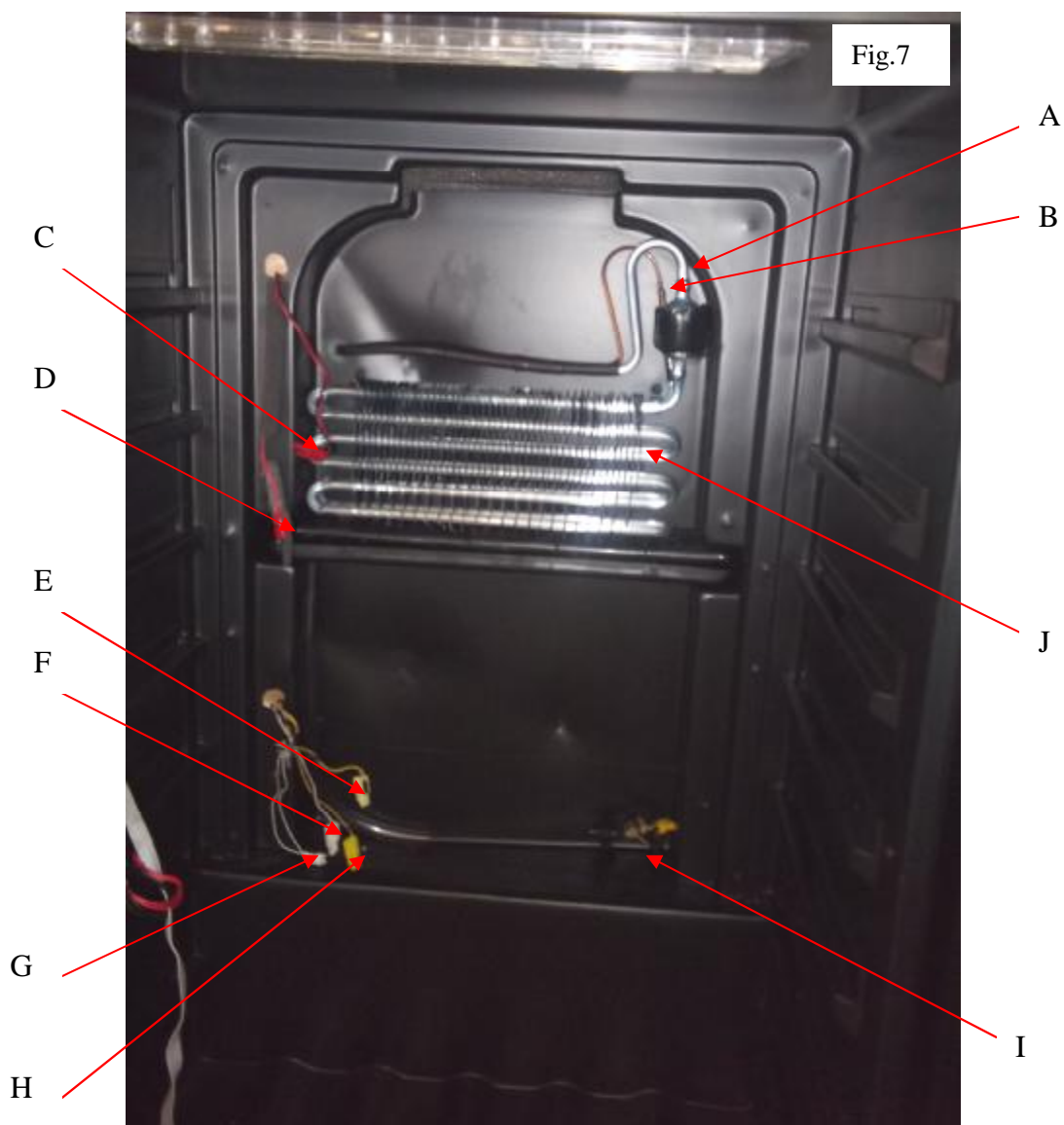

6.1.3. How to remove the evaporator

The process: Remove the shelves→Remove the control panel film→Remove the screws
→Remove the display supporter →Remove the middle electrical box→ Remove the screws→Remove the upper and lower air-duct board.→ Remove the inner air-duct board
→ separate the evaporator from the compressor and dry filter on the joints.

You can see the evaporator is joint to suction pipe and capillary. (Fig.7) Heat the joint E,G (Fig.17) in the compressor room, and disconnect the pipe from compressor by using the plier. Then remove the evaporator and capillary and suction pipe upward.

6.1.4. How to remove the display PCB

The process: remove the display supporter→ remove the display PCB

After removing the display supporter, from the back of the supporter pull the hooks, and remove

the display PCB. (Fig.8& Fig.8.1)

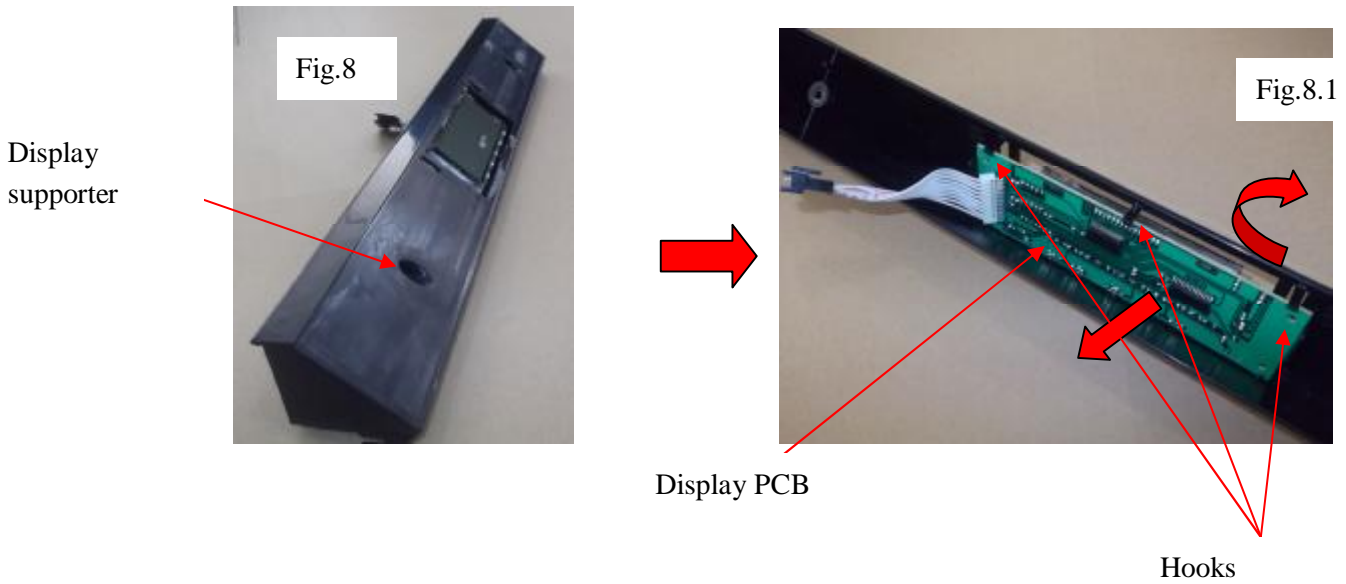

6.1.5. How to remove the inner fan

The process: Remove the shelves→Remove the control panel film→Remove the screws
→Remove the display supporter →Remove the middle electrical box→ Remove the screws→Remove the upper and lower air-duct board.→ Remove the inner air-duct board
→Remove the fan fixing screws→ Remove the fan

After remove the inner air-duct board, remove the fans fixing screws and we can remove the fan.(Fig.9)

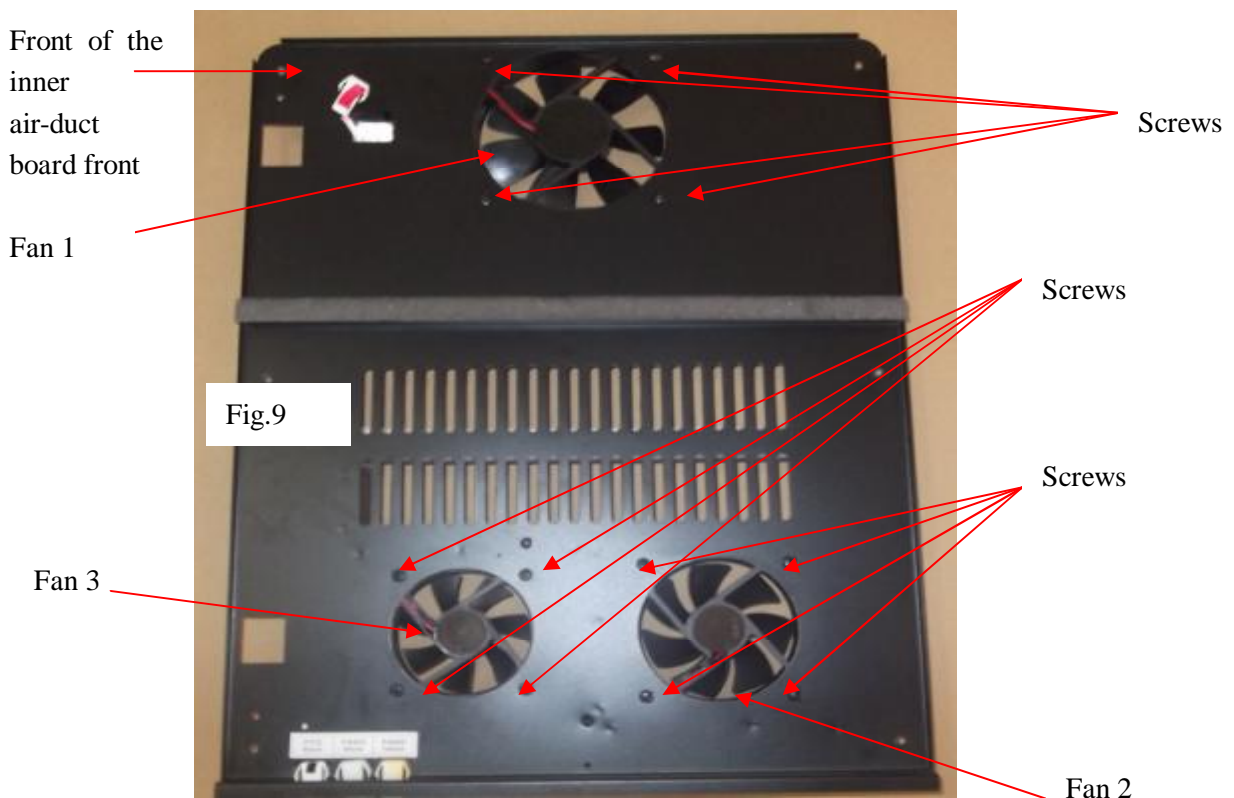

6.1.6. How to remove the heater

The process: Remove the shelves→Remove the control panel film→Remove the screws

→Remove the display supporter →Remove the middle electrical box→ Remove the screws→Remove the upper and lower air-duct board.→ Remove the inner air-duct board →Remove the heater fixing screws→ Remove the heater

After removing the air-duct board, the heater is on the back of it, remove the fixing screws and we can remove the heater. (Fig.10)



6.1.7. How to remove the defrost sensor and upper compartment sensor.

The process: Remove the shelves→Remove the control panel film→Remove the screws →Remove the display supporter →Remove the middle electrical box→Remove the upper air-duct board →remove the sensor cover →remove the sensor

1. Remove the upper air-duct board(A), pull out the two expanding nails(D), the sensor cover(C) loose, pull out the sensor (B). (Fig.11)

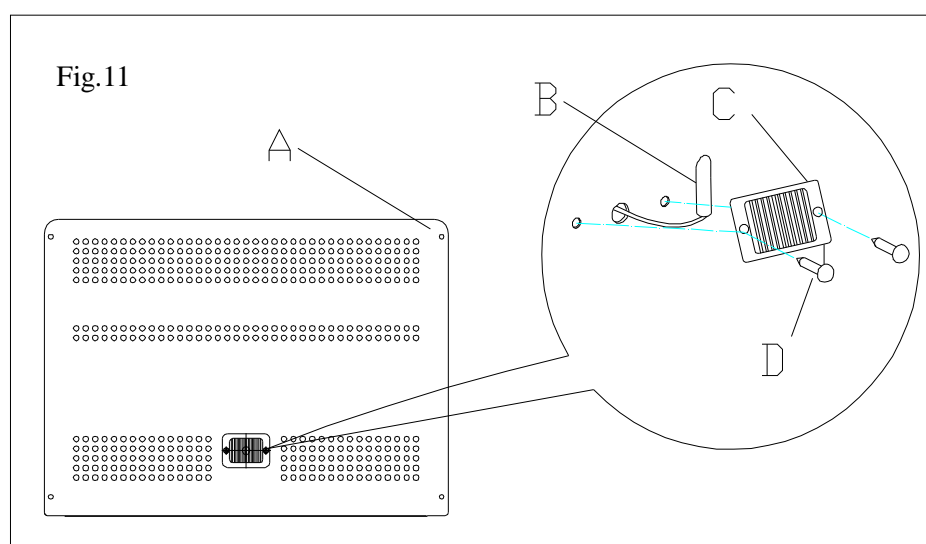

2.The process: Remove the shelves→Remove the lower air-duct board →remove the sensor

Remove the shelves, remove the lower air-duct board, we can see the lower compartment sensor, remove the sensor fixing screw and remove the sensor (Fig.7)

6.1.8. How to remove the LED light.

1. How to remove the lower compartment LED light.

The process: Remove the shelves→Remove the control panel film→Remove the screws →Remove the display supporter →Remove the PCB

①.Remove the shelves, peel off the control panel film, remove the middle electrical box. (Fig.2& Fig.3 &Fig.4)

②. Disconnect the connector, press the head of the nails one by one, pull the light PCB

upward, and we can remove the LED light. (Fig.12& Fig.12.1)

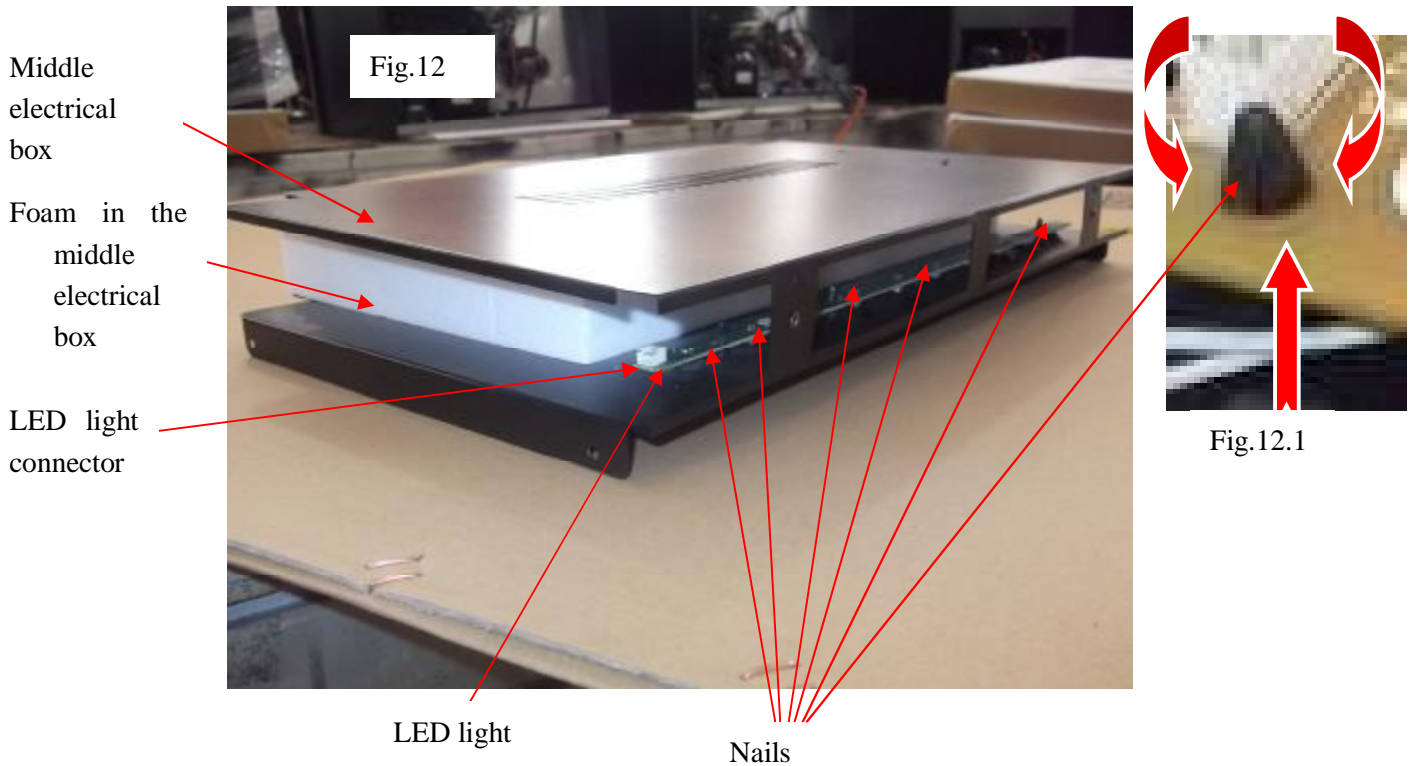

2. How to remove the upper compartment LED light.

The process: Remove the shelves → Remove the light cover fixing screws → Remove the light cover → Remove the LED light fixing screws → Remove the LED light.

- ①, Remove the shelves. (Fig.1)
- ②, Remove two light cover fixing screws, remove the light cover. (Fig.13)
- ③, Remove the LED light fixing screw in the middle of it, remove the LED light. (Fig.13.1)

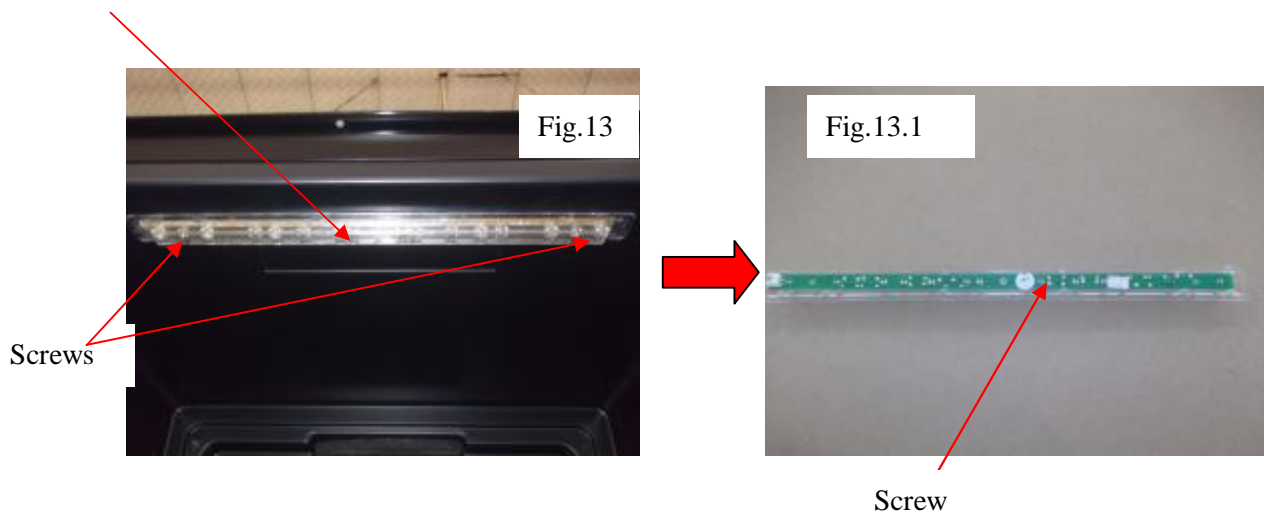

6.2 Gist on disassembly outside the cabinet.

6.2.1. How to remove the transformer.

The process of removing power box: Remove the screws fixing power box → remove the power box → Remove the transformer.

- ①. Remove four power box fixing screws. (Fig.14)
- ②. Remove the power box. (Fig.14.1)
- ③. Remove the two transformer fixing screws. (Fig.14.1)

Fig.14

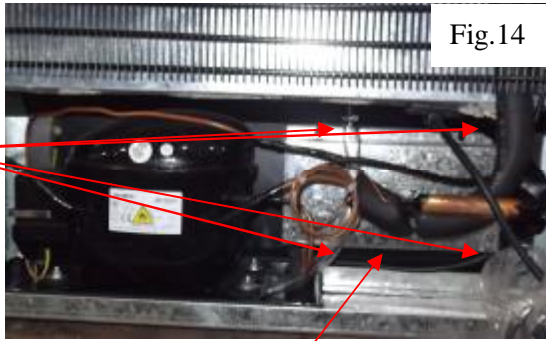
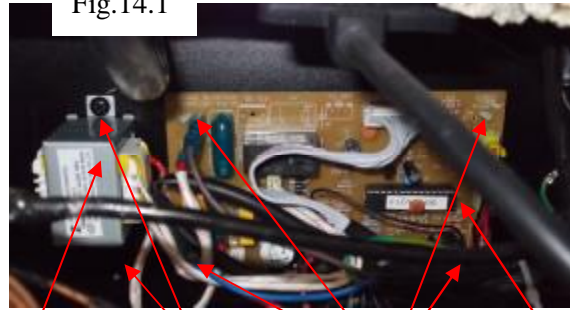

Fig.14.1



Screws

Power box

Transformer

Screw

Barbs

Main PCB

6.2.2. How to remove the main PCB.

The process of removing power box: Remove the power box → Disconnect the connectors on the main PCB → Remove the main PCB.

After disconnect the connectors, press the head of the PCB supporting nails one by one and remove the main PCB at the same time. (Fig.15)

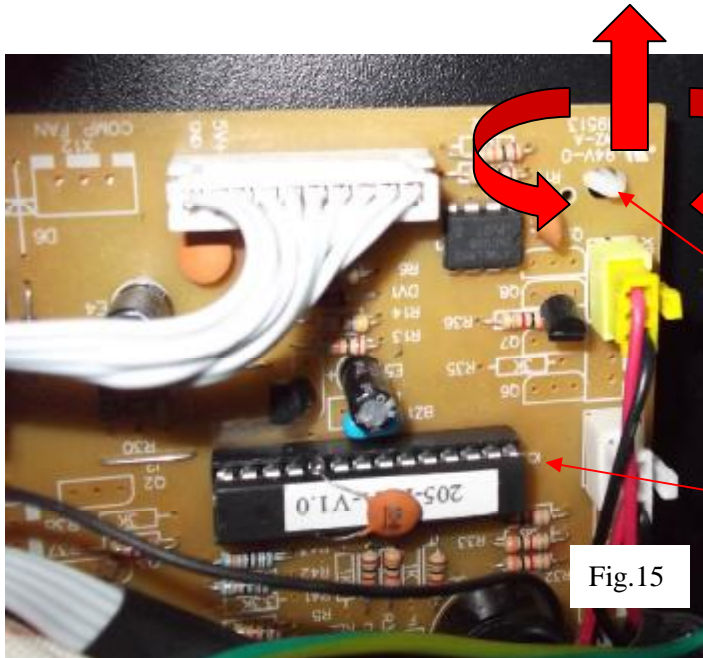

Four barbs fixing PCB

Main PCB

Fig.15

Diagram of main PCB connection. (Fig.16)

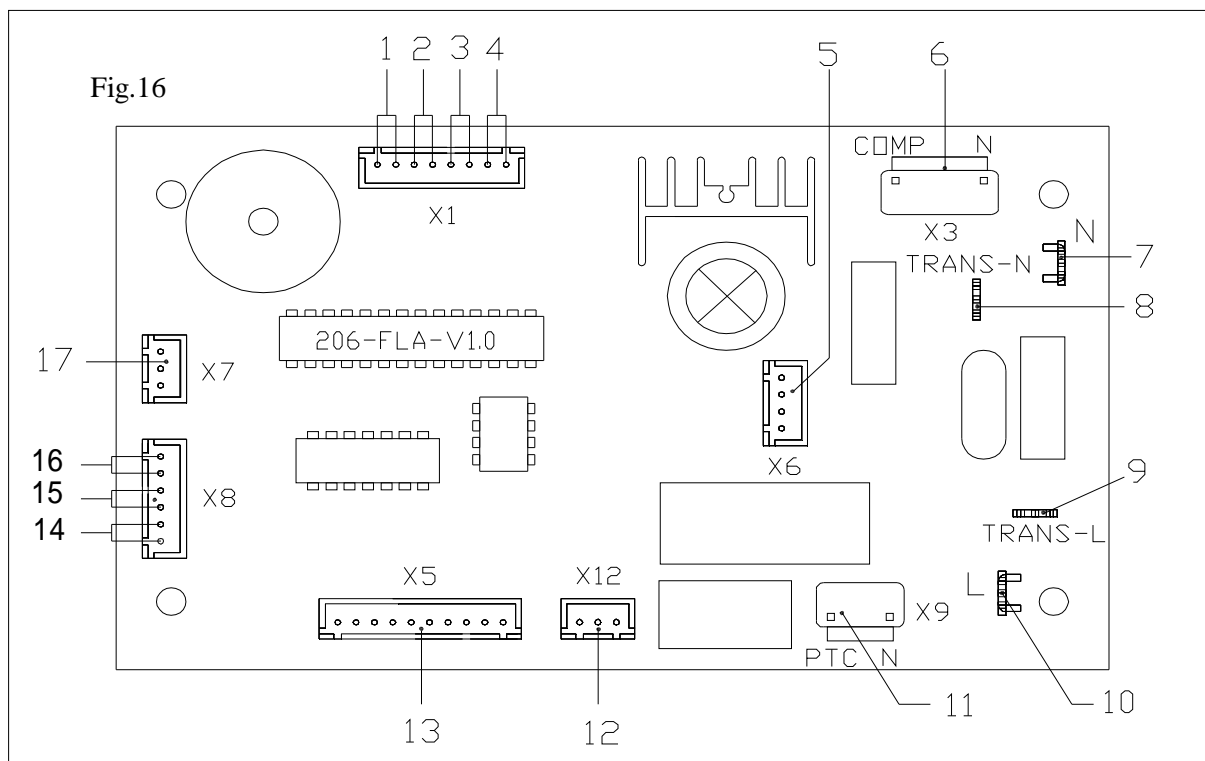

- | | | |
|------------------------|----------------------------------|----------------------------------|
| 1. Defrost sensor (T3) | 2. Lower compartment sensor (T2) | 3. Upper compartment sensor (T1) |
| 4. Door switch | 5. Transformer secondary | 6. Compressor |
| 7. Power - N | 8. Transformer primary - N | 9. Transformer - L |
| 10. Power - L | 11. PTC heater | 12. Outer fan (RED) |
| 13. Display PCB | 14. Upper fan (F1) | 15. Lower fan (F2) |
| 16. Heater fan(F3) | 17. LED light (WHITE) | |

6.2.3. How to remove the compressor

The process of removing the compressor: Remove the electrical cover of compressor → disconnect the connectors → separate the pipe connect to the compressor → remove the compressor

Heat E, F with soldering iron, and disconnect the pipes by using the plier. Remove the electrical cover of the compressor, and then remove four compressor fixing screws, remove the compressor. (Fig.17)

Diagram of rear soldering joints (Fig.17)

- | | | |
|--------------------------------------|-------------------------------|-----------------------------------|
| A: Jointing pipe and condenser joint | B: Process pipe joint | C: Electrical cover of compressor |
| D: Compressor | E: Suction pipe joint | F: Discharge pipe joint |
| G: Capillary joint | H: condenser and filter joint | I: Outer water tank support |
| J: Four condenser fixing screws | K: Condenser | |

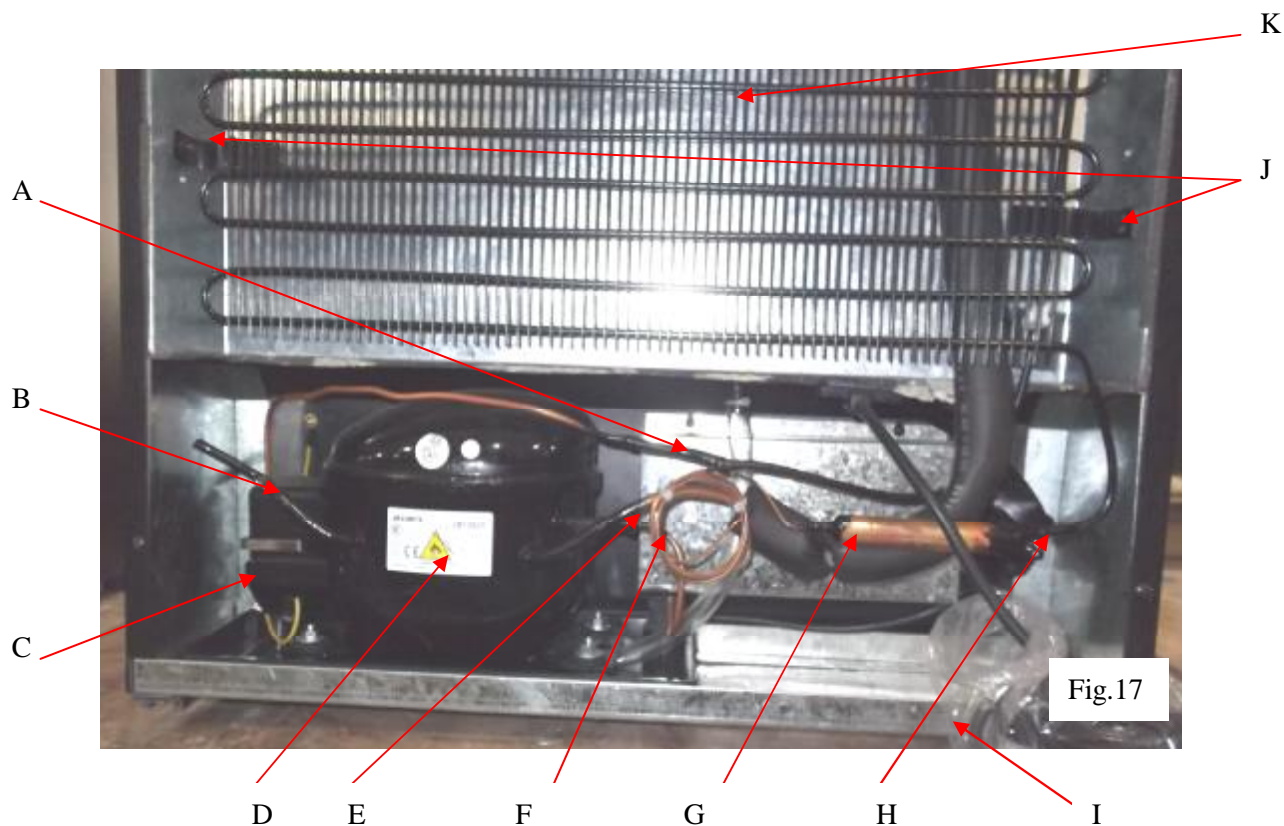

6.2.4. How to remove the outer condenser:

Process of removing the outer condenser: Remove four fixing screws → Remove the outer condenser

Separate on A, H by Soldering iron for copper pipes, separate the pipe using the plier, remove four screws J, remove the condenser K. (Fig.17)

7. How to overhaul the faults.

It should take approximate 3 hours to reach the lowest setting temperature of about 5°C (or 4 °C) for an empty unit (assuming ambient temp of 32 degrees centigrade and continuous operation). If not, check the compressor, cooling fans, controller, and sensors. If all these are working normally, there is probably a cooling pipe fault.

7.1. Check the compressor

If the wine cooler not cooling, check the current with the Amp meter, refer to rating label, if it too high or too low, cut the discharge pipe (Fig. 17 item F) and (Fig.12 item B), power on, check the current, and feel the discharge pipe, if the obvious air pressure from compressor, if the current still very high or very low or the discharge pipe with small air pressure, the compressor fault, replace the compressor please.

Notice. After cut the discharge pipe and process pipe, in case of suck the damp, the compressor should ne power on long time (no exceed 15 minutes is best).

7.2. Check the cooling system

When it is sure that the compressor is working normally and the cooling system's fault is concentrating on the cooling system pipe. Check following below:

- 1>. Cut off process pipe and check the refrigerant. If there is not enough refrigerant, the default of the refrigerant system should be caused by the leaking. If the refrigerant is sufficient., it is probably block in the capillary.
- 2>. If the default is concentrated on the cooling system, the checking procedure is as below.
 - a. Cut off the discharge pipe (See Fig.17 item F) of the compressor, and infuse 0.8-1.5 MP nitrogen per process pipe, and put the hand close to the cut kerf. If there is a little gas leak from the terminal, it means normal, otherwise it is jammed.
 - b . Make sure the capillary is working normally. Then reconnect the discharge pipe, and infuse 0.8-1.5 MP nitrogen from process pipe, then test the leakage, check with soap water if the cooling system of the soldering point is damaged. Check from the soldering points around the compressor(Fig.17), if it is OK, then check the soldering point of the evaporator(Fig.7), before check please remove the air-duct board, please see the remove method and procedure in (→6.1.2)
 - c. If all the soldering point in b is not leaking, there are two possibility, one is leakage in the inner condenser (or anti- dew pipe), another is the damage on the spare parts in the cooling system. If it is the inner damage, it can not be repaired, and if the damage on the spare parts, replace them.
- 3>. Make sure the systems is not any leakage, refill it.

7.3. Refill the refrigerant:

- 1>. Using the vacuum pump form a vacuum in the system, via the joints of the high/low-pressure pipe, the low-pressure pipeline is on the process pipe of the compressor (Fig.17 showing B), high-pressure pipeline is on the process pipe of the filter. Apply the vacuum pump for approximately 20 minutes. Until the vacuum is lower than 100Pa. Then solder the process pipe of the filter. Keep the vacuum running while soldering this joint
- 2>. Fill Cooling system with refrigerant via the process pipe of the compressor (Fig.17 showing B). (Regarding refrigerant quantity Please refer to the instruction at back label of wine cellar). Then solder the compressor process pipe after the system is charged with refrigerant.

7.4. Running test:

After the procedures above finish, turn the unit on. To verify the effectiveness of the repair, monitor the unit, the compressor should automatically stop within + or - 2.5 deg centigrade of the set temperature within approx 3 hours (assuming an ambient temperature of 32°C and the unit is empty).

7.5. Noise problem

1 Compressor noise

- 1>. The working of motor and piston motion will cause noise when compressor working. So if noise is steady and not exceeds 42 dB, it's normal. If noise is not steady or very high, it's compressor fault and it should be maintained or replaced. (→6.2.3)
- 2>. If compressor's shock absorption rubber is hardening or damaged, or fixing screw of compressor is too tight or loose, it will cause noise. The settlement is to change new shock absorption rubber or adjust fixing screws. (→6.2.3)

2 Fan noise

- 1>. When the fans are running , the vanes are circumrotating rapidly and the air flows, which will cause steady and standard noise. The noise should not exceed 32dB and it is normal.
- 2>. If the noise is extremely high and abnormal, replace the default fan please. (→6.1.5)

7.6. Refrigerant jet noise

Default: There is continuous noise like a water spray from the capillary.

Reason: The end of the capillary is in the wrong position, or there are rough edges on the end of the capillary

Solution:

- 1>. Remove the evaporator (→6.1.3), heat the soldered joint of the capillary (Fig.7), then remove the capillary from the evaporator and smooth the end with an eraser. (Caution: do not allow any particles into capillary unit).
- 2>. Replace the capillary into the evaporator, then solder it back into the correct position (not exceeding 15mm in the evaporator) and pack the joint with anti vibration compound
- 3>. Recharge with refrigerant. (→7.3)

7.7. Capillary vibration noise

Default: high frequency impact noise in capillary Zone.

Caused by either reason below:

- 1>. The capillary being insert too deep into the evaporator, so when the refrigerant is Jetting, the end of vibrating capillary will hit the inside of the evaporator.
- 2>. Vibration from the capillary touching the inside of the cabinet or air duct board, then when refrigerant is jetting.

Solutions:

- 1>. Refer to (→7.6)
- 2>. If the capillary touch the inner cabinet and the air duct panel, adjust the position of the capillary and add the incabloc plastic.

7.8. Oil jammed noise

Fault: intermittent and deep jet noise coming from inside of the capillary.

Cause: Compressor oil flowing into the cooling system pipe work probably due to the capillary slightly out of alignment during transportation

Solution: Clean the cooling system pipe, vacuumize it and recharge with refrigerant see (→7.3)

7.9. Evaporator freezing.

Because the door seal is not air-proof, or the door is not closed well, cause much water fill in the cabinet, and the water got frozen when it encounter the cold air, sometimes the ice is too thick, and it will block the fan or broken the fan.

The solution:

- 1 >. Replace the door seal or close the door well. If the door seal is slightly not air-proof, it can be repaired by the heat dryer.

Aiming at the distortion of the seal with the heat dryer, and move up and down until it expand to the normal state. When it is cool, check it with the door closed, if there is any distortion, dry it again until it fix for the door. (Fig.18)

2 >. If the fan is broken, replace the fan.



7.10. Unstable temperatures inside the cabinet.

The unstable temperature is caused by the evaporator fans cease, and it can be check by the below method: When the compressor is running, the light “Run” is on, the fan should be running, if the fan stop, check the whether is any fault in the fan or fan connection. If the fan is broken, replace it with the fan of the same model . (→6.1.4)

7.11. The digital display’s fault

This malfunction is caused by the display panel’s default, replace with the same model’s display panel. (→6.2.1)

7.12 Door switch fault .

1 >. Check if the X1 well connected (Fig.16) , if it ok, replace the switch please.

2 >. Remove the switch box fixing screws, and cut the switch. (Fig.19& Fig.19.1);

3 >. Peel off the scarfskin on the end about 12mm, cut the spare switch and peel off the scarfskin, connect the ends and wrap the ends with insulating tape.(Fig.20& Fig.20.1)

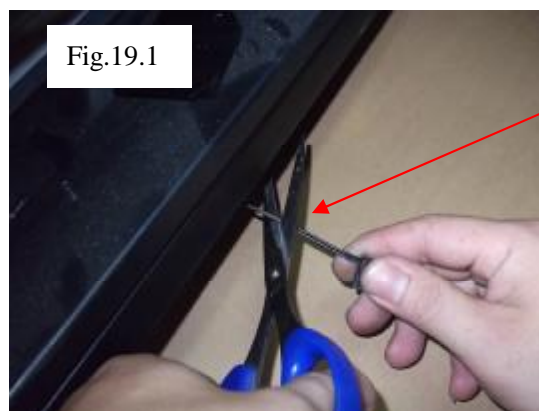
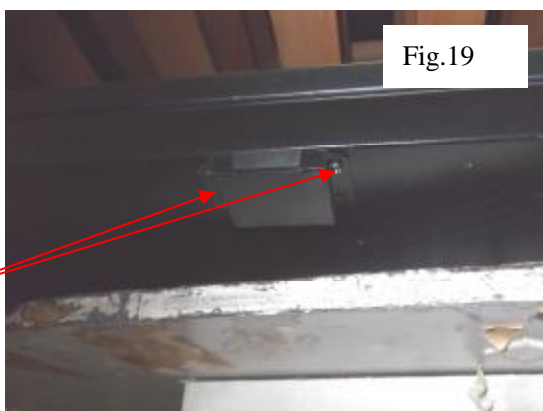

Screws

Scissors