



# WC6112

Caple 60cm in-column wine cabinet



**Technical information**

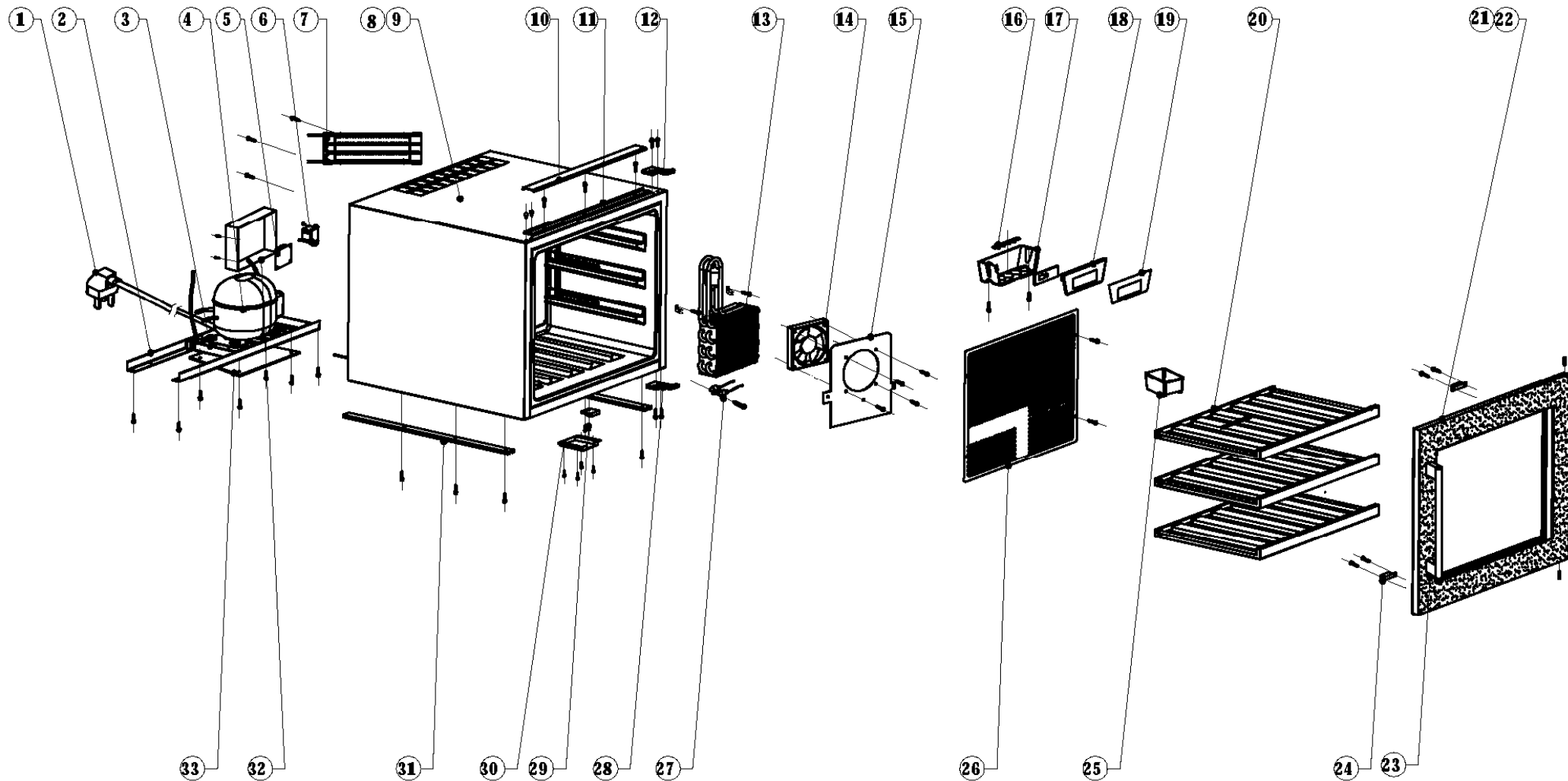

**caple**

**WC6112**

Caple 60cm in-column wine cabinet



## WC6112 - Caple 60cm in-column wine cabinet

Item	Part Code	Description	Qty
1	DG2-14	Power cord	1
2	DG22-476	support bar of tank water	2
3	DG13-447	water box	1
4	DG1-72	Compressor	1
	QP2-22		1
	BB35-125 DRB-16N61A1		1
5	DG3-205	PCB board	1
6	DG6-7	Transformer	1
7	DG12-91-1	Condenser	1
8	DG26-125	Cabinet	1
9	DG13-268	Decorative nail	2
10	DG13-473	limiting bar(B)	1
11	DG13-472	limiting bar(A)	1
12	DG14-206	Top hinge module	1
13	DG12-44	Evaporator	1
14	DG7-33-H	Evaporator fan	1
15	DG22-480	fixing board for fan	1
16	DG3-207-1-W	LED light	1
17	DG13-471	Electrical box	1
18	DG13-470	lid of electrical box	1
19	DG20-260	Display panel	1
20	DG15-204-1	Wooden shelves	1
	DG15-204	Wooden shelves	2
21	DG23-209	door	1
22	M147-003	gasket	1
23	DG22-3109	handle	1
24	DG13-3005	magnet	2
25	DG13-1.2	Humid box	1
26	DG22-472	Air duct board	1
27	DG20-1	wire clamp	2
	DG8-22	Senser	1
	DG8-23	Senser	1
28	DG14-207	Lower hinge module	1
29	DG13-3004	reed switch	1
30	DG22-3014	lid of reed switch	1
31	DG13-474	support bar	2
32	DG22-479	Electrical box cover	1
33	DG22-473	strengthening board	1

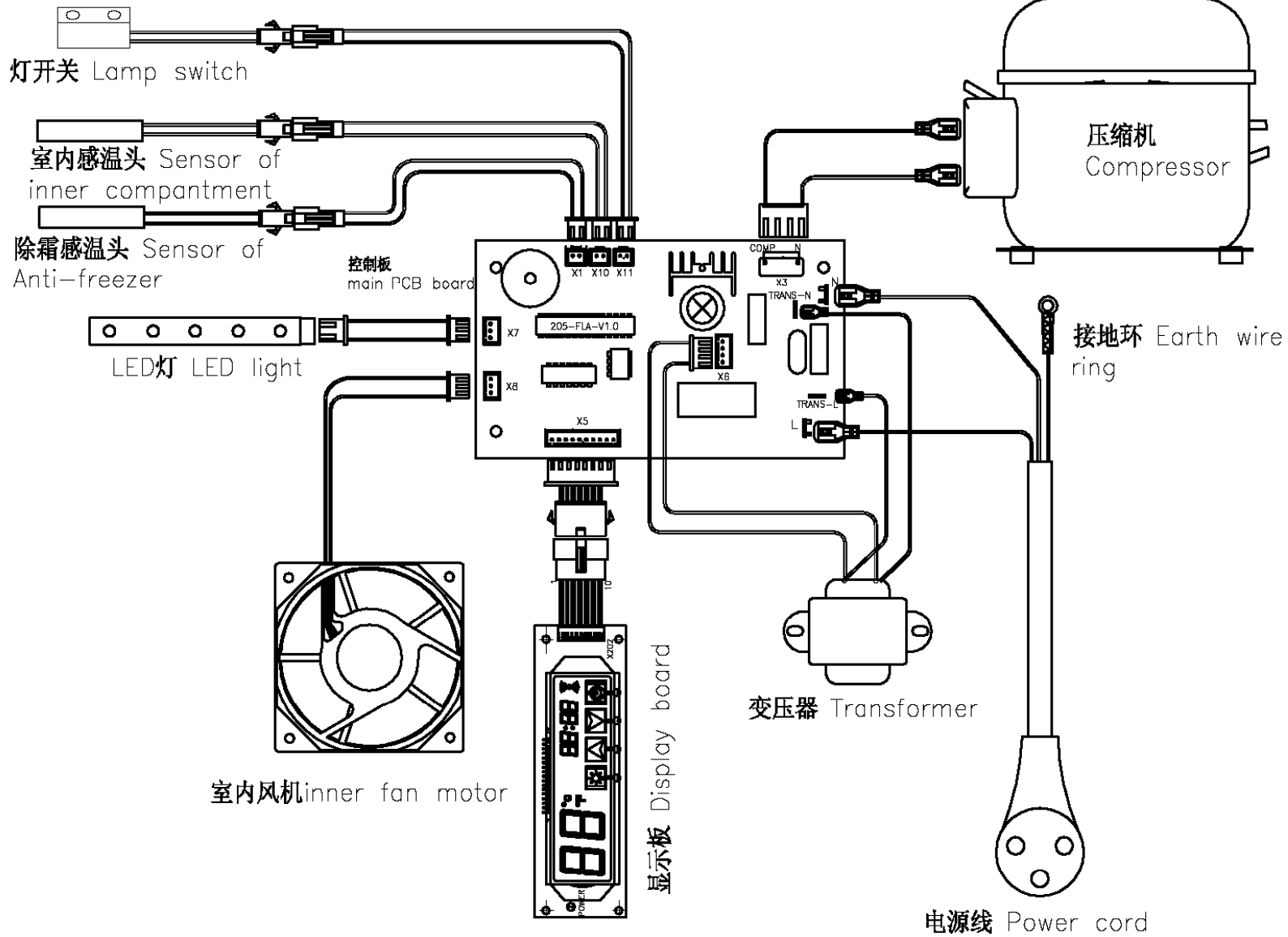

**caple**

**WC6112**

Caple 60cm in-column wine cabinet

8 7 6 5 4 3 2 1

D

C

B

A

# Computer Controlled Wine Cellar

WC6111 WC6112

## Service Manual

Here below we listed various faults while using the wine cellar, and the method of check-up and solve these default, and find the information of the correspondent page.

---

Statement: (Fig.4 ) shows the reference figure Fig4

( →6.1.6 ) shows the reference item 6.1.6.

**Warning: before attempting any cleaning or maintenance this unit MUST be disconnected from the electrical supply, to prevent electrical shock**

### ▲Preparation before maintenance

#### ○ Tools

- |   |                                |
|---|--------------------------------|
| 1 . Pliers                              | 2 . Phillips head screwdrivers |
| 3 . Process pipe                        | 4 . Electrical Multi meter     |
| 5 . Amp meter (5A) (caliper cable type) | 6 . Electrical soldering iron  |
| 7 . Wire strippers                      | 8 . Seal pliers                |

#### ○Equipment

- |                 |                                     |                      |
|-----------------|-------------------------------------|----------------------|
| 1 . Vacuum pump | 2 . Soldering iron for copper pipes | 3. Refrigerant meter |
|-----------------|-------------------------------------|----------------------|
- 

- |   |       |   |
|---|-------|---|
| 1. Safety rules on operation of repairing.(Rules must be obeyed). | —     | 2 |
| 2. Electrical circuit diagram.                                    | _____ | 4 |
| 3. Cooling system diagram.  | _____ | 5 |
| 4. Name and function on control panel.                            | _____ | 5 |

5. How to diagnose the fault. _____	6
6. Gist on disassembly. _____	8
7. How to maintain the default. _____	14



### 1. Safety rules on operation of repairing (Rules must be obeyed).

To avoid the accident during maintain the wine cooler, and make sure the product is safety, rules must be obeyed list below.

- Below we list the symbols and explain the danger if ignore it.

	<b>Danger</b>	This symbol means that the instance may have the chance to suffer death or a serious wound.
	<b>Warning</b>	This symbol means that the instance may have the chance to suffer death or a serious wound.'
	<b>Notice</b>	This symbol means that the instance may have the chance to suffer a wound.'

- Below symbols' distinguish and rules should be obeyed.

	This symbol means the instance hope to be noticed		This symbol means the instance must be done forcibly
 禁止	This symbol means the instance forbidden		



## Danger



- Please make sure to discharge the rest refrigerant in the parts.
- When discharging refrigerant, make sure that it never go to the fire place and drain to outdoors.
- Tell the customers that they never close to the discharge place and the fire is forbidden.
- Take apart the pipe by cutter.
- Never take apart the part by soldering, otherwise it will fire the rest refrigerant in the systems and cause blast.
- Exhaust the rest refrigerant in the systems before welding.
- After filling the refrigerant the sealing should be done by using smithing welding nozzle.
- Using the welding machine will fire the refrigerant and blast.
- Since the R600a is heavier than the air, please let the R600a on the ground go especially for the hypogeum.
- The operation on the servicing refrigerant bottle should be done in place without fire and outdoors.
- Use the refrigerant warner please , as the rest refrigerant will cause the fire.



禁止

- Don't use fire in the place with rest refrigerant.
- Don't place the default compressor in indoor.



## Danger



拔掉电源  
插头

·During repairing, the power plug should be disconnected.

Before remove, install, replace parts disconnect the power plug.



小心触电

·Attention don't get electric shock.

When checking current, voltage or charging never touch the connectors.

When changing the parts, don't touch the charged parts within three minutes after disconnect the plug.

The capacitor will discharge for some time.



禁止

·Don't damage the cooling pipe, sine the refrigerant is flammable, the damage will cause the fire or blast.

·Don't smoking in the service car.



·Discharge the refrigerant entirely in the place without fire before disusing the refrigerant bottle.

·Don't touch the wine cooler when the cooling pipe damaged, don't fie inside the wine cooler, keep the windows open to exchange the air.

·Disusing the default compressor should be done outdoor without fire.

·The maximum weight of the refrigerant bottle loaded in the vehicle should be comply to stated, the bottle should be place upright, the maximum leaning angle is 40°.

·Do use the appointed part, otherwise it have chance to smoke fire or default.

·Please put the default compressor into plastic bag and seal the peristome, then pack it with strip, as the rest compressor oil may leak in the vehicle and cause fire or blast.

·Check if all the snails, parts, wiring are install in it's place, if the area around the service part worsen.

When measuring the grounding resistance make sure that the test range is more than

	<p>1MΩ.</p> <p>Make sure the power cord and plug never be pinched on rear of the wine cooler.</p> <p>Exchange the power cord when it damaged.</p> <p>Clean the flake of the plug when it dirty.</p>
--	---



## Notice

 注意高温	<ul style="list-style-type: none"> <li>·Attention the hot.</li> <li>The running or just stop compressor and the pipe sometimes are very hot. And the heating or just stop heater is very hot. The hot will cause scald.</li> <li>·Attention the hot parts of the pipe after the welding.</li> </ul>
	<ul style="list-style-type: none"> <li>·Attention the refrigerant during charge and discharge it, as it will frostbite the skin when touch it.</li> <li>·Attention the burr.</li> <li>The burr on the metal or plastic part may hurt the hand.</li> <li>·Attention the fins of the evaporator.</li> <li>The fins of the evaporator may hurt the hand.</li> </ul>
	<ul style="list-style-type: none"> <li>·Drive up the wine cooler when moving it. Pushing it may damage the floor. Cover a protector board on the easy damage floor.</li> </ul>

## 2. Electrical circuit diagram.

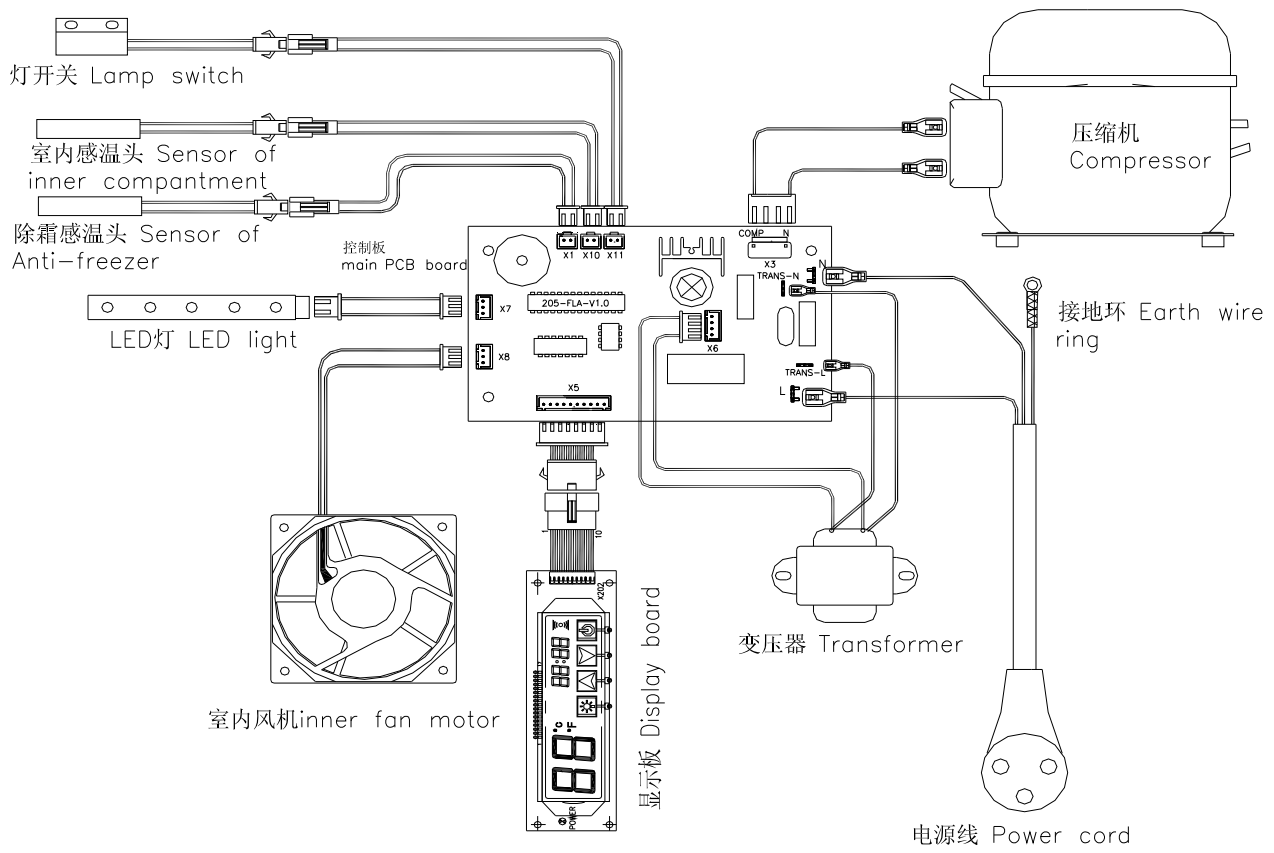

## 3. Cooling system diagram.

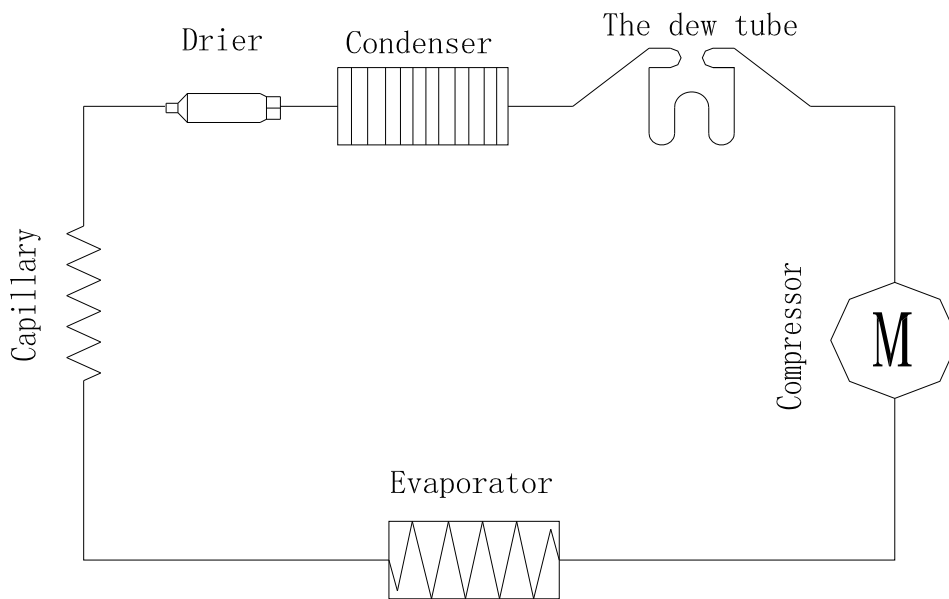

#### 4. Name and function on control panel.

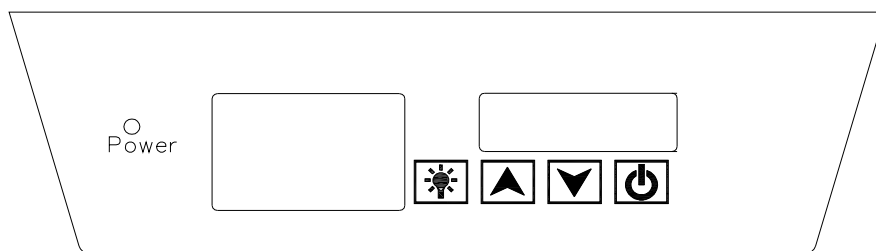

- “▲” Press ‘▲’ , the setting temp will raise up in 1.
- “▼” Press ‘▼’ , the setting temp will lower down in 1.
- “💡” Press one time, the light on, press again, the light off, it is not effect by the door switch. Press it and hold on for three seconds will enter the time adjustment. Press ‘▲’ adjust the hour, press ‘▼’ adjust the minute.
- “🔌” Press it one time, the power on, press it and hold on for three seconds, the power off.
- “Power” Power on/off indication light.
- The default setting temp of this wine cooler is 12, but when restart the wine cooler after power off, it will back to the former setting temp before power off.
- According to customers’ requirement, this wine cooler can be set to that the readout display actual temp or setting temp.
  - a. In the readout display actual temp mode, press the ‘▲’ or ‘▼’, the systems enter the temperature setting mode and the setting temperature twinkling. Five seconds twinkling after stopping adjust temperature, the readout stop twinkling and the readout show actual temperature, the temperature setting mode end.

b. In the readout display setting temp mode, press the '▲' or '▼', the systems enter the temperature setting mode and the setting temperature twinkling. Five seconds twinkling after stopping adjust temperature, the readout stop twinkling and the readout show setting temperature, the temperature setting mode end.

## 5. How to diagnose the fault.

### 5.1 Fault finding by the self-check mode.

The wine cooler is controlled by computer, in order to maintain the wine cooler easily, there is a self-check function in the control PCB.

If you suspect that the control system fault, you can star the self-check mode by following below:

1 > . Power on the wine cooler, it will beep one sound, the wine cooler star, within 10 seconds after it star, press the '▲'and'▼'at the same time and holding, three beep will sound, the systems enter self-check mode.

The power indication light is on.

The readout show the actual temp.

The inner fan running.

No response when press the controlled buttons.

2> . If all items tally with above description, the parts are normal. If any part fail, check the failed part and the corresponding wiring and connection, if the wiring and connection is in good condition, replace the part and check again, if it still failed, the default should be the control PCB, replace it with same model. ( →6.2.1)( → 6.2.2)

3 > . The self-check can be quit only disconnect the power plug.

### 5.2 Err code

Code	Representation	Checking point	Solution
E1	Inner sensor open circuit.	Check the wiring and connection between PCB and sensor, if it open circuit.	If the connection and wiring is normal, replace the sensor please.
E2	Inner sensor short circuit.	Check the wiring and connection between PCB and sensor, if it short circuit.	If the connection and wiring is normal, replace the sensor
E3	Anti-frost sensor open circuit.	Check the wiring and connection between PCB and sensor, if it open circuit.	If the connection and wiring is normal, replace the sensor
E4	Anti-frost sensor open circuit.	Check the wiring and connection between PCB and sensor, if it short circuit.	If the connection and wiring is normal, replace the sensor
HI	Inner temperature too	a Check if any refrigerant leakage.	Repair the leakage and refill.

	high	b Check it the capillary jam	Clean or replace the capillary.
		c Check it the inner fan run normally	Repair the wiring or replace the fan.
LO	Inner temperature too low	a Check it the inner fan run normally	Repair the wiring or replace the fan.
		b Check it the PCB normal.	Replace the PCB.

High temperature warning—After turning on the wine cooler ten hours, if the inner temperature is over 23°C, the readout show HI, after it showing for one hour, the readout twinkling and the buzzer alarm, and twenty minutes later, the buzzer stop, the compressor stop, the readout keep twinkling. The HI alarm can be stopped by disconnect the power plug.

Low temperature warning—After turning on the wine cooler two hours, if the inner temperature is lower than 0 °C and lasting for 15 minutes, the readout show LO, the buzzer alarm, and the compressor stop at the same time, when the inner temperature is over 2°C, the LO warning stop.

\*Remark: some models without the HI and LO warning function.

### 5.3 Diagnose the default

#### •There isn't any display on the display PCB.

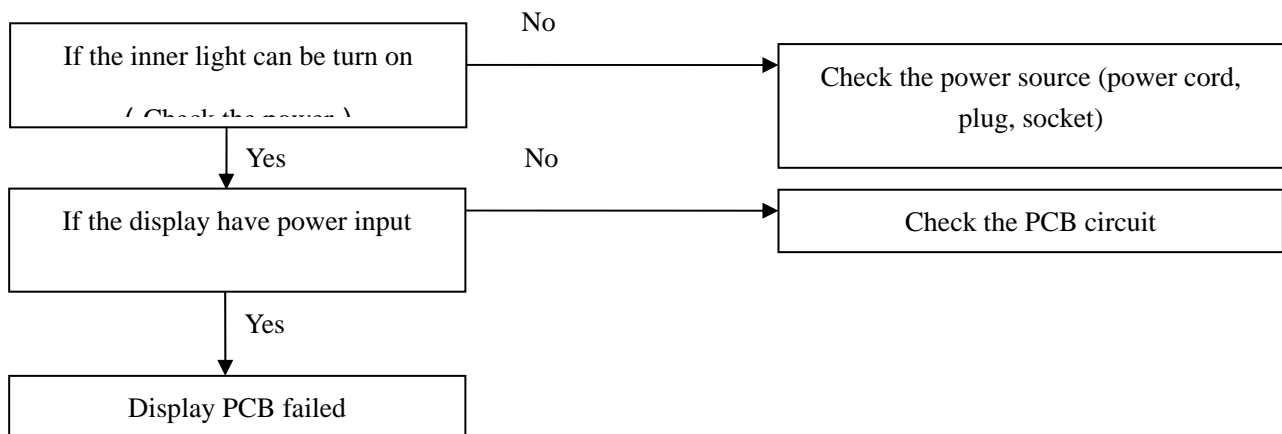

#### •Not cooling (the compressor stop)

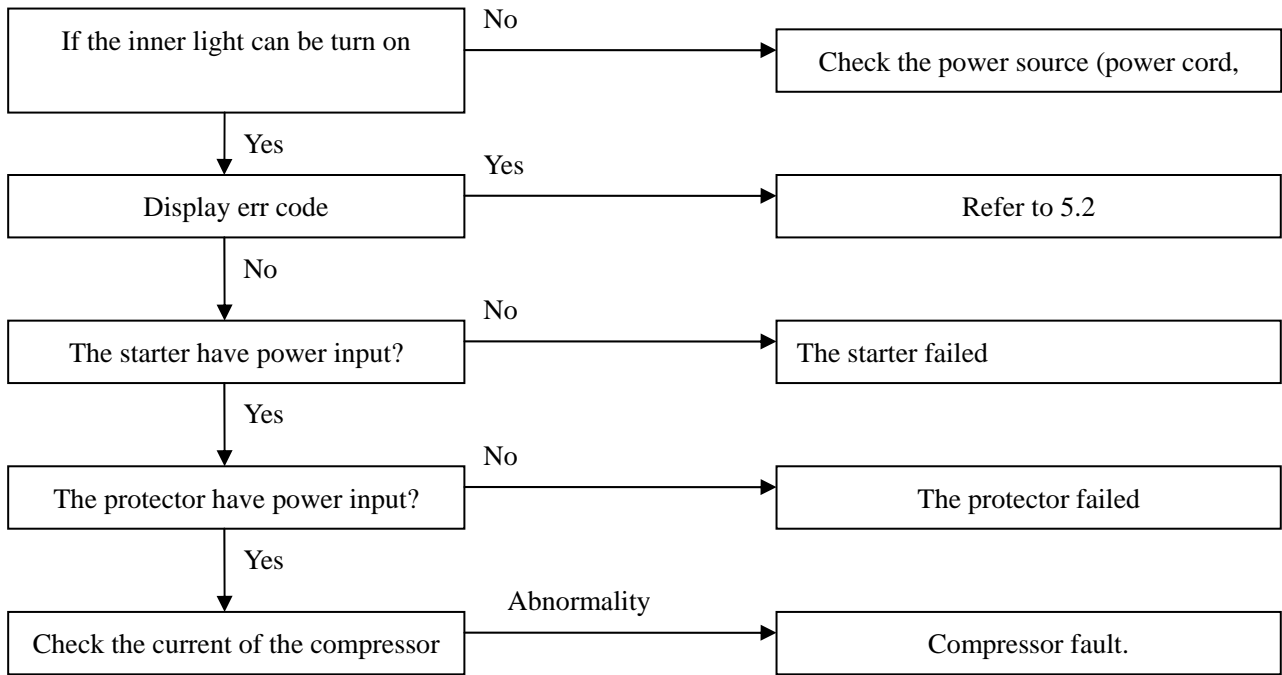

**•Not cooling (the compressor running)**

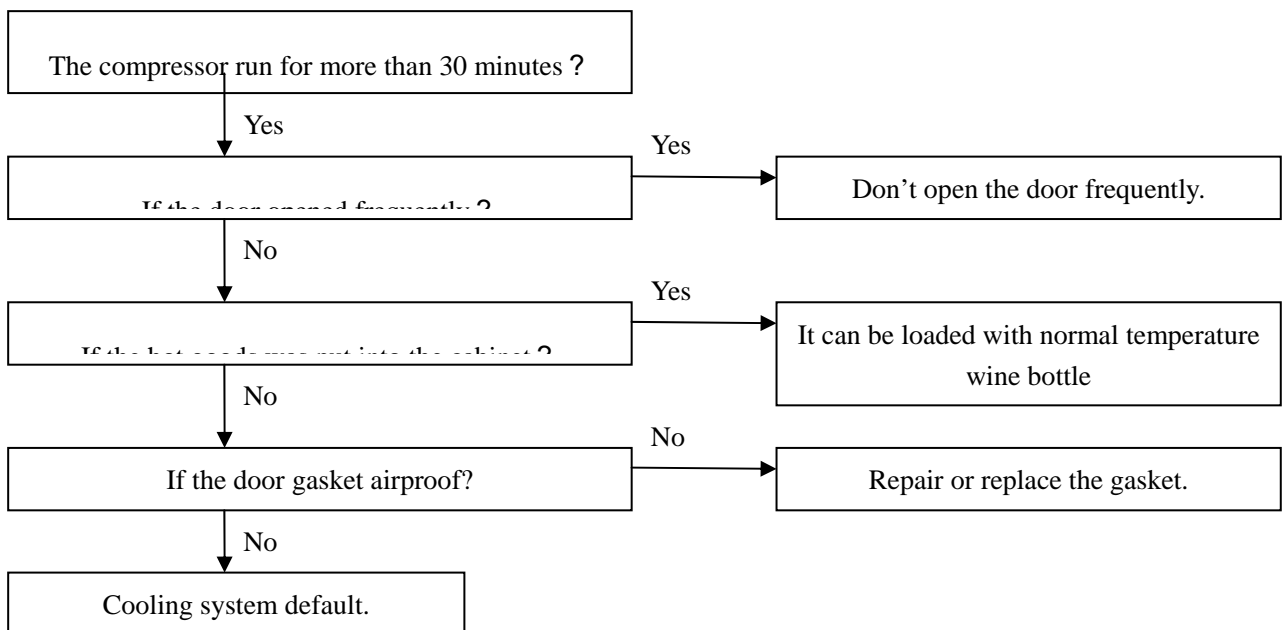

## 6. Gist on disassembly.

Warning: Disconnect the power plug before maintain the wine cooler.

### 6.1 Gist on disassembling the inner cabinet.

#### 6.1.1. How to remove the shelves.

Push the shelf to the end, and revolve the shelf on either side, make the stopper on the out of the guiding rail, then pull the shelf out(Fig.1).



#### 6.1.2. How to remove the air-duct board

The process of removing the air-duct board: Remove all shelves → Remove the air-duct board

1> Remove the shelves, remove the screws fixing the air-duct board, remove the air-duct board, can see the inner air-duct board. (Fig.2& Fig.2.1)

Air-duct board

Screws fixing the air-duct board

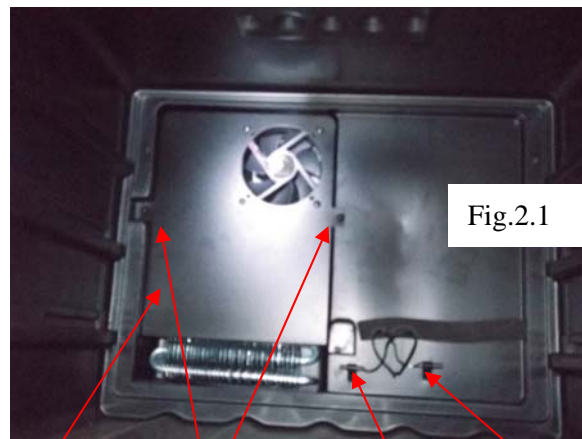
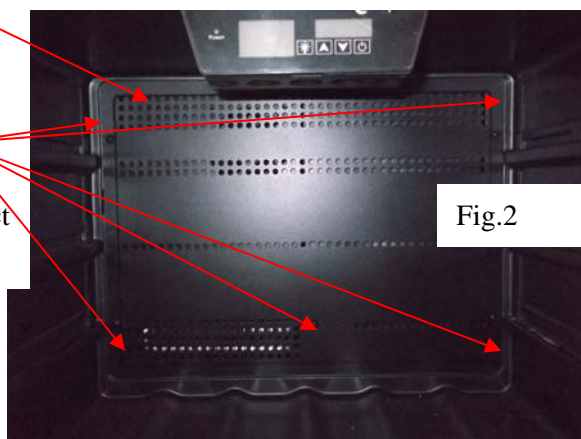

Inner air-duct board

Screws fixing the inner air-duct board

Anti-frost sensor

Inner sensor board

2>.Remove the screws fixing inner air-duct board, disconnect the connector of the fan, and remove the inner air-duct board, we can see the welding points around the evaporator. (Fig.3 )

Diagram show evaporator room.

A: Capillary joint

B: Evaporator joint

C: Fan connector

D: Evaporator

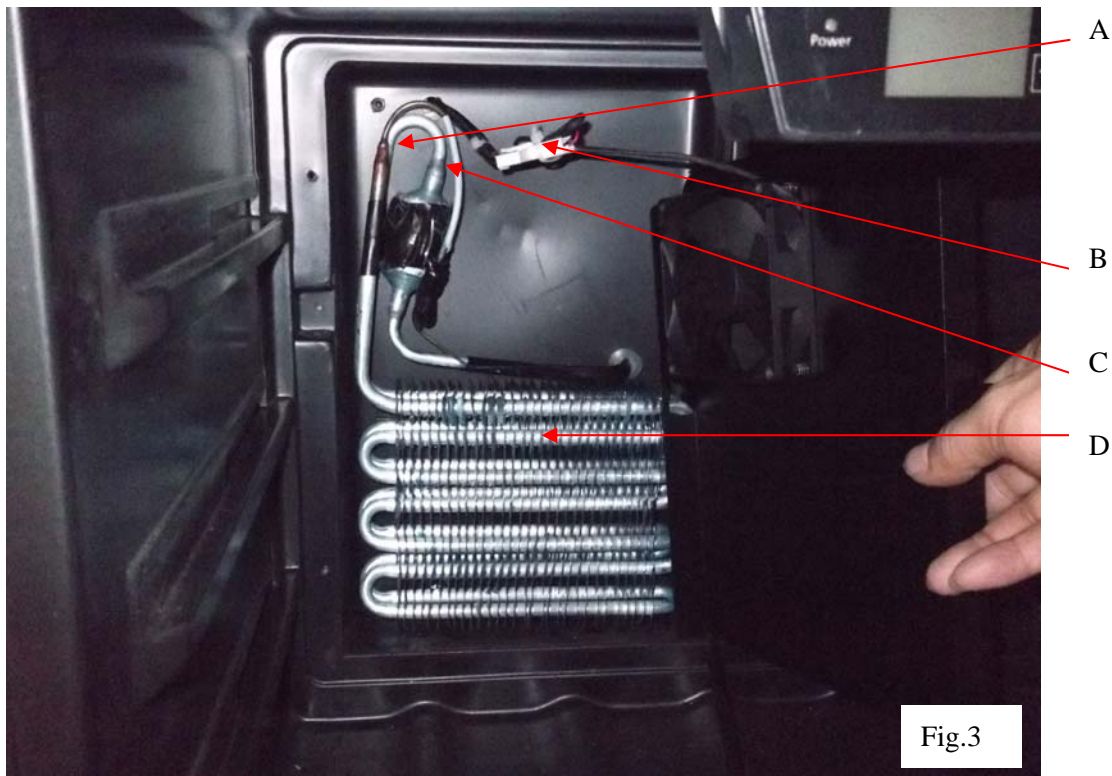

### 6.1.3 . How to remove the evaporator

The process of removing the evaporator: remove all shelves→ remove the air-duct board  
→ remove the inner air-duct board→ separate the evaporator from the compressor and  
dry filter on the joints.

You can see the evaporator is joint to suction pipe and capillary. ( Fig.3 ) Heat the joint C,E  
( Fig.12 ) in the compressor room, and disconnect the pipe from compressor by using  
the plier. Then remove the evaporator and capillary and suction pipe.

### 6.1.4. How to remove the inner fan.

The process of remove the inner fan: remove all shelves→ remove the air-duct board →  
remove the inner air-duct board→ disconnect the fan connector→ remove the fan

Remove the inner fan fixing screws, remove the inner fan ( Fig.4 )

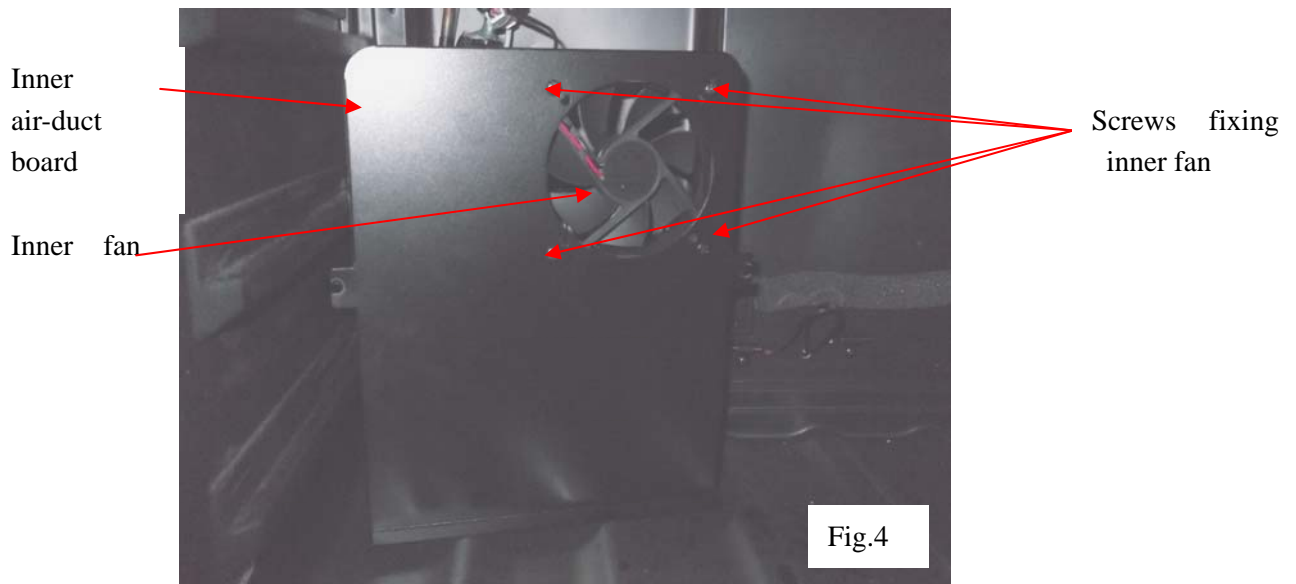

### 6.1.5. How to remove the electrical box

The process of removing the electrical box: Remove all shelves → loose the fixing screws → disconnect the connectors → remove the controlled box

Remove the shelves (Fig.1); loose the fixing screws and the box loose, disconnect the connectors, then remove the electrical box.



### 6.1.6. How to remove the display board

The process of removing the controlled box: Remove all shelves → loose the fixing screws → disconnect the connectors → remove the controlled box → remove the display PCB

1>. Disconnect all connectors, remove the controlled box, prize the clasp to take the front cover with display PCB by using the slotted screwdriver. (Fig.6)

2> . Remove four screws fixing display PCB, take away the display PCB. ( Fig.7)

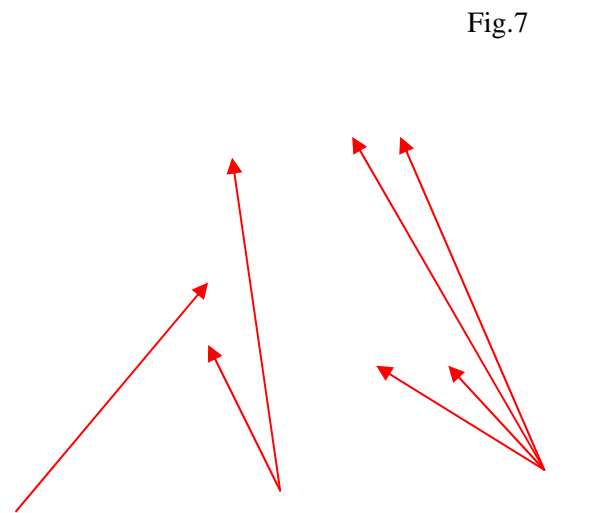
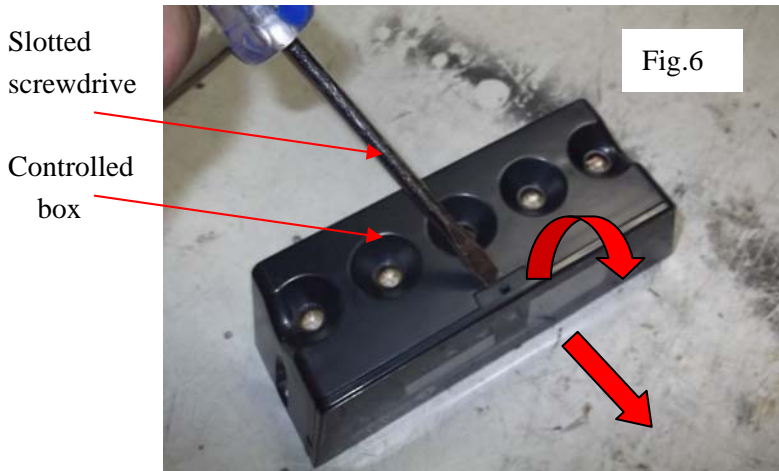

front cover

LED light

Screws

Screws

### 6.1.7 . How to remove the LED light

The process of removing the LED light: Remove all shelves → loose the fixing screws → disconnect the connectors → remove the controlled box → remove the LED light

Remove the electrical box, then remove the screws fixing LED light, remove the LED light.(Fig.6 & Fig.7 )

## 6.2 Gist on disassembly outside the cabinet.

### 6.2.1 . How to remove the power box and transformer.

The process of removing power box: Remove the screws fixing power box → remove the power box.

The process of removing transformer: Remove the screws fixing power box → remove the power box → remove the transformer.

- ① . Remove the screws 1, 2 fixing power box.( Fig.8)
- ② . Remove the power box.( Fig.9)
- ③ . Remove the screws fixing transformer. ( Fig.9)

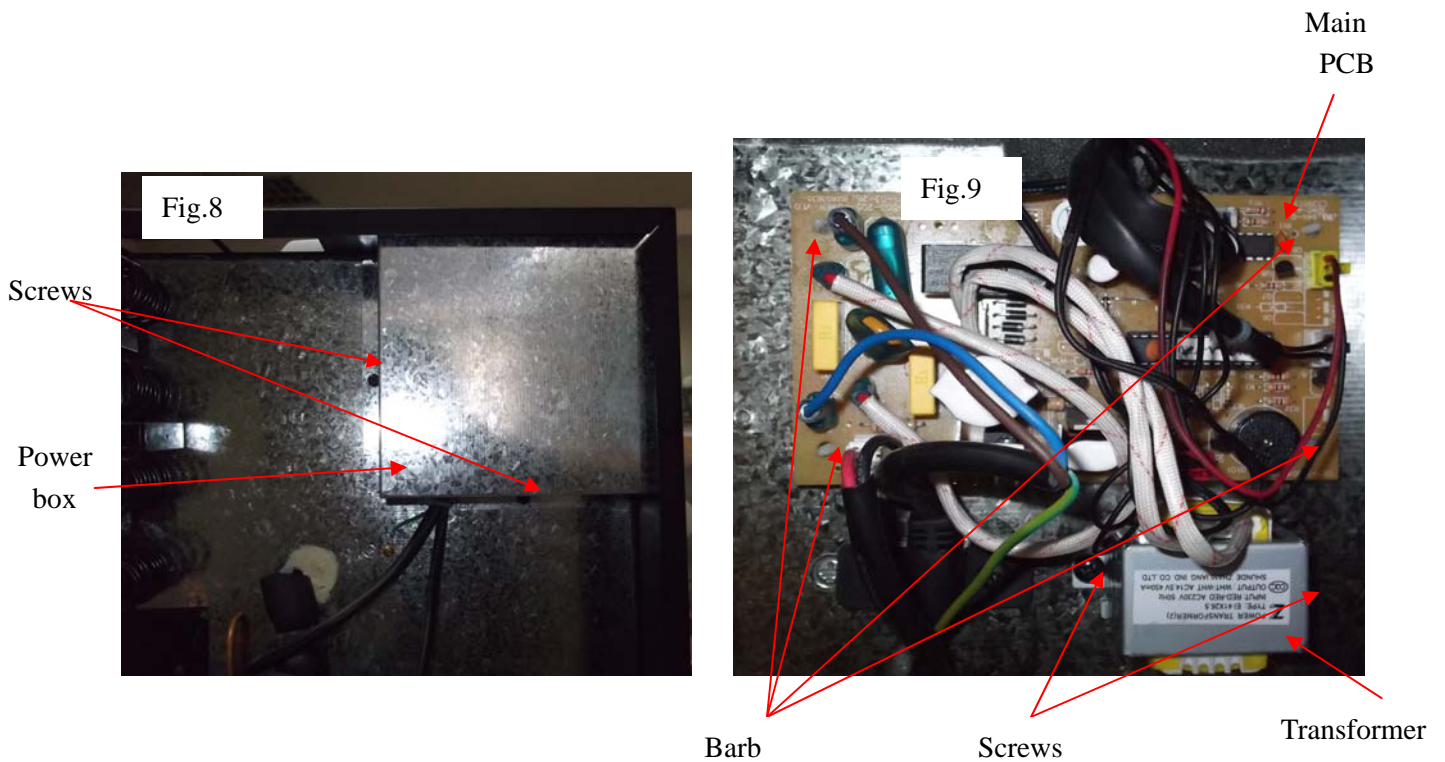

### 6.2.2 . How to remove the power PCB.

The process of removing the power PCB: Remove the power box → disconnect the connectors → remove the power PCB.

Disconnect all connectors, then press the barb one by one pull the PCB upward, remove the power PCB. (Notice: It is better to press the barbs by using the cusplate plier). ( Fig.10)

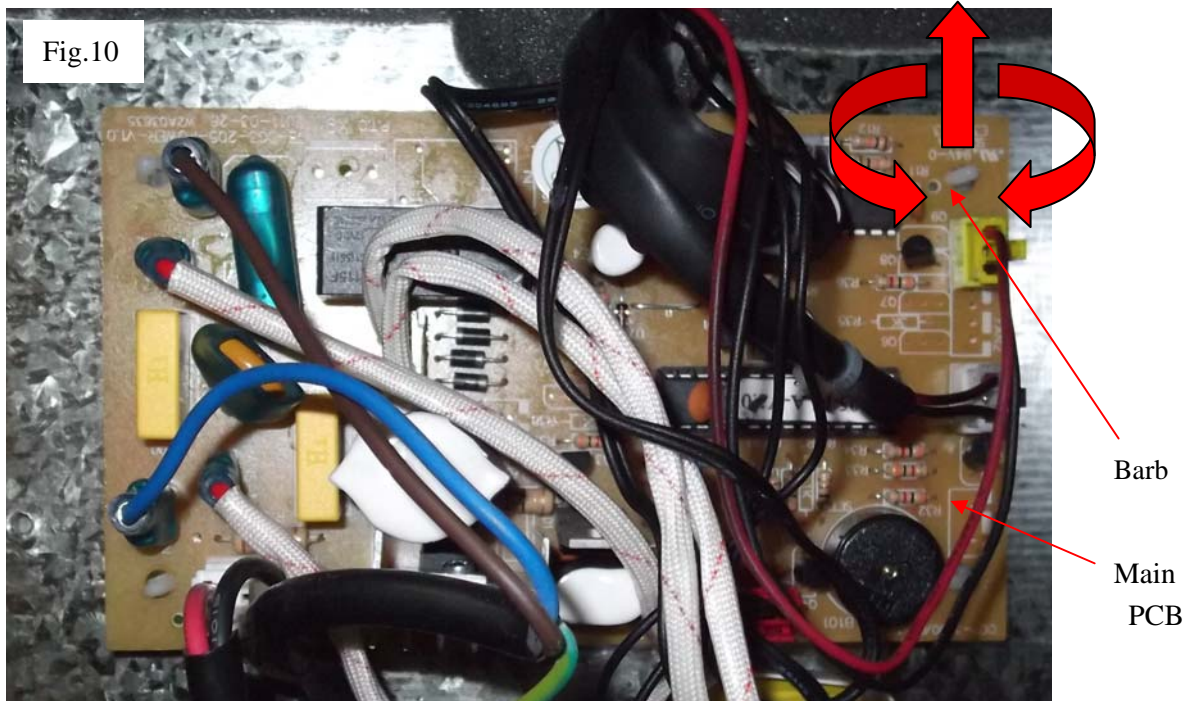

Diagram of main PCB connection ( Fig.11)

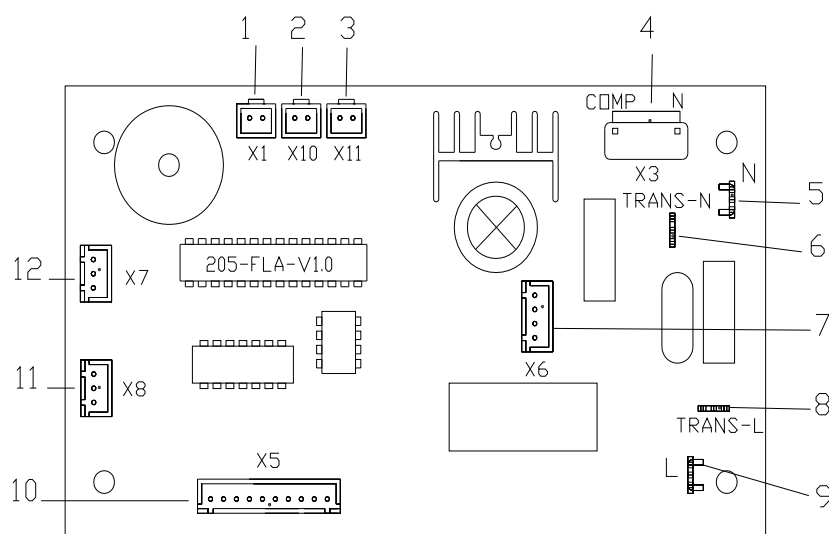

Fig.11

- |                            |                            |                          |                        |
|----------------------------|----------------------------|--------------------------|------------------------|
| 1. Anti-frost sensor (red) | 2. Inner sensor (white)    | 3. Door switch           | 4. Compressor          |
| 5. Power - N               | 6. Transformer primary - N | 7. Transformer secondary |                        |
| 8. Transformer primary - L | 9. Power - L               | 10. Display              | 11. Inner fan (yellow) |
| 12. LED light              |                            |                          |                        |

### 6.2.3 . How to remove the compressor.

The process of removing the compressor: Separate the pipe connect to the compressor→ remove the electrical cover of compressor → disconnect the connectors →remove the compressor

Heat the joints C,D, and disconnect the pipe by using plier, remove the electrical box of the compressor, disconnect the connecting wiring, then remove the four basic screws fixing compressor, remove the compressor.(Fig.12)

Diagram of soldering joints rear (Fig.12)

A: Jointing pipe and inner condenser pipe joint    B: Process pipe joint    C: Discharge pipe joint  
D: Suction pipe joint    E: Condenser pipe and filter joint    F: Capillary joint  
G: Condenser and inner condenser pipe joint    H: Condenser

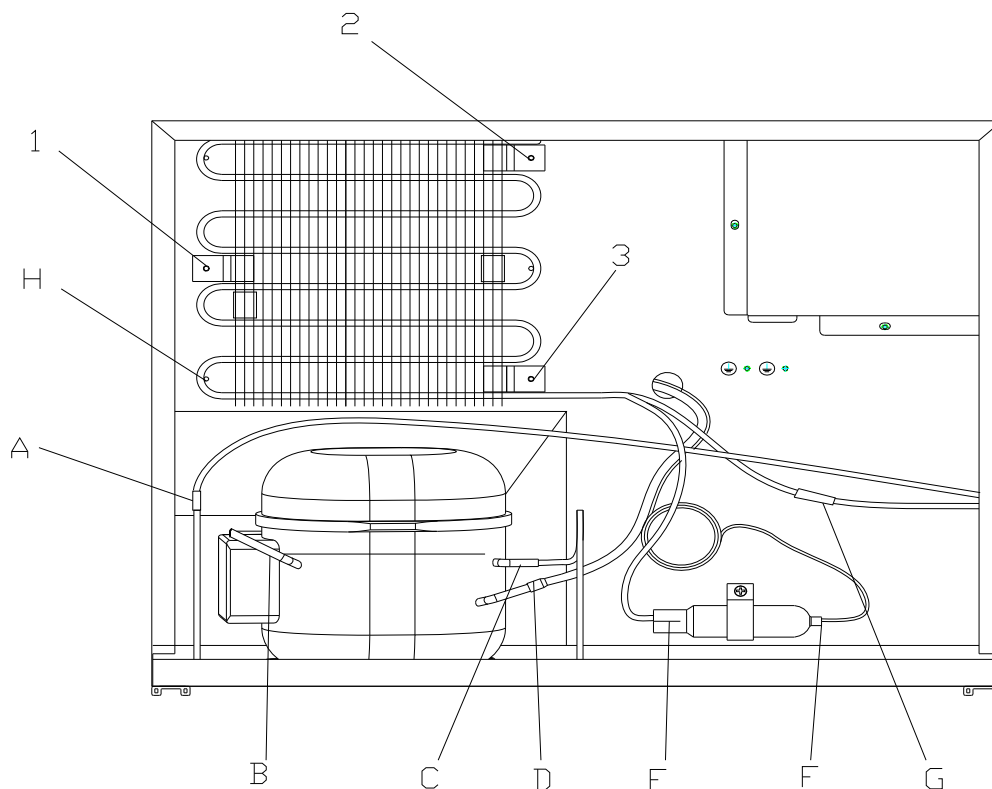

Fig.12

### 6.2.4 . How to remove the condenser.

The process of removing condenser: Remove the screws fixing condenser → remove the condenser.

Heat the F, G ( Fig.12 ), and disconnect the pipe from the joints by using the plier, remove the screws (1,2,3), take apart the condenser H. (Fig.12)

## 7. How to maintain the default.

It should take approximate 3 hours to reach the lowest setting temperature of about 5°C for an empty unit (assuming ambient temp of 32 degrees centigrade and continuous operation). If not, check the compressor, cooling fans, controller, and sensors. If all these are working normally, there is probably a cooling pipe fault.

### 7.1. Check the compressor

If the wine cooler not cooling, check the current with the Amp meter , refer to rating label, if it too high or too low, cut the discharge pipe (Fig.12 item C) and (Fig.12 item B), power on, check the current, and feel the discharge pipe, if the obvious air pressure from compressor, if the current still very high or very low or the discharge pipe with small air pressure, the compressor fault, replace the compressor please.

### 7.2. Check the cooling system

When it is sure that the compressor is working normally and the cooling system's fault is concentrating on the cooling system pipe. Check following below:

1>.Cut off process pipe and check the refrigerant. If there is not enough refrigerant, the default of the refrigerant system should be caused by the leaking. If the refrigerant is sufficient., it is probably block in the capillary.

2>.If the default is concentrated on the cooling system, the checking procedure is as below.

a. Cut off the discharge pipe (See Fig.5 showing C) of the compressor, and infuse 0.8-1.5 MP nitrogen per process pipe, and put the hand close to the cut kerf. If there is a little gas leak from the terminal, it means normal, otherwise it is jammed.

b . Make sure the capillary is working normally. Then reconnect the discharge pipe, and infuse 0.8-1.5 MP nitrogen from process pipe, then test the leakage, check with soap water if the cooling system of the soldering point is damaged. Check from the soldering point around the

compressor(Fig.12), if it is OK, then check the soldering point of the evaporator(Fig.3 ), before check please remove the air-duct board, please see the remove method and procedure in (→6.1.2)

c. If all the soldering point in b is not leaking, there are two possibility, one is leakage in the inner condenser (or anti- dew pipe), another is the damage on the spare parts in the cooling system. If it is the inner damage, it can not be repaired, and if the damage on the spare parts, replace them.

### 7.3. Refill the refrigerant:

Make sure there is no leakage in the cooling system, infuse the refrigerant.

1>.Using the vacuum pump form a vacuum in the system, via the joints of the high/low-pressure pipe, the

low-pressure pipeline is on the process pipe of the compressor (Fig.12 showing B), high-pressure pipeline is on the process pipe of the filter. Apply the vacuum pump for approximately 20 minutes. Until the vacuum is lower than 100Pa. Then solder the process pipe of the filter. Keep the vacuum running while soldering this joint

2>. Fill Cooling system with refrigerant via the process pipe of the compressor (Fig.12 showing B).

(Regarding refrigerant quantity Please refer to the instruction at back label of wine cellar). Then solder the compressor process pipe after the system is charged with refrigerant.

### 7.4. Running test:

After the procedures above finish, turn the unit on. To verify the effectiveness of the repair, monitor the unit, the compressor should automatically stop within + or - 2.5 deg centigrade of the set temperature within approx 3 hours (assuming an ambient temperature of 32°Cand the unit is empty).

### 7.5. Noise problem

#### 1 Compressor noise

1>. The working of motor and piston motion will cause noise when compressor working. So if noise is steady and not exceeds 42 dB, it's normal. If noise is not steady or very high, it's compressor fault and it should be maintained or replaced. (→6.2.3)

2>. If compressor's shock absorption rubber is hardening or damaged, or fixing screw of

compressor is too tight or loose, it will cause noise. The settlement is to change new shock absorption rubber or adjust fixing screws. ( →6.2.3 )

## 2 Fan noise

1>. When the fans are running , the vanes are circumrotating rapidly and the air flows, which will cause steady and standard noise. The noise should not exceed 32dB and it is normal.

2>. If the noise is extremely high and abnormal, replace the default fan please. ( →6.1.4 )

## 7.6. Refrigerant jet noise

Default: There is continuous noise like a water spray from the capillary.

Reason: The end of the capillary is in the wrong position, or there are rough edges on the end of the capillary

Solution:

1>. Remove the evaporator ( →6.2.3 ) , heat the soldered joint of the capillary ( Fig.3 ) , then remove the capillary from the evaporator and smooth the end with an eraser. (Caution: do not allow any particles into capillary unit).

2>. Replace the capillary into the evaporator, then solder it back into the correct position (not exceeding 15mm in the evaporator) and pack the joint with anti vibration compound

3>. Recharge with refrigerant. ( →7.3 )

## 7.7. Capillary vibration noise

Default: high frequency impact noise in capillary Zone.

Caused by either reason below:

1>. The capillary being insert too deep into the evaporator, so when the refrigerant is Jetting, the end of vibrating capillary will hit the inside of the evaporator.

2>. Vibration from the capillary touching the inside of the cabinet or air duct board, then when refrigerant is jetting.

Solutions:

1>. Refer to ( →7.6 )

2>. If the capillary touch the inner cabinet and the air duct panel, adjust the position of the capillary and add the incabloc plastic.

## 7.8. Oil jammed noise

Fault: intermittent and deep jet noise coming from inside of the capillary.

Cause: Compressor oil flowing into the cooling system pipe work probably due to the capillary slightly out of alignment during transportation

Solution: Clean the cooling system pipe, vacuumize it and recharge with refrigerant see (→7.3)

### 7.9. Evaporator freezing.

Because the door seal is not air-proof, or the door is not closed well, cause much water fill in the cabinet, and the water got frozen when it encounter the cold air, sometimes the ice is too thick, and it will block the fan or broken the fan.

The solution:

1 >. Replace the door seal or close the door well. If the door seal is slightly not air-proof, it can be repaired by the heat dryer.

Aiming at the distortion of the seal with the heat dryer, and move up and down until it expand to the normal state. When it is cool, check it with the door closed, if there is any distortion, dry it again until it fix for the door. (Fig.13)

2 >. If the fan is broken, replace the fan.



Fig.13

### 7.10. Unstable temperatures inside the cabinet.

The unstable temperature is caused by the evaporator fans cease, and it can be check by the below method: When the compressor is running, the fan should be running, if the fan stop, check the whether is any fault in the fan or fan connection. If the fan is broken, replace it with the fan of the same model .

### 7.11. The digital display's fault.

This malfunction is caused by the display panel's default, replace with the same model's display panel. (→

6.1.6)(→6.2.2)

### 7.12 Sensor fault.

The process of removing the sensor: Remove the shelves →

- 1 > . After turning on the power, if the LED display shows the temperature is similar with the ambient temperature, it is normal, if abnormal, please remove the electrical box, check the sensor insert whether reliable (Fig.11). If the insert is reliable, it is the sensor's fault, remove the air-duct board and replace the sensor with the same module (Fig.1, Fig.2, Fig.3);
- 2 > . If the readout show E1, E2, it is the inner sensor open or short circuit default (Fig.2.1), check the circuit and repair it or replace the sensor. ( Fig.14 , Fig.14.1)
- 3 > . Remove the screws, loose the clamp ( Fig.14);
- 4 > . Cut the sensor, the rest wiring should be long enough to reconnect. ( Fig.14.1)

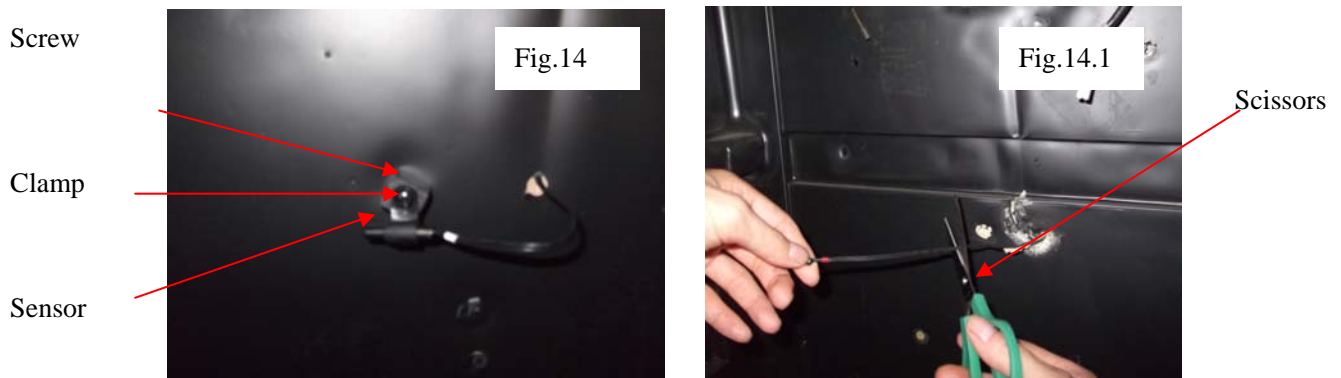

- 5>. Peel off the scarfskin about 12mm, cut the spare sensor and peel off it's scarfskin about 12 mm, connect the ends, and wrap the ends with insulating tape. Fix the sensor on the original position. (Fig.15& Fig.15.1)

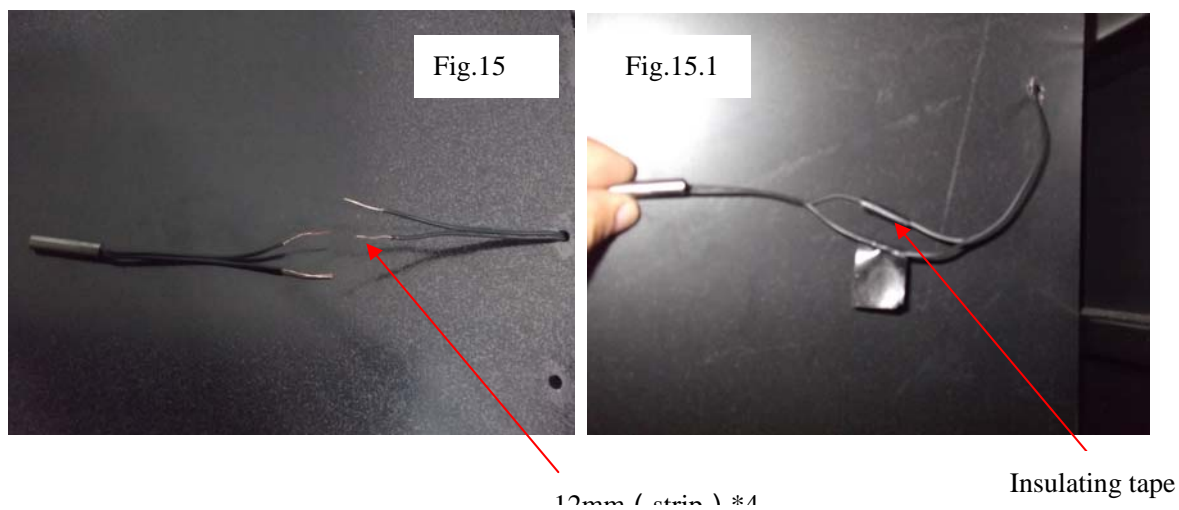

- 6 > . If the readout show E3, E4, it means the anti-frost sensor open or short circuit, the solution same as above.

## 7.12 Door switch fault.

- 1 > . Check it the X11 will connected ( Fig.11 ) , if it ok, replace the switch please.
- 2 > . Remove the switch box fixing screws, and cut the switch. ( Fig.16& Fig.16.1);
- 3 >. Peel off the scarfskin on the end about 12mm, cut the spare switch and peel off the scarfskin,

connect the ends and wrap the ends with insulating tape.

(Fig.17& Fig.17.1)

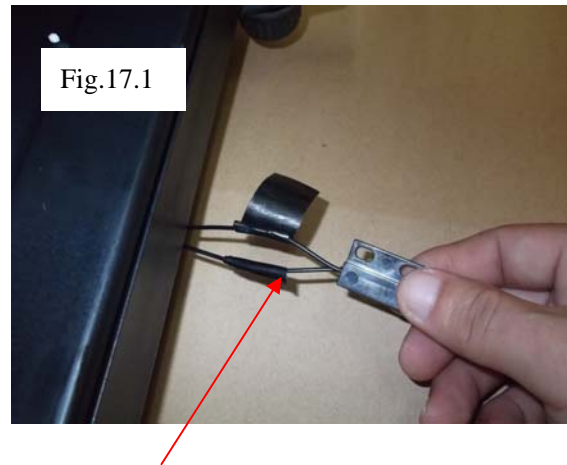
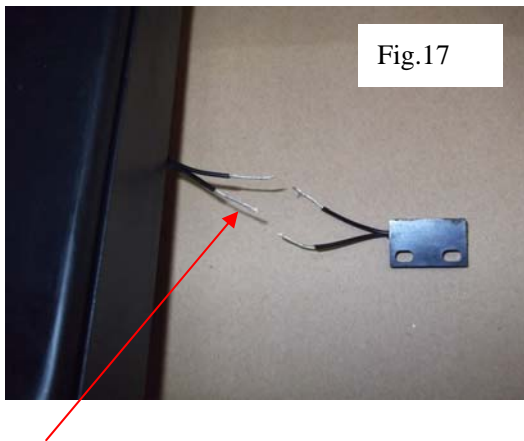
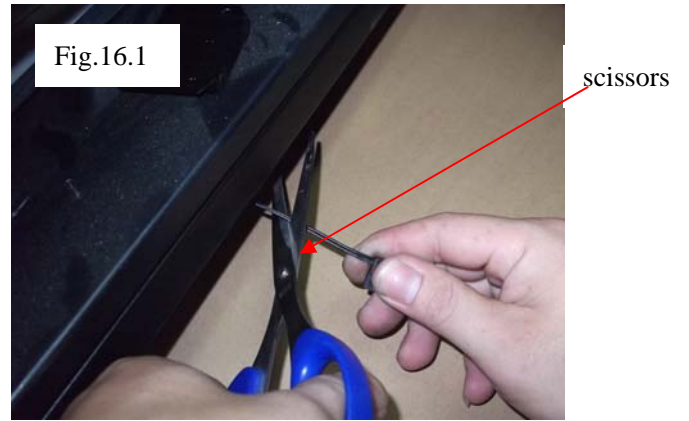
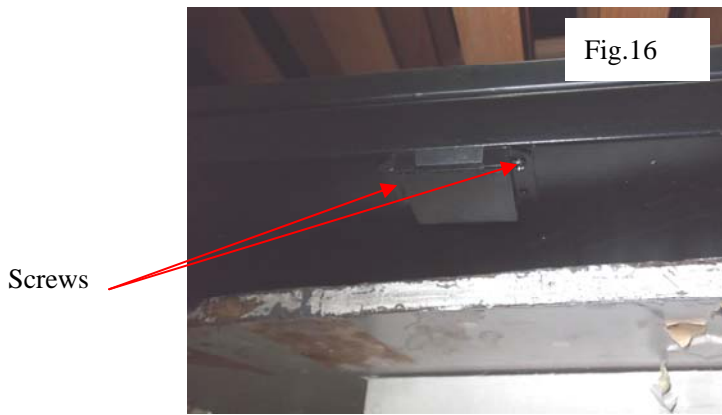

4 > . If above process finis, it still fault, that means the wiring damaged in the foam, you have to have another wiring along the bottom and back of the cabinet to connect the switch.

Rev:A ( LED VERSION )