



C601E/**

Caple 60cm Electric Hob
Brown, Black, Stainless Steel, White



INSTRUCTION MANUAL

Thank you for buying your new CAPLE Electric Hob. To ensure that you get the best results from your new Electric Hob, we strongly suggest that you read this instruction manual thoroughly before use. This manual contains installation advice, usage instructions and a cleaning guide, as well as other important facts about your CAPLE Electric Hob. If treated with care, your CAPLE Electric Hob should give you years of trouble-free cooking.

IMPORTANT WARNINGS AND ADVICE

After unpacking, make sure that the appliance is in perfect order. If you have any doubt, do not use it and contact the retailer or call a qualified engineer.

Pieces of packing (plastic bags, polystyrene, nails, metal, etc.) must not be left within the reach of children because they are potential sources of danger.

- Do not try to modify the appliance's technical characteristics because this could be dangerous
- Do not clean or maintain the appliance without previously disconnecting it
- Do not let children or people who are not capable use the appliance without supervision.

The manufacturer declines any responsibility for damage caused by incorrect, mistaken or irrational use.

THIS APPLIANCE COMPLIES WITH THE FOLLOWING DIRECTIVES:

EEC 73/23 and 93/88

(Low Voltage)

EEC 89/336

(Electromagnetic Compatibility)

EEC 89/109

(Contact with foods)

**For Spare Parts, Technical Advice
or Product Service call the
CAPLE HELPLINE on 0844 800 3830
(Answer phone outside office hours)**

TECHNICAL DATA

ELECTRIC HOTPLATES

145 mm dia. 1,0 kW - Normal hotplate
1,5 kW - Rapid hotplate

180 mm dia 1,5 kW - Normal hotplate
2,0 kW - Rapid hotplate

Cat: - see nameplate on cover; Class 3

Type "X" hobs

INSTALLATION

For the ELECTRIC WIRING DIAGRAM see figure 2 at the back of this manual. The electrical power is indicated on the nameplate underneath the hob. A copy of the nameplate is glued to the cover of this manual.

The appliance must be installed by qualified staff working in accordance with the regulations in force.

POSITIONING (fig. 3)

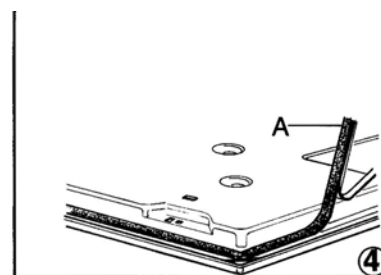
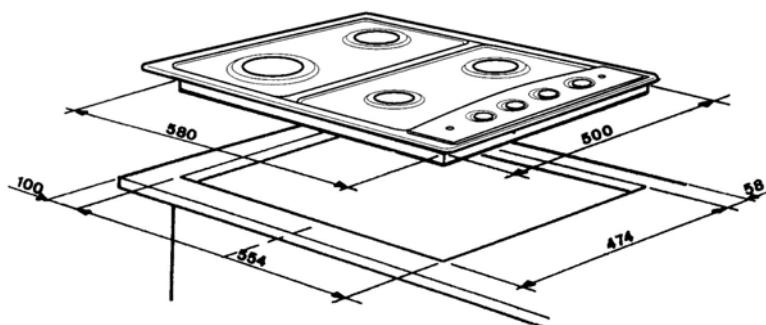

3

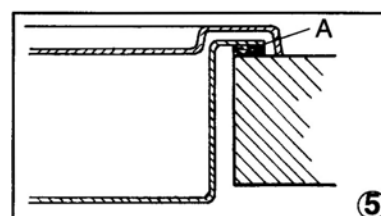

Free the hob from the packaging accessories, including the films covering the chrome plated or stainless steel parts. Place the hob well away from items of furniture taller than the hob for built-in installation. Any partition parallel to the hob must be at least 1 cm lower than the box unit in which it is installed, and a square opening with sides of 10 cm must be made under the gas hose elbow

FIXING

A self-adhesive seal (A) is supplied with the hob. This must be placed under the edge of the box unit, as close as possible to the edge itself (fig. 4). The seal must run all round the unit to ensure a perfect seal and prevent moisture from seeping under the hob.

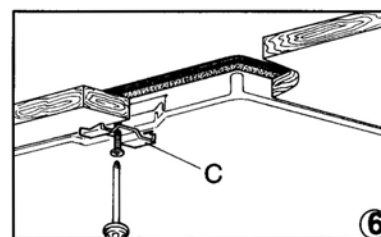

The hooks are secured directly to the box unit using the screws.

Place the hob in the hole in the work top, making sure that the adhesive ensures a good seal between the edge of the hob and the surface of the supporting unit (fig. 5) and conclude fixing by tightening the screws which secure the hooks (C) into their seats (fig. 6).

CONNECTING TO THE ELECTRICAL SUPPLY

Before making the connection, check that: -

The mains voltage is as indicated on the nameplate.

The earth connection is in good working order. If the socket is not easily accessible, the installation engineer must provide a switch with a contact-breaking gap of 3 mm or more. If the appliance power lead is not fitted with a plug, use an approved standard type, remembering that: -

- The green-yellow wire must be used for the earth connection;
- The blue wire is the neutral;
- The brown wire is live;
- The lead must never touch hot surfaces over about 75 degrees C;
- In case of replacement, the power lead must be of type H05RR-F or H05V2V2-F of adequate gauge (see fig.2) for gas and all-electric appliances, and type FR 3 R3 of adequate gauge (see fig.2) for gas/electric appliances;
- The power supply lead must only be replaced by a qualified electrician.

IMPORTANT: the manufacturer declines all liability for damage due to failure to comply with the regulations and standards in force. Check that the appliance is correctly connected to the earth (see diagrams in fig. 2).

ELECTRIC HOTPLATES

The different heat settings are obtained as follows: -

1 = minimum setting for all hotplates.

6 = maximum setting for normal and rapid hotplates (with red disc).

0 = off.

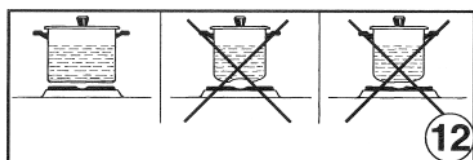

Pans must never be smaller in diameter than the hotplates and their bottoms must be as flat as possible (see fig. 12).

IMPORTANT

Never leave hotplates on without pans, except when first used; leave for about 10 minutes to dry oil or moisture residues;

- If the hotplate is to be out of use for a long time, apply a little grease to its painted surface.
- Do not allow spills to burn onto the hotplate, requiring the use of abrasive cleaners.

For economical cooking:

- Use pans with flat bottoms, which are in contact with the hotplate in all points.
- In stainless steel with thick or sandwich bottom.
- In aluminum with thick, flat bottom;
- In enameled steel.
- Make sure that pans are of appropriate size; the pan bottom diameter must be equal to or larger than that of the hotplate used.
- Switch the hotplate off a few minutes before the dish is completely cooked.
- Use a lid whenever possible to prevent losses by evaporation.
- Never supply more power than the food is able to absorb; excess heat leads to losses of water and fats and wasted energy.
- Never use more water than necessary.

The table below will serve as a guide, bearing in mind that cooking times and temperatures may vary depending on the type and amount of foods cooked and personal taste.

Knob setting	Heat intensity	Cooking process
0	OFF	-
1	WEAK	Keeping foods warm, béchamel sauce, custard
2	LOW	Reheating foods
3	MEDIUM	Pasta, vegetable soups, ragout
4	MEDIUM/HIGH	Boiling, roasting
5	HIGH	Steamed vegetables, steaks, fish
6	VERY HIGH	Grilling, omelettes, lamb chops

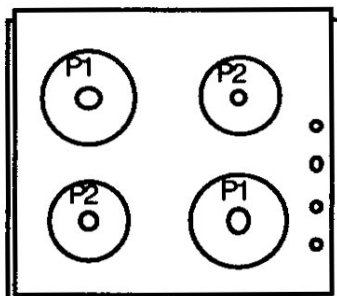

Hotplate P1 = Rapid 180mm dia.

Hotplate P2 = Semi Rapid 145mm dia.

ELECTRICAL CONNECTION DIAGRAMS

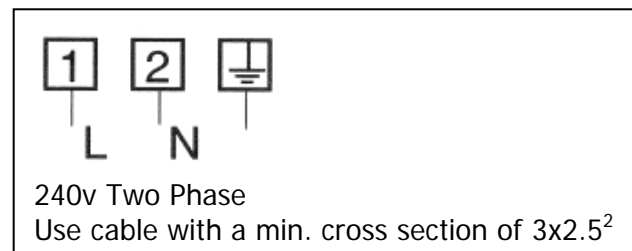
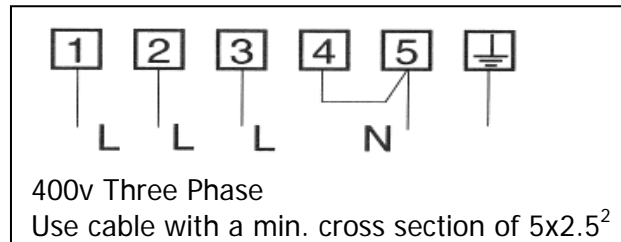
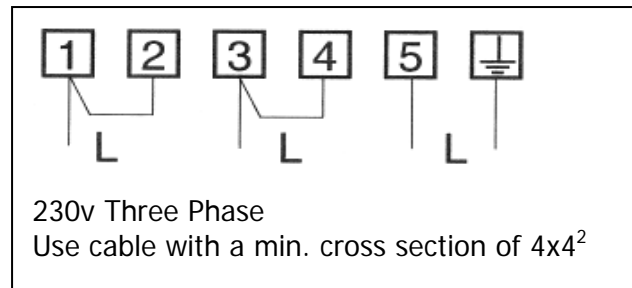
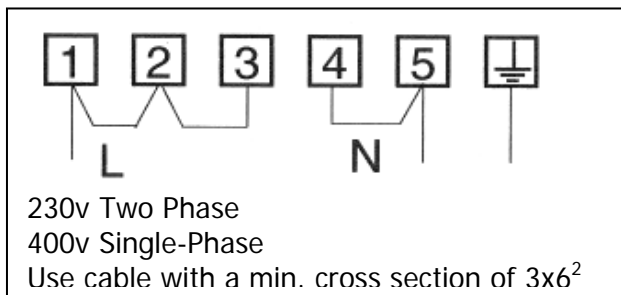

CAPLE "Built-in" Service

Should you require service at any time, please contact the **Caple Help line on 0844 800 3830**.

Caple have a nationwide service network of engineers who will respond quickly to your call.

Always replace spare parts with genuine Caple spares. These are available from authorised **Caple Service Centres** or by mail order from our **National Service Stores, simply telephone 0844 800 3830**. When ordering parts always quote the model number and serial number of your appliance.

YOUR GUARANTEE

CAPLE guarantees all parts of this product for one year from the date of purchase. During that time, should it become necessary CAPLE engineers will replace or repair all defective parts free of charge, except for parts subject to fair wear and tear, such as light bulbs.

Parts and the engineers labour costs are chargeable after the first 12 months.

To qualify for benefits under the guarantee, you must be able to provide proof of date of purchase and the appliance must have been supplied, installed and used for domestic purposes only in accordance with CAPLE instructions.

Consequential losses and accidental damage to the product are not covered by the guarantee.

This guarantee does not affect your statutory or common law rights.

CAPLE cannot be responsible for the results of using this appliance for any other purposes other than those described in these instructions.