



## Instruction manual for microwave oven and grill

Model code: CM112



Contact Caple on 0844 800 3830 or for spare parts [www.4caple.co.uk](http://www.4caple.co.uk)

## PRECAUTIONS TO AVOID POSSIBLE EXPOSURE TO EXCESSIVE MICROWAVE ENERGY

- (a) Do not attempt to operate this oven with the door open since this can result in harmful exposure to microwave energy. It is important not to break or tamper with the safety interlocks.
- (b) Do not place any object between the oven front face and the door or allow soil or cleaner residue to accumulate on sealing surfaces.
- (c) **WARNING:** If the door or door seals are damaged, the oven must not be operated until it has been repaired by a qualified person.

## ADDENDUM

If the apparatus is not maintained in a good state of cleanliness, its surface could be degraded and affect the lifespan of the apparatus.

## Specifications

Model:	CM112
Rated Voltage:	230V~50Hz
Rated Input Power(Microwave):	1150W
Rated Output Power(Microwave):	700W
Rated Input Power(Grill):	1000W
Oven Capacity:	17L
Turntable Diameter:	Ø 245mm
External Dimensions:	594x345x282mm
Net Weight:	Approx 14.0kg

# IMPORTANT SAFETY INSTRUCTIONS

## WARNING

To reduce the risk of fire, electric shock, injury to persons or exposure to excessive microwave oven energy when using your appliance, follow basic precautions, including the following:

1. Warning: Liquids and other foods must not be heated in sealed containers since they are liable to explode.
2. Warning: It is hazardous for anyone other than a competent person to remove a cover which gives protection against exposure to microwave energy.
3. Warning: Only allow children to use the oven without supervision when adequate instructions have been given so that the child is able to use the oven in a safe way and understand the hazards of improper use.
4. Warning: When the appliance is operated in the combination mode, children should only use the oven under adult supervision due to the temperatures generated. (only for grill series)
5. Only use utensils suitable for use in microwave ovens.
6. The oven should be cleaned regularly and any food deposits should be removed.
7. And follow the specific: "PRECAUTIONS TO AVOID POSSIBLE EXPOSURE TO EXCESSIVE MICROWAVE ENERGY".
8. When heating food in plastic or paper containers, keep an eye on the oven due to the possibility of ignition.
9. If smoke is observed, switch off or unplug the appliance and keep the door closed in order to stifle any flames.
10. Do not overcook food.
11. Do not use the oven cavity for storage purposes. Do not store items, such as bread, cookies, etc. inside the oven.
12. Remove wire twist-ties and metal handles from paper or plastic containers/bags before placing them in the oven.
13. Install or locate this oven only in accordance with the installation instructions provided.
14. Eggs in the shell and whole hard-boiled eggs should not be heated in microwave ovens since they may explode, even after microwave heating has ended.
15. Use this appliance only for its intended uses as described in manual. Do not use corrosive chemicals or vapors in this appliance. This oven is especially designed to heat. It is not designed for industrial or laboratory use.
16. If the supply cord is damaged, it must be replaced by the manufacturer, its service agent or similarly qualified persons in order to avoid a hazard.
17. Do not store or use this appliance outdoors.
18. Do not use this oven near water, in a wet basement or near a swimming pool.
19. The temperature of accessible surfaces may be high when the appliance is operating. The surfaces are liable to get hot during use. Keep cord away from heated surface, and do not cover any vents on the oven.
20. Do not let cord hang over edge of table or counter.
21. Failure to maintain the oven in a clean condition could lead to deterioration of the surface that could adversely affect the life of the appliance and possibly result in a hazardous situation.
22. The contents of feeding bottles and baby food jars shall be stirred or shaken and the temperature checked before consumption, in order to avoid burns.

23. Microwave heating of beverages can result in delayed eruptive boiling, therefore take care when handling the container.
24. The appliance is not intended for use by persons (including children) with reduced physical, sensory or mental capabilities, or lack of experience and knowledge, unless they have been given supervision or instruction concerning use of the appliance by a person responsible for their safety.
25. Children should be supervised to ensure that they do not play with the appliance.
26. The microwave oven shall not be placed in a cabinet unless it has been tested in a cabinet.
27. The appliances are not intended to be operated by means of an external timer or separate remote-control system.
28. **WARNING:** Ensure that the appliance is switched off before replacing the lamp to avoid the possibility of electric shock.
29. Accessible parts may become hot during use. Young children should be kept away from the steam cleaner is not to be used.
30. Surface of a storage drawer can get hot.
31. Do not use harsh abrasive cleaners or sharp metal scrapers to clean the oven door glass since they can scratch the surface, which may result in shattering of the glass.
32. During use the appliance becomes hot. Care should be taken to avoid touching heating elements inside the oven.
33. Only use the temperature probe recommended for this oven. (for ovens provided with a facility to use a temperature-sensing probe.)
34. The rear surface of appliance shall be placed against a wall.

# To Reduce the Risk of Injury to Persons

## Grounding Installation

### DANGER

#### Electric Shock Hazard

Touching some of the internal components can cause serious personal injury or death. Do not disassemble this appliance.

### WARNING

#### Electric Shock Hazard

Improper use of the grounding can result in electric shock. Do not plug into an outlet until appliance is properly installed and grounded.

This appliance must be grounded. In the event of an electrical short circuit, grounding reduces the risk of electric shock by providing an escape wire for the electric current. This appliance is equipped with a cord having a grounding wire with a grounding plug. The plug must be plugged into an outlet that is properly installed and grounded.

Consult a qualified electrician or serviceman if the grounding instructions are not completely understood or if doubt exists as to whether the appliance is properly grounded. If it is necessary to use an extension cord, use only a 3-wire extension cord.

### CLEANING

Be sure to unplug the appliance from the power supply.

1. Clean the inside of the oven after using with a slightly damp cloth.
2. Clean the accessories in the usual way in soapy water.
3. The door frame and seal and neighbouring parts must be cleaned carefully with a damp cloth when they are dirty.

1. A short power-supply cord is provided to reduce the risks resulting from becoming entangled in or tripping over a longer cord.
2. If a long cord set or extension cord is used:
  - 1)The marked electrical rating of the cord set or extension cord should be at least as great as the electrical rating of the appliance.
  - 2)The extension cord must be a grounding-type 3-wire cord.
  - 3)The long cord should be arranged so that it will not drape over the counter top or tabletop where it can be pulled on by children or tripped over unintentionally.

Three pin plug

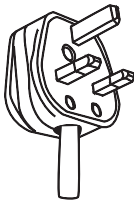

# UTENSILS

## CAUTION

### Personal Injury Hazard

It is hazardous for anyone other than a competent person to carry out any service or repair operation that involves the removal of a cover which gives protection against exposure to microwave energy.

See the instructions on "Materials you can use in microwave oven or to be avoided in microwave oven."

There may be certain non-metallic utensils that are not safe to use for microwaving. If in doubt, you can test the utensil in question following the procedure below.

### Utensil Test:

1. Fill a microwave-safe container with 1 cup of cold water (250ml) along with the utensil in question.
2. Cook on maximum power for 1 minute.
3. Carefully feel the utensil. If the empty utensil is warm, do not use it for microwave cooking.
4. Do not exceed 1 minute cooking time.

## Materials you can use in microwave oven

Utensils	Remarks
Aluminum foil	Shielding only. Small smooth pieces can be used to cover thin parts of meat or poultry to prevent overcooking. Arcing can occur if foil is too close to oven walls. The foil should be at least 1 inch (2.5cm) away from oven walls.
Browning dish	Follow manufacturer's instructions. The bottom of browning dish must be at least 3/16 inch (5mm) above the turntable. Incorrect usage may cause the turntable to break.
Dinnerware	Microwave-safe only. Follow manufacturer's instructions. Do not use cracked or chipped dishes.
Glass jars	Always remove lid. Use only to heat food until just warm. Most glass jars are not heat resistant and may break.
Glassware	Heat-resistant oven glassware only. Make sure there is no metallic trim. Do not use cracked or chipped dishes.
Oven cooking bags	Follow manufacturer's instructions. Do not close with metal tie. Make slits to allow steam to escape.
Paper plates and cups	Use for short-term cooking/warming only. Do not leave oven unattended while cooking.
Paper towels	Use to cover food for reheating and absorbing fat. Use with supervision for a short-term cooking only.
Parchment paper	Use as a cover to prevent splattering or a wrap for steaming.
Plastic	Microwave-safe only. Follow the manufacturer's instructions. Should be labeled "Microwave Safe". Some plastic containers soften, as the food inside gets hot. "Boiling bags" and tightly closed plastic bags should be slit, pierced or vented as directed by package.
Plastic wrap	Microwave-safe only. Use to cover food during cooking to retain moisture. Do not allow plastic wrap to touch food.
Thermometers	Microwave-safe only (meat and candy thermometers).
Wax paper	Use as a cover to prevent splattering and retain moisture.

## Materials to be avoided in microwave oven

Utensils	Remarks
Aluminum tray	May cause arcing. Transfer food into microwave-safe dish.
Food carton with metal handle	May cause arcing. Transfer food into microwave-safe dish.
Metal or metal-trimmed utensils	Metal shields the food from microwave energy. Metal trim may cause arcing.
Metal twist ties	May cause arcing and could cause a fire in the oven.
Paper bags	May cause a fire in the oven.
Plastic foam	Plastic foam may melt or contaminate the liquid inside when exposed to high temperature.
Wood	Wood will dry out when used in the microwave oven and may split or crack.

## SETTING UP YOUR OVEN

### Names of Oven Parts and Accessories

Remove the oven and all materials from the carton and oven cavity.

Your oven comes with the following accessories:

Glass tray	1
Turntable ring assembly	1
Instruction Manual	1

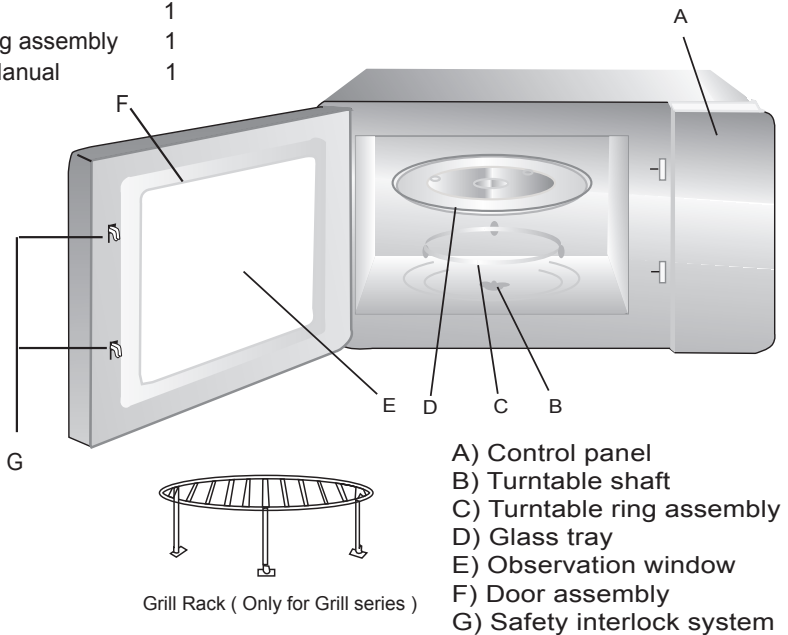

## Turntable Installation

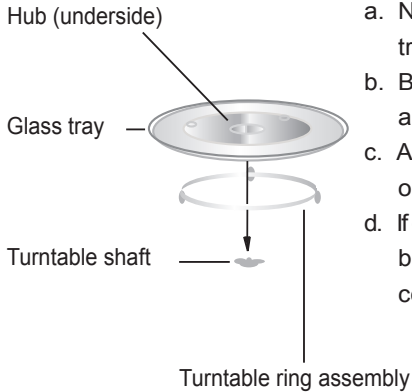

- a. Never place the glass tray upside down. The glass tray should never be restricted.
- b. Both glass tray and turntable ring assembly must always be used during cooking.
- c. All food and containers of food are always placed on the glass tray for cooking.
- d. If glass tray or turntable ring assembly cracks or breaks, contact your nearest authorised service centre.

## Installation and connection

1. This appliance is only intended for domestic use.
2. This oven is intended for built-in use only. It is not intended for counter-top use or for use inside a cupboard.
3. Please observe the special installation instructions.
4. The appliance can be installed in a 60cm wide wall-mounted cupboard (at least 55cm deep and 85cm off the floor).
5. The appliance is fitted with a plug and must only be connected to a properly installed earthed socket.
6. The mains voltage must correspond to the voltage specified on the rating plate.
7. The socket must be installed and connecting cable must only be replaced by a qualified electrician. If the plug is no longer accessible following installation, an all-pole disconnecting device must be present on the installation side with a contact gap of at least 3mm.
8. Adapters, multi-way strips and extension leads must not be used. Overloading can result in a risk of fire.

The accessible surface  
may be hot during  
operation.



# Operation Instructions

## 1. Clock Setting

When the microwave oven is on, the oven will display "0:00", buzzer will rings once.

- 1) Press "**Clock/ Pre-Set**", the hour figures will flash, and the indicator for clock " " will light.



- 2) Turn " " to adjust the hour figures, the input time should be within 0--23.



- 3) Press "**Clock/ Pre-Set**", the minute figures will flash.





- 4) Turn " " to adjust the minute figures, the input time should be within 0--59.



- 5) Press "**Clock/ Pre-Set**" to finish clock setting. The indicator for clock " " will go out, ":" will flash, and the time will light.



## 2. Cooking food

Press "**Micro./Grill/Combi.**" and turn " " to select the function you want. Press "**Micro./Grill/Combi.**" and turn " " to select the cooking time. Press "**Quick Start/Start**" to start cooking.

Example: If you want to use 80% microwave to cook food for 20 minutes, you can operate the oven as the following steps.

- 1) Press "**Micro./Grill/Combi.**", the screen display "P100".



- 2) Turn " " to adjust 80% microwave power until the oven displays "P 80".



- 3) Press "**Micro./Grill/Combi.**" to confirm, the screen displays "P 80".



- 4) Turn " " to adjust the cooking time until the oven displays "20:00".











- 5) Press "**Quick Start/Start**" to start cooking or press "**Cancel/Stop**" to cancel the settings.

Note: the step quantities for the adjustment time of the coding switch are as follow:

- 0--1 min : 5 seconds
- 1--5 min : 10 seconds
- 5--10 min : 30 seconds
- 10--30 min : 1 minute
- 30--95 min : 5 minutes



## "Micro./Grill/Combi." Pad instructions

Order	LED Display	Microwave Power	Grill Power
1		100%	
2		80%	
3		50%	
4		30%	
5		10%	
6		0%	100%
7		55%	45%
8		36%	64%

### 3. Program set in Advance

- 1) Set the clock first. (Consult the instruction of clock setting.)
- 2) Input the cooking program. Three stage power levels can be set at most. Defrost should always be set as the first stage, if it is included in the multi-level program.

Example: If you want to use 80% microwave to cook food for 15minutes, you can operate the oven as the following steps.

- a. Press "**Micro./Grill/Combi.**", the screen display "P100".
- b. Turn "", to adjust 80% microwave power until the oven displays "P 80".
- c. Press "**Micro./Grill/Combi.**" to confirm, the screen displays "P 80".
- d. Turn "", to adjust the cooking time until the oven displays "15:00".
- e. Be careful! Please do not press "**Quick Start/Start**" to start cooking.

- 3) Press "**Clock/ Pre-Set**", the hour figures will flash, and the indicator " " will light.

- 4) Turn "", to adjust the hour figures, the input time should be within 0--23.





5) Press " **Clock/ Pre-Set** ", the minute figures will flash.





6) Turn "  " to adjust the minute figures, the input time should be within 0--59.



7) Press " **Quick Start/Start** " to finish setting. The indicator for clock "  " will flash. If the door is closed, buzzer will ring twice when the time arrives, then cooking will start automatically and the indicator for clock "  " will go out.

#### 4. Defrost By W.T.

1) Press " **Defrost By W.T.** " button. LED will display "dEF1", "  " and "  " will light.



2) Turn "  " to select the weight of food. The weight is from 100 to 2000g.



3) Press " **Quick Start/Start** " to start defrosting food. "  " and "  " will flash.

#### 5. Defrost By Time

1) Press " **Defrost By Time** " button. LED will display "dEF2", "  " and "  " will light.



2) Turn "  " to select the cooking time. The MAX.time is 95 minutes.



3) Press " **Quick Start/Start** " to start defrosting food. "  " and "  " will flash.

#### 6. Multi-section cooking

At most 3 sections can be input for cooking. In multi-section cooking, if one section is defrosting, then defrosting shall be placed in the first section.

Example: If you want to use "20 minutes of 100% microwave power + 5 minutes of 80% microwave power " to cook food.

1) Press " **Micro./Grill/Combi.** " pad , the screen display "P100".



2) Press " **Micro./Grill/Combi.** " to select 100% microwave power.



3) Turn "  " to select cooking time.



4) Press " **Micro./Grill/Combi.** " pad , the screen display "P100".



5) Turn "" to select 80% microwave power.



6) Press "**Micro./Grill/Combi**" pad, then turn "" to select cooking time of 80% microwave power.



7) Press "**Quick Start/Start**" to start cooking or press "**Cancel/Stop**" to cancel the setting.

## 7. Start/Quick Start

When the oven is in the standby, Press "**Quick Start/Start**" to start cooking food with full microwave power for 1 minute. Each press will increase one minute. The maximum cooking time is 95 minutes.

## 8. Auto Menu

Example: If you want to use "Auto Menu" to cook fish of 250g.

1) Press "**Auto Menu**", "" and "**AUTO COOK**" will light.



2) Turn "" to select the function you want.



3) Press "**Auto Menu**" button to confirm.



4) Turn "" to select the weight of fish. "g" will light.



5) Press "**Quick Start/Start**" to start. "g" will go out, "" and "**AUTO COOK**" will flash.

## 9. Lock-out Function for Children

Lock: In standby, press "**Cancel/Stop**" for 3 seconds, there will be a long beep denoting entering the children-lock state and oven will display "".

Lock off: In locked state, press "**Cancel/Stop**" for 3 seconds, there will be a long "beep" denoting that the lock is released.

## 10. Inquiring Function

(1) In microwave, grill or combination cooking state, press "**Micro./Grill/Combi**", the current power will be displayed for 4 seconds. After 4 seconds, the oven will turn back to the former state;

(2) In cooking state, press "**Clock/ Pre-Set**" to inquire the present time and the time will flash for 4 seconds.

(3) In preset state, press "**Clock/ Pre-Set**" to inquire the preset time and it will flash for 4 seconds.

The automatic menu procedure:

Menu	Order	Weight	Display
A-1 Auto Reheat	1	200 g	2.00
		400 g	4.00
		600 g	6.00
A-2 Vegetable	2	200 g	2.00
		300 g	3.00
		400 g	4.00
A-3 Fish	3	250 g	2.50
		350 g	3.50
		450 g	4.50
A-4 Meat	4	250 g	2.50
		350 g	3.50
		450 g	4.50
A-5 Pasta	5	50 g	0.50
		100 g	1.00
A-6 Potato	6	200 g	2.00
		400 g	4.00
		600 g	6.00
A-7 Pizza	7	200 g	2.00
		400 g	4.00
A-8 Soup	8	200 ml	2.00
		400 ml	4.00

## Trouble shooting

<b>Normal</b>	
Microwave oven interfering TV reception	Radio and TV reception may be interfered when microwave oven operating. It is similar to the interference of small electrical appliances, like mixer, vacuum cleaner, and electric fan.
Dim oven light	In low power microwave cooking, oven light may become dim.
Steam accumulating on door, hot air out of vents	In cooking, steam may come out of food. Most will get out from vents. But some may accumulate on a cool place like oven door. It is normal.
Oven started accidentally with no food in.	It is forbidden to run the unit without any food inside. It is very dangerous.



<b>Trouble</b>	<b>Possible Cause</b>	<b>Remedy</b>
Oven can not be started.	(1) Power cord not plugged in tightly.	Unplug. Then plug again after 10 seconds.
	(2) Fuse blowing or circuit breaker works.	Replace fuse or reset circuit breaker (repaired by professional personnel of our company)
	(3) Trouble with outlet.	Test outlet with other electrical appliances.
Oven does not heat.	(4) Door not closed well.	Close door well.
Glass turntable makes noise when microwave oven operates	(5) Dirty roller rest and oven bottom.	Refer to "Maintenance of Microwave" to clean dirty parts.



According to Waste of Electrical and Electronic Equipment (WEEE) directive, WEEE should be separately collected and treated. If at any time in future you need to dispose of this product please do NOT dispose of this product with household waste. Please send this product to WEEE collecting points where available.

# Installation Instructions

Please Read the Manual Carefully Before Installation

- ADJUST SCREW A 
- SCREW B 
- TRIM-KIT PLASTIC COVER 

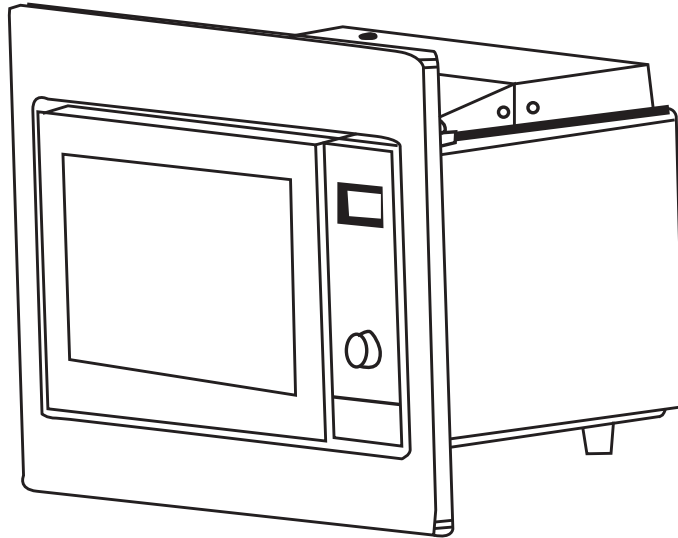

## Please Note

### Electrical connection

The oven is fitted with a plug and must be only connected to a properly installed earthed socket. In accordance with the appropriate regulations, the socket must only be installed and the connecting cable must only be replaced by a qualified electrician.

If the plug is no longer accessible following installation and all-pole isolating switch must be present on the installation side with a contact gap of at least 3mm.

## A. Built-in furniture

The built-in cabinet shall not have a rear wall behind the appliance.

Minimum installation height is 85cm.

Do not cover ventilation slots and air intake points.

1.

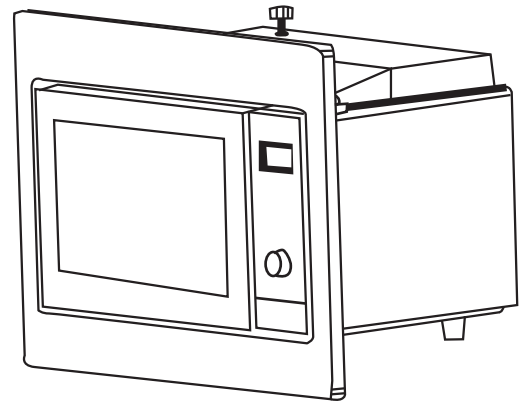
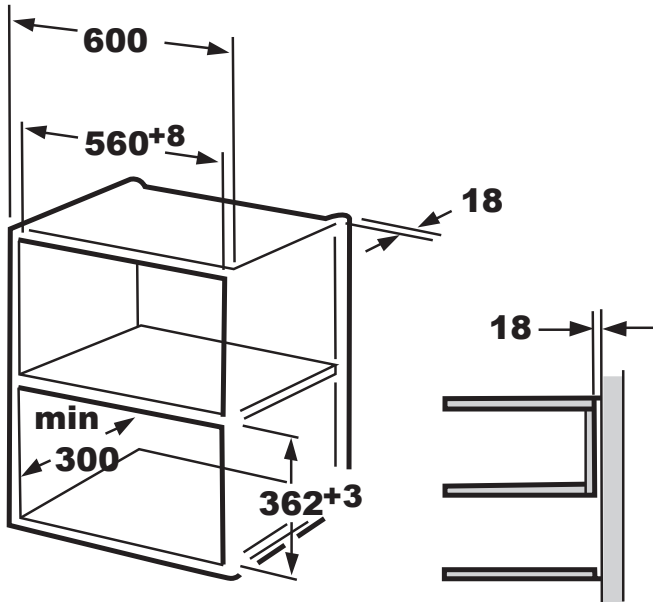

2.

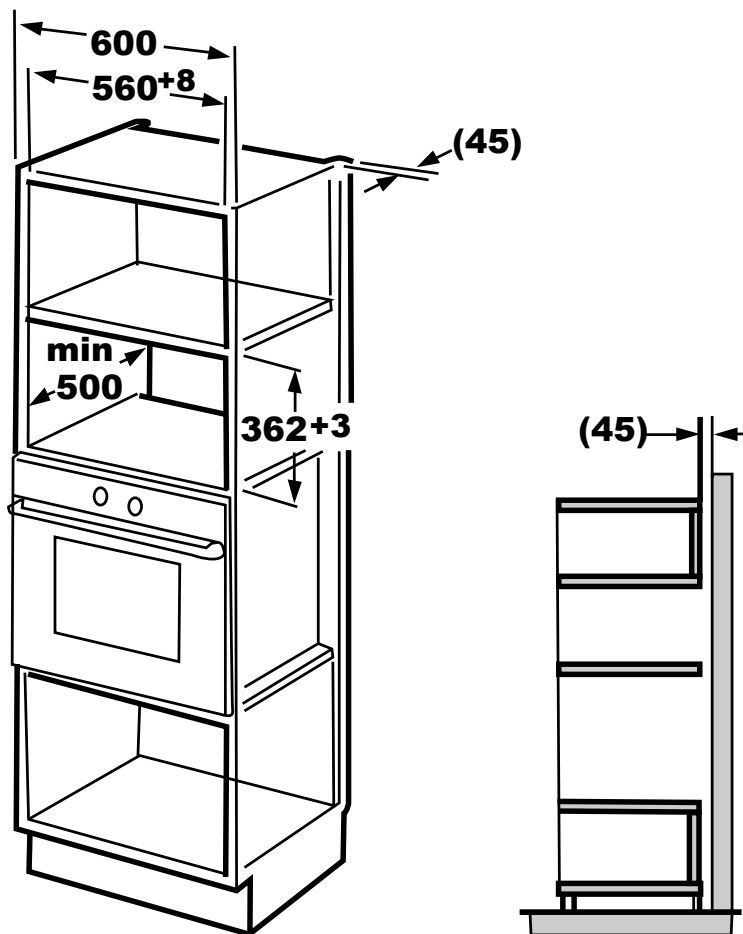

## B. Install the Oven

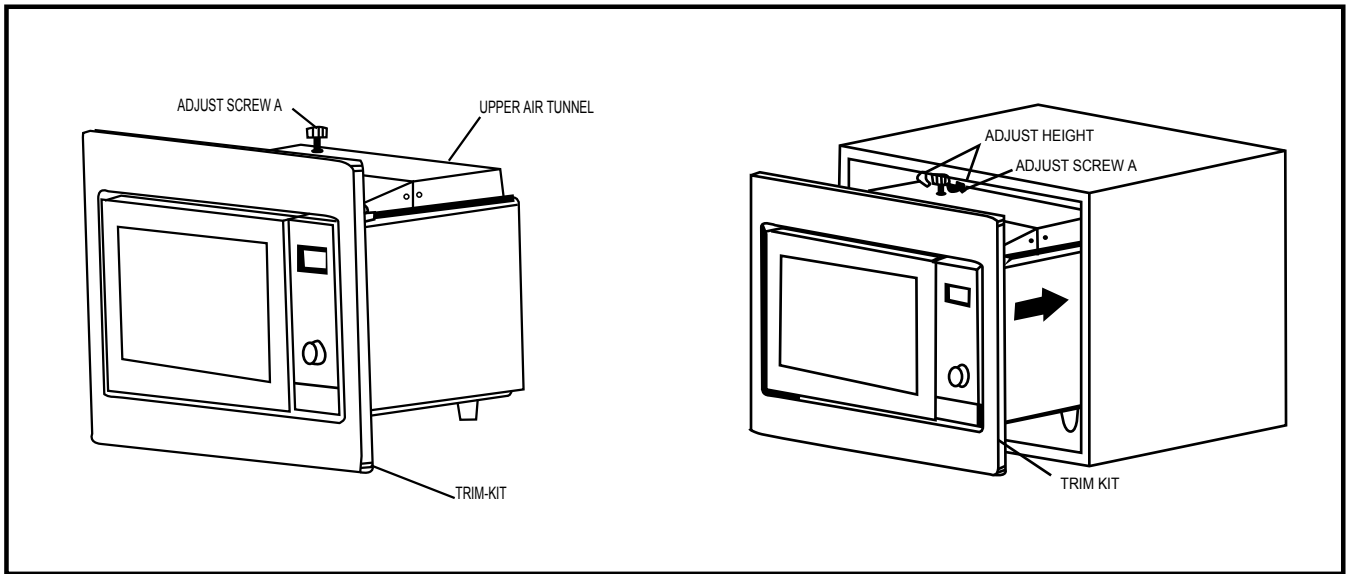

1. Fix ADJSUTSCREW A on the UPPER AIR TUNNEL of the oven, and then install the oven into the cabinet.

- Adjust the height of ADJUST SCREW A to keep 1mm gap between the ADJUST SCREW A and the top plane of cabinet.
- Do not trap or kink the power cord.
- Make sure that the oven is installed in the center of the cabinet.

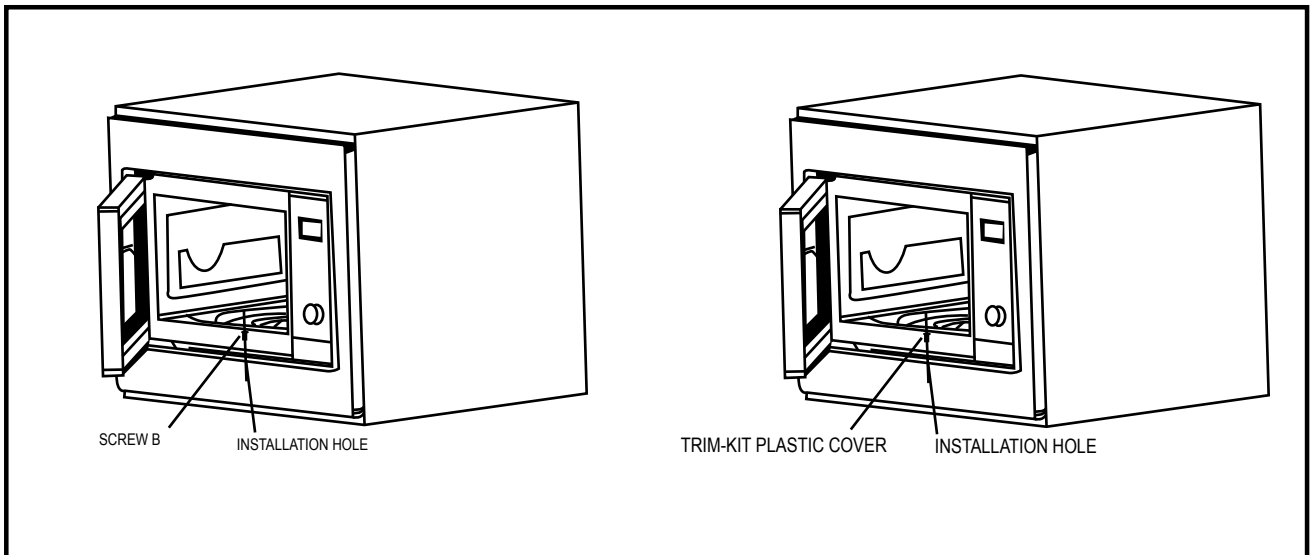

2. Open the door; fix the oven to the cabinet with SCREW B at the INSTALLATION HOLE of TRIM KIT. Then fix the TRIM-KIT PLASTIC COVER to the INSTALLATION HOLE.