

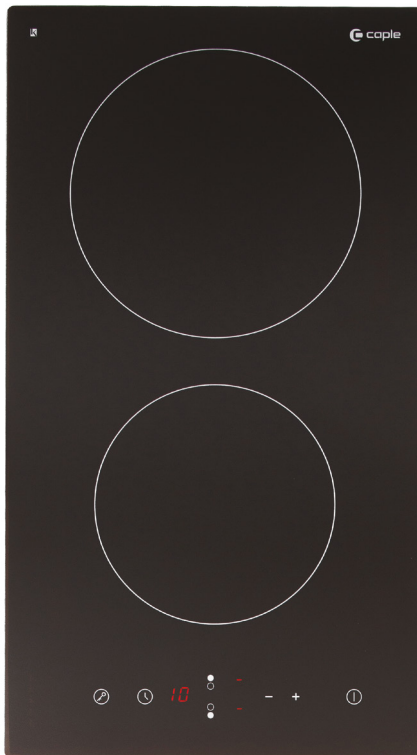

Ceramic Hob Instruction Manual

C892C



Contact Caple on 0117 938 7420 for spare parts or www.caple.co.uk

CONTENTS

Introduction	3
Safety Instructions	4
Environmental Protection	10
Warranty	10
Product Description	11
Control Panel	11
Using your Ceramic Hob	14
Cooking Guidelines	20
Cleaning and Maintenance	22
Troubleshooting	23
Installation	24
Technical Specification	30
Caple Contact Information	32

INTRODUCTION

Congratulations on the purchase of your new Caple ceramic hob.

We recommend that you take some time to read this instruction manual in order to fully understand how to correctly install and operate it. For installation, please read the installation section. Read all the safety instructions carefully before use and keep this instruction manual for future reference.

SAFETY INSTRUCTIONS

- Your safety is important to us. Please read this information before using your hob.

INSTALLATION

ELECTRICAL SHOCK HAZARD

- Disconnect the appliance from the mains electricity supply before carrying out any work or maintenance on it.
- Connection to a good earth wiring system is mandatory.
- Alterations to the domestic wiring system must only be made by a qualified electrician.
- Failure to follow this advice could be fatal or seriously injure the user.

CUT HAZARD

- If you choose to use a ceramic hob scraper, the razor blade is exposed when the safety cover is retracted. Use with extreme care and always store safely and out of reach of children.
- Failure to use caution could result in injury or cuts.
- Take care - panel edges are sharp. Failure to do so may result in injury or cuts.

IMPORTANT SAFETY INSTRUCTIONS

- Read these instructions carefully before installing or using this appliance.
- No combustible materials or products should be placed on this appliance at any time.

- Please make this information available to the person responsible for installing the appliance.
- In order to avoid a hazard, this appliance must be installed according to these instructions.
- This appliance is to be installed correctly and earthed only by a suitably qualified person.
- This appliance should be connected to a circuit which incorporates an isolating switch providing full disconnection from the power supply.
- Failure to install the appliance correctly could invalidate any warranty or liability claims.

OPERATION AND MAINTENANCE WARNINGS

ELECTRICAL SHOCK HAZARD

- Do not cook on a broken or cracked hob. If the hob surface should break or crack, switch the appliance off immediately at the main power supply (wall switch) and contact a qualified technician.
- Switch the hob off at the wall before cleaning or maintenance.
- Failure to follow this advice could be fatal or seriously injure user.

HOT SURFACE HAZARD

- During use, accessible parts of this appliance will become hot enough to cause burns.
- Do not let your body, clothing or any item other than suitable cookware contact the glass until the surface is cool.
- Metallic objects such as knives, forks, spoons and lids should not be placed on the hob surface.
- Beware: magnetisable metal objects worn on the body may become hot in the vicinity of the hob. Gold or silver jewellery will not be effected.
- Keep children away from appliance.
- Handles of saucepans may be hot to touch. Check saucepan handles do not overhang other cooking zones that are on. Keep handles out of reach of children.
- Failure to follow this advice could result in burns and scalds.

CUT HAZARD

- The razor sharp blade of a hob scraper is exposed when the safety cover is retracted. Use with extreme care and always store safely and out of reach of children
- Failure to use caution could result in serious injury or cuts.

IMPORTANT SAFETY INSTRUCTIONS

- Never leave the appliance unattended when in use as pans may boil over which may result in smoking or grease spills that may ignite.
- Never use your appliance as a work or storage surface.
- Never leave any objects or utensils on the appliance.
- Never use your appliance for warming or heating the room.

- After use, always turn off the cooking zones and the hob as described in this manual (i.e. by using the touch controls).
- Do not allow children to play, sit, stand, or climb on the appliance.
- Do not store childrens toys in cabinets above the appliance to avoid the risk of children climbing on the hob as this could result in serious injury.
- Do not leave children alone or unattended in the kitchen when the hob is in use.
- Persons with reduced physical, sensory or mental capabilities or lack of experience and knowledge must be supervised and given appropriate instruction concerning the use of the appliance in a safe way and understand the hazards involved.
- Do not repair or replace any part of the appliance unless specific instructions are detailed in the manual. All other servicing should be done by a qualified technician.
- Do not use a steam cleaner to clean the hob.
- Do not place or drop heavy objects on your hob.
- Do not stand on your hob.
- Do not use pans with jagged edges or drag pans across the surface as this can scratch the glass.
- Do not use scourers or any other harsh abrasive cleaning agents to clean your hob, as these can scratch glass.
- If the supply cord is damaged, it must be replaced by Caple service or similarly qualified persons in order to avoid a hazard.

- This product is not designed for commercial use, it is a household appliance only. It is not intended to be used in:
 - Staff kitchen areas in shops, offices and other working environments.
 - Bed and breakfast type environments
 - By clients in hotels, motels and other residential type environments.

WARNING:

- The appliance and its accessible parts become hot during use.
- Care should be taken to avoid touching heating elements.
- Children less than 8 years of age shall be kept away unless continuously supervised.
- This appliance can be used by children aged from 8 years and above and persons with reduced physical, sensory or mental capabilities or lack of experience and knowledge if they have been given supervision or instruction concerning use of the appliance in a safe way and understand the hazards involved.
- Children should not play with the appliance.
- Cleaning and user maintenance should not be carried out by children without supervision.
- Unattended cooking on a hob with fat or oil can be dangerous and may result in fire. NEVER try to extinguish a fire with water, but switch off the appliance and then cover flame e.g. with a lid or a fire blanket.
- Danger of fire: do not store items on the cooking surfaces.
- If the glass/ceramic surface is cracked it can expose live parts, switch off the appliance to avoid the possibility of electric shock.
- Do not steam clean.
- The appliance is not intended to be operated by means of an external timer or separate remote control system.



ENVIRONMENTAL PROTECTION

Waste electrical products should not be disposed of with household waste. Please recycle where facilities exist. Check with your Local Authority or retailer for recycling advice. This appliance is marked according to the European directive on Waste Electrical and Electronic Equipment (WEEE).

By ensuring this product is disposed of correctly, you will help prevent potential negative consequences for the environment and human health, which could otherwise be caused by inappropriate waste handling of this product. The symbol on the product indicates that this product may not be treated as household waste. Instead it shall be handed over to the applicable collection point for the recycling of electrical and electronic equipment. Disposal must be carried out in accordance with local environmental regulations for waste disposal.

For more detailed information about treatment, recovery and recycling of this product, please contact your local council, your household waste disposal service or the retailer where you purchased the product.

CE DECLARATIONS OF CONFORMITY



This appliance has been manufactured to the strictest standards and complies with all applicable legislation, Low Voltage Directive (LVD) and Electromagnetic Compatibility (EMC).

WARRANTY

Your new appliance is covered by warranty. The warranty card is enclosed - if it is missing, you must provide the following information to your retailer in order to receive a replacement: date of purchase, model and serial number. Registration can also be completed online by visiting www.caple.co.uk.

Ensure you keep your warranty card safe, you may need to show it to Caple Service together with proof of purchase.

If you fail to show your warranty card you will incur all repair charges. Spare parts are only available from Caple Service and spare parts authorised centres.

PRODUCT DESCRIPTION

TOP VIEW

- » Max. 1800 W zone
- » Max. 1200 W zone
- » Glass plate
- » ON / OFF
- » Control panel

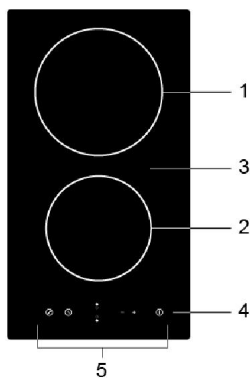

CONTROL PANEL

- » ON /OFF control
- » Power / Timer regulating controls
- » Heating zone selection controls
- » Timer control
- » Keylock control

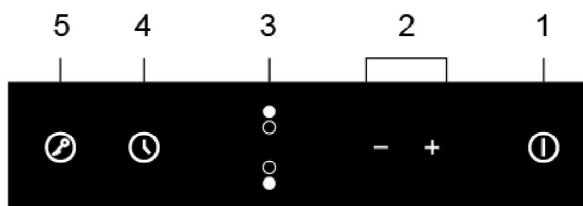

BEFORE USING YOUR NEW CERAMIC HOB

- » Read this guide, taking special note of the 'Safety Warnings' section.
- » Remove any protective film that may still be on your ceramic hob.

USING THE TOUCH CONTROLS

- » The controls respond to touch, so you don't need to apply any pressure.
- » Use the ball of your finger, not its tip.
- » You will hear a beep each time a touch is registered.
- » Make sure the controls are always clean, dry, and that there is no object (e.g. a utensil or a cloth) covering them. Even a thin film of water may make the controls difficult to operate.

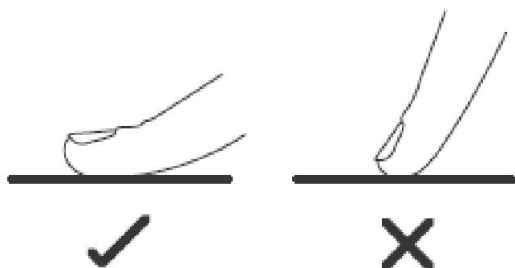

CHOOSING THE RIGHT COOKWARE

Do not use cookware with jagged edges or a curved base.



Make sure that the base of your pan is smooth, sits flat against the glass, and is the same size as the cooking zone. Always centre your pan on the cooking zone.

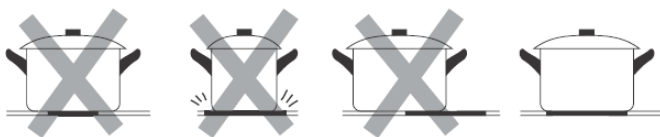



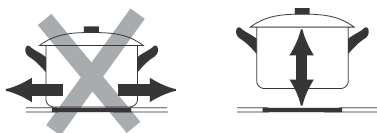

Always lift pans off the ceramic hob – do not slide, or they may scratch the glass.



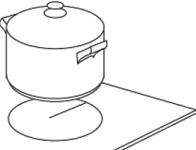

USING YOUR CERAMIC HOB

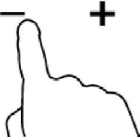
TO START COOKING

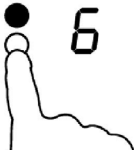
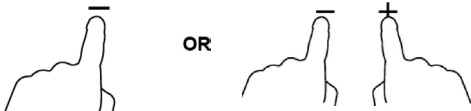

	<p>When the power to the hob is turned on, the buzzer sounds once, all the indicators light up for 1 second and then go out, indicating that the ceramic hob has entered standby mode.</p> <p>To turn on touch the ON/OFF control . All the indicators then show " — ".</p>
	<p>Place a suitable pan on the cooking zone that you wish to use.</p> <p>Make sure the bottom of the pan and the surface of the cooking zone are clean and dry.</p>
	<p>Touch the heating zone selection control.</p>
	<p>Select a heat setting by touching the " + " or " — " control.</p> <p>If you do not choose a heat setting within 1 minute, the ceramic hob will automatically switch off. You will need to start again at step 1.</p> <p>You can modify the heat setting at any time during cooking.</p>

WHEN YOU HAVE FINISHED COOKING

	<p>Touch the heating zone selection control that you wish to switch off.</p>
	<p>Turn the cooking zone off by scrolling down to "0" or touching the "-" and "+" control together.</p>
	<p>Turn the whole hob off by touching the ON/OFF ① control.</p>
	<p>Beware of hot surfaces</p> <p>"H" will show which cooking zone is hot to touch. It will disappear when the surface has cooled down to a safe temperature. It can also be used as an energy saving function if you want to heat further pans using the zone that is still hot.</p>

LOCKING THE CONTROLS

- » You can lock the controls to prevent unintended use (for example children accidentally turning the cooking zones on).
- » When the controls are locked, all the controls except the ON/OFF control are disabled.
- » In the event of a emergency you can always turn the hob off by pressing the ON/OFF  button.

TO LOCK THE CONTROLS	
	Touch the lock control, the timer will then display 'Lo'
TO UNLOCK THE CONTROLS	
	Make sure the hob is turned on. Touch and hold the keylock control  for 5 seconds.

OVER-TEMPERATURE PROTECTION

A temperature sensor equipped can monitor the temperature inside the ceramic hob. When an excessive temperature is monitored, the ceramic hob will stop operation automatically.

RESIDUAL HEAT WARNING

When the hob has been operating for some time, there will be some residual heat. The letter "H" appears to warn you to keep away from it.

AUTO SHUTDOWN

Another safety feature of the hob is auto shutdown. This occurs whenever you forget to switch off a cooking zone. The default shutdown times are shown in the table below:

POWER LEVEL	1	2	3	4	5	6	7	8	9
DEFAULT WORKING TIMER (HOUR)	8	8	8	4	4	4	2	2	2

USING THE TIMER

You can use the timer in two different ways:

- » You can use it as a minute minder. In this case, the timer will not turn any cooking zone off when the set time is up.
- » You can set it to turn one cooking zone off after the set time is up.
- » The timer maximum is 99 minutes.

USING THE TIMER AS A MINUTE MINDER

Make sure the hob is turned on and a heating zone is in use.

Touch the “-” or the “+” controls of the timer. The minute minder indicator will flash.

Set the time by touching the “-” or “+” controls. The minute minder indicator will start flashing and will show in the timer display.

Touch the “-” or “+” control of the timer once to decrease or increase the time by 1 minute.



Touch and hold the “-” or “+” control of the timer to decrease or increase by 10 minutes.

If the setting time exceeds 99 minutes, the timer will automatically return to 0 minute.

Touching the “-” and “+” together, the timer is cancelled and the “--” will show in the minute display.





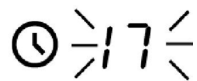

When the time is set, it will begin to count down immediately. The display will show the remaining time and the timer indicator will flash for 5 seconds.



A buzzer will sound for 30 seconds and the timer indicator will show “--” when the timer has finished.

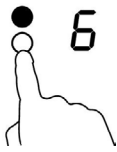
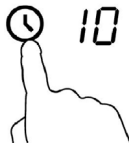

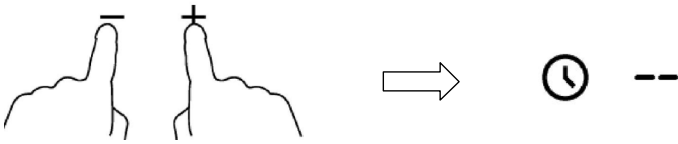
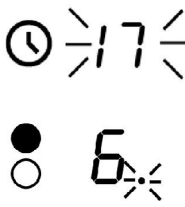
SETTING THE TIMER TO TURN ONE COOKING ZONE OFF

<p>Touch the heating zone selection control.</p>	
<p>Touch the timer control, the timer indicator will show '10'.</p>	
<p>Set the time by touching the control of the timer.</p> <p>Touching the "—" or "+" control of the timer once will decrease or increase by one minute.</p> <p>Touching and holding the "—" or "+" control of the timer will decrease or increase by 10 minutes.</p> <p>If the setting time exceeds 99 minutes, the timer will automatically return to 0 minute.</p>	
<p>Touching the "—" and "+" together, the timer is cancelled, and the display will show "--" in the minute display.</p> 	
<p>When the time is set, it will begin to count down immediately. The display will show the remaining time and the timer indicator will flash for 5 seconds.</p> <p>The red dot next to power level indicator will illuminate indicating that zone is selected.</p>	
<p>When cooking timer expires, the corresponding cooking zone will be switched off automatically.</p>	

SETTING THE TIMER TO TURN MORE THAN ONE COOKING ZONE OFF

If more than one heating zone uses this function, the timer indicator will show the lowest time. (e.g zone 1# setting time of 5 minutes, zone 2# setting time of 15 minutes, the timer indicator shows "5".)

NOTE: The red dot next to power level indicator will flash.

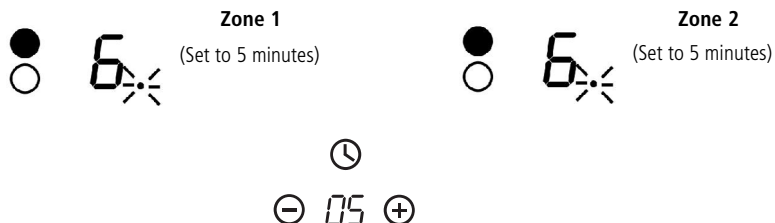

Once the countdown timer expires, the corresponding zone will switch off. Then it will show the new min. timer and the dot of the corresponding zone will flash.



When cooking timer expires, the corresponding cooking zone will switch off automatically.



NOTE: The red dot next to power level indicator will illuminate indicating that zone is selected.



If you want to change the time after the timer is set, you have to start from step 1.

COOKING GUIDELINES

Take care when frying as the oil and fat heat up very quickly, particularly if you're using PowerBoost. At extremely high temperatures oil and fat will ignite spontaneously and this presents a serious fire risk.

- » When food comes to the boil, reduce the temperature setting.
- » Using a lid will reduce cooking times and save energy by retaining the heat.
- » Minimise the amount of liquid or fat to reduce cooking times.
- » Start cooking on a high setting and reduce the setting when the food has heated through.

SIMMERING

- » Simmering occurs below boiling point, at around 85°C, when bubbles are just rising occasionally to the surface of the cooking liquid. It is the key to delicious soups and tender stews because the flavours develop without overcooking the food. You should also cook egg-based and flour thickened sauces below boiling point.
- » Some tasks, including cooking rice by the absorption method, may require a setting higher than the lowest setting to ensure the food is cooked properly in the time recommended.

SEARING STEAK

To cook juicy flavoursome steaks:

1. Stand the meat at room temperature for about 20 minutes before cooking.
2. Heat up a heavy-based frying pan.
3. Brush both sides of the steak with oil. Drizzle a small amount of oil into the hot pan and then lower the meat onto the hot pan.
4. Turn the steak only once during cooking. The exact cooking time will depend on the thickness of the steak and how cooked you want it. Times may vary from about 2 – 8 minutes per side. Press the steak to gauge how cooked it is – the firmer it feels the more 'well done' it will be.
5. Leave the steak to rest on a warm plate for a few minutes to allow it to relax and become tender before serving.

FOR STIR FRYING

1. Choose an ceramic compatible flat-based wok or a large frying pan.
2. Have all the ingredients and equipment ready. Stir-frying should be quick. If cooking large quantities, cook the food in several smaller batches.
3. Preheat the pan briefly and add two tablespoons of oil.
4. Cook any meat first, put it aside and keep warm.
5. Stir-fry the vegetables. When they are hot but still crisp, turn the cooking zone to a lower setting, return the meat to the pan and add your sauce.
6. Stir the ingredients gently to make sure they are heated through.
7. Serve immediately.

HEAT SETTINGS

The settings below are guidelines only. The exact setting will depend on several factors, including your cookware and the amount you are cooking. Experiment with the hob to find the settings that best suit you.

HEAT SETTING	SUITABILITY
1 - 2	<ul style="list-style-type: none">» Delicate warming for small amounts of food» Melting chocolate, butter, and foods that burn quickly» Gentle simmering» Slow warming
3 - 4	<ul style="list-style-type: none">» Reheating» Rapid simmering» Cooking rice
5 - 6	<ul style="list-style-type: none">» Pancakes
7 - 8	<ul style="list-style-type: none">» Sautéing» Cooking pasta
9	<ul style="list-style-type: none">» Stir-frying» Searing» Bringing soup to the boil» Boiling water

CLEANING AND MAINTENANCE

WHAT?	HOW?	IMPORTANT
<p>Everyday soiling on glass (fingerprints, marks, stains left by food or non-sugary spillovers on the glass)</p>	<ol style="list-style-type: none"> 1. Switch the power to the hob off. 2. Apply a ceramic hob cleaner while the glass is still warm (but not hot). 3. Rinse and wipe dry with a clean cloth or paper towel. 4. Switch the power to the hob back on. 	<ul style="list-style-type: none"> » When the power to the hob is switched off, there will be no 'hot surface' indication but the cooking zone may still be hot. Take extreme care. » Heavy-duty scourers, some nylon scourers and harsh/abrasive cleaning agents may scratch the glass. Always read the label to check if your cleaner or scourer is suitable. » Never leave cleaning residue on the hob: the glass may become stained.
<p>Boilovers, melts, and hot sugary spills on the glass</p>	<p>Remove these immediately with a fish slice, palette knife or razor blade scraper suitable for ceramic glass hob, but beware of hot cooking zone surfaces:</p> <ol style="list-style-type: none"> 1. Switch the power to the cooktop off at the wall. 2. Hold the blade or utensil at a 30° angle and scrape the soiling or spill to a cool area of the hob. 3. Clean the soiling or spill up with a dish cloth or paper towel. 4. Follow steps 2 to 4 for 'Everyday soiling on glass' above. 	<ul style="list-style-type: none"> » Remove stains left by melts and sugary food or spillovers as soon as possible. If left to cool on the glass, they may be difficult to remove or even permanently damage the glass surface. » Cut hazard: when the safety cover is retracted, the blade in a scraper is razor-sharp. Use with extreme care and always store safely and out of reach of children.
<p>Spillovers on the touch controls</p>	<ol style="list-style-type: none"> 1. Switch the power to the hob off. 2. Soak up the spill 3. Wipe the touch control area with a clean damp sponge or cloth. 4. Wipe the area completely dry with a paper towel. 5. Switch the power to the hob back on. 	<ul style="list-style-type: none"> » The hob may beep and turn itself off, and the touch controls may not function while there is liquid on them. Make sure you wipe the touch control area dry before turning the hob back on.

TROUBLESHOOTING

PROBLEM	POSSIBLE CAUSES	WHAT TO DO
The hob cannot be turned on.	No power	Make sure the hob is connected to the power supply and that it is switched on. Check whether there is a power outage in your home or area. If you've checked everything and the problem persists, call a qualified technician.
The touch controls are unresponsive.	The controls are locked.	Unlock the controls. See section 'Using your ceramic hob' for instructions.
The touch controls are difficult to operate.	There may be a slight film of water over the controls or you may be using the tip of your finger when touching the controls.	Make sure the touch control area is dry and use the ball of your finger when touching the controls.
The glass is being scratched.	Rough-edged cookware. Unsuitable, abrasive scourer or cleaning products being used.	Use cookware with flat and smooth bases. See 'Choosing the right cookware'. See 'Care and cleaning'
Some pans make crackling or clicking noises.	This may be caused by the construction of your cookware (layers of different metals vibrating differently).	This is normal for cookware and does not indicate a fault.

INSTALLATION

Cut out the work surface according to the sizes shown in the drawing. For the purpose of installation and use, a minimum of 50mm space shall be preserved around the hole. Be sure the thickness of the work surface is at least 30mm. Please select heat-resistant work surface material to avoid larger deformation caused by the heat radiation from the hotplate. As shown below:

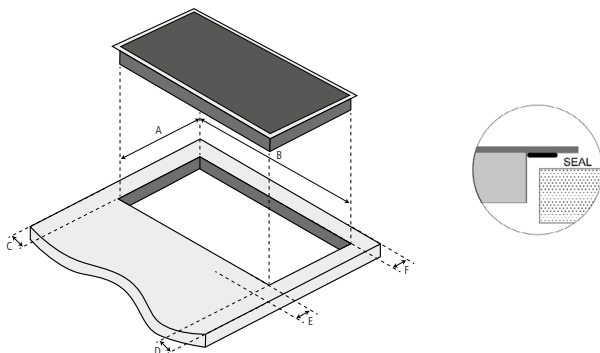

A	B	C	D	E	F
268 + 4	500 + 4	50mm min	50mm min	50mm min	50mm min
-0 mm	-0 mm				

The ceramic hob can be used on the table top of cabinet. The ceramic hob should be placed horizontally. As shown below:

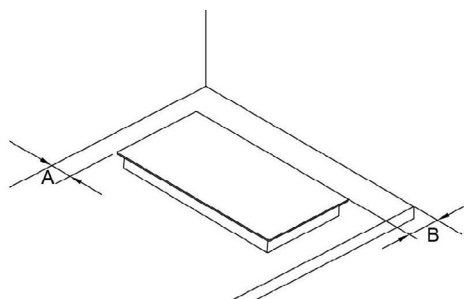

A	B
50mm min	50mm min

Always ensure the ceramic hob is well ventilated and the air inlet and outlet are not blocked. Ensure the hob is in the correct installation space. As shown below:

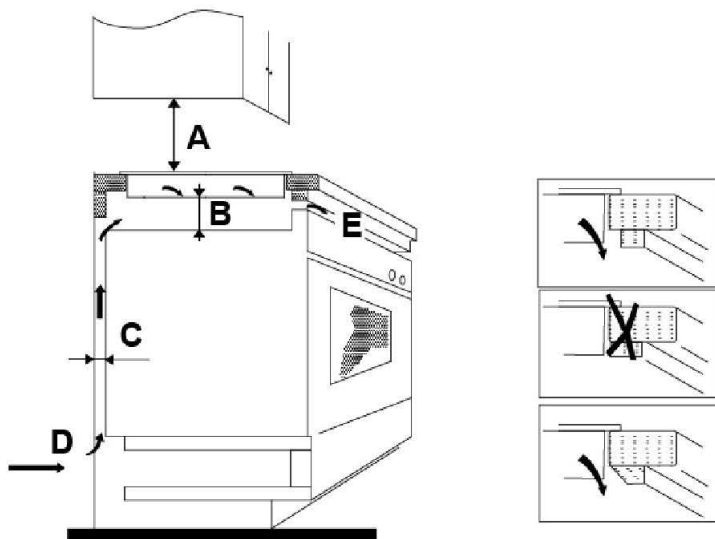

NOTE: For safety, the distance between the hob and the cupboard above the hob should be at least 760mm.

A (MM)	B (MM)	C (MM)	D	E
760	50 min	30 min	Air intake	Air exit 10mm

BEFORE INSTALLING THE HOB

- » The ceramic hob must be installed by qualified personnel or technicians. Please never conduct the installation by yourself.
- » Check the work surface is square and level, and no structural parts interfere with the space requirements.
- » Ensure the work surface is made of a heat-resistant material.
- » If the hob is installed above an oven, check the oven has a built-in cooling fan.
- » The installation must comply with all clearance requirements and applicable standards and regulations.
- » Ensure a suitable isolating switch providing full disconnection from the mains power supply is incorporated in the permanent wiring, mounted and positioned to comply with the local wiring rules and regulations.
- » The isolating switch must be of an approved type and provide a 3mm air gap contact separation in all poles (or in all active [phase] conductors if the local wiring rules allow for this variation of the requirements).
- » The isolating switch must be easily accessible to the customer once the hob is installed.
- » Consult local building authorities and by-laws if in doubt regarding installation.
- » Use heat-resistant and easy-to-clean finishes (such as ceramic tiles) for the wall surfaces.

AFTER INSTALLING THE HOB

- » Ensure the power supply cable is not accessible through cupboard doors or drawers.
- » Ensure there is an adequate flow of fresh air from outside the cabinetry to the base of the hob.
- » If the hob is installed above a drawer or cupboard space, a thermal protection barrier is installed below the base of the hob.
- » The isolating switch must be easily accessible by the customer.

CAUTIONS

- » The hob must not be mounted to cooking equipment, dishwashers and rotary dryers.
- » The ceramic hob shall be installed such that better heat radiation can be ensured to enhance its reliability.
- » The wall and induced heating zone above the work surface shall withstand heat.
- » To avoid any damage, the sandwich layer and adhesive must be resistant to heat.
- » A steam cleaner is not to be used.
- » This hob can be connected only to a supply with system independence no more than 0.427 ohm. In case necessary, please consult your supply authority for system impedance information.

BEFORE LOCATING THE FIXING BRACKETS

The unit should be placed on a stable, smooth surface (use the packaging). Do not apply force onto the controls protruding from the hob. Fix the hob on the work surface by screwing the four brackets on the bottom of hob (see picture) after installation. Adjust the bracket position to suit for different work surface's thickness.

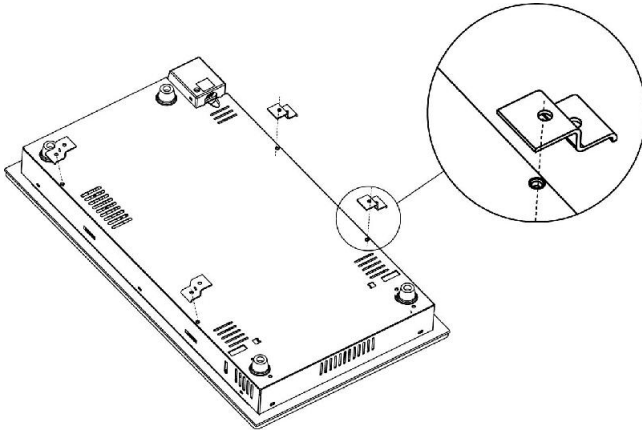

CONNECTING THE HOB TO THE MAINS POWER SUPPLY

The power supply should be connected in compliance with the relevant standard, or single-pole circuit breaker. The method of connection is shown below:

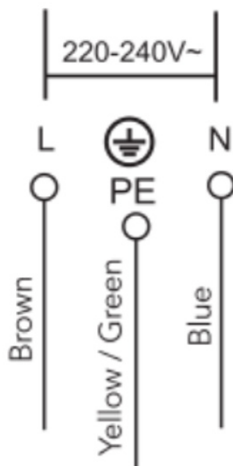

- » If the Cable is damaged or needs replacing, this should be done by an after-sales technician using the proper tools, so as to avoid any accidents.
- » If the appliance is being connected directly to the mains supply, an omnipolar circuit breaker must be installed with a minimum gap of 3mm between the contacts.
- » The installer must ensure that the correct electrical connection has been made and that it complies with safety regulations.
- » The cable must not be bent or compressed.
- » The cable must be checked regularly and only replaced by a properly qualified person.

TECHNICAL SPECIFICATION

HOB	C892C
COOKING ZONES	2 Zones
SUPPLY VOLTAGE	220-240V~ 50 or 60Hz
INSTALLED ELECTRIC POWER	2700 - 3000 W
PRODUCT SIZE D×W×H(MM)	288 X 520 X 55
BUILDING-IN DIMENSIONS A×B (MM)	268 X 500

NOTES:



Caple Service

Fourth Way

Avonmouth

Bristol

BS11 8DW

T: 0117 938 1900

E: service@caple.co.uk

www.caple.co.uk