



Integrated Dishwasher instruction manual

Di651



Contact Caple on 0117 938 7420 or for spare parts www.caple.co.uk





CONTENTS

WARNINGS	3
QUICK OPERATION GUIDE	9
CONTROL PANEL	10
DISHWASHER FEATURES	11
PRIOR TO USING FOR THE FIRST TIME	11
WATER SOFTENER	12
LOADING THE SALT INTO THE SOFTENER	13
FILL THE RINSE AID DISPENSER	14
FUNCTION OF DETERGENT	16
LOADING THE DISHWASHER BASKET	19
LOADING THE UPPER BASKET	21
LOADING THE LOWER BASKET	21
CUTLERY TRAY	24
WASH CYCLE TABLE	27
TURNING ON THE APPLIANCE	28
CHANGE THE PROGRAMME	28
AT THE END OF THE WASH CYCLE	29
CLEANING AND MAINTENANCE	30
FILTERING SYSTEM	30
CARING FOR THE DISHWASHER	32
INSTALLATION INSTRUCTION	34
INSTALLATION PREPARATION	34
TENSION ADJUSTMENT OF THE DOOR SPRING	38
CONNECTION OF DRAIN HOSES	38
DISHWASHER INSTALLATION STEPS	39
ELECTRICAL CONNECTION	41
COLD WATER CONNECTION	42
TROUBLESHOOTING TIPS	44
ERROR CODES	46
TECHNICAL INFORMATION	47
TECHNICAL FICHE	48
CAPLE CONTACT DETAILS	52

Please keep this instruction manual for future reference



WARNINGS

- This product is not designed for commercial use, it is a household appliance only. It is not intended to be used in:
 - 1) Staff kitchen areas in shops, offices and other working environments.
 - 2) Bed and breakfast type environments.
 - 3) By clients in hotels, motels and other residential type environments.
- This appliance can be used by children aged from 8 years and above and persons with reduced physical, sensory or mental capabilities or lack of experience and knowledge if they have been given supervision or instruction concerning use of the appliance in a safe way and understand the hazards involved. Children shall not play with the appliance. Cleaning and user maintenance shall not be made by children without supervision.
- This appliance is not intended for use by persons (including children)with reduced physical, sensory or mental capabilities, or lack of experience and knowledge, unless they have been given supervision or instruction concerning use of the appliance by a person responsible for their safety.
- This appliance is for indoor household use only.

Please keep this instruction manual for future reference

Instruction manual Di651 3





- To protect against the risk of electrical shock, do not immerse the unit, cord or plug in water or other liquid.
- Please unplug before cleaning or performing maintenance on the appliance.
- Use a slightly moistened soft cloth with mild soap, and then use a dry cloth to wipe it again
- This appliance must be earthed. In the event of a malfunction or breakdown, earthing will reduce the risk of an electric shock by providing a path of less resistance of electric current. This appliance is equipped with a cord having an equipment-earthing conductor and a grounding plug.
- The plug must be plugged into an appropriate outlet that is installed and earthed in accordance with all local codes and regulations.
- Improper connection of the equipment-earthing conductor can result in the risk of an electric shock.
- Check with a qualified electrician or Caple service representative if you are in doubt whether the appliance is properly grounded.
- Do not modify the plug provided with the appliance; If it does not fit the outlet.
- Have a proper outlet installed by a qualified electrician.

Please keep this instruction manual for future reference



- Do not abuse, sit on, or stand on the door or dish rack of the dishwasher.
- Do not operate your dishwasher unless all enclosure panels are properly in place.
- Open the door very carefully when the dishwasher is operating, there is a risk of water squirting out.
- Do not place any heavy objects on or stand on the door when it is open. The appliance could tip forward.
- When loading items to be washed:
 - 1) Locate sharp items so that they are not likely to damage the door seal
 - 2) Warning: Knives and other utensils with sharp points must be loaded in the basket with their points down or placed in a horizontal position.
- Check that the detergent powder is empty after completion of the wash cycle.
- Do not wash plastic items unless they are marked dishwasher safe or the equivalent.
- For plastic items not marked, check the manufacturer's recommendations.
- Use only detergent and rinse additives designed for an automatic dishwasher.
- Never use soap, laundry detergent, or hand washing detergent in your dishwasher.

Please keep this instruction manual for future reference





- Children should be supervised to ensure that they do not play with the appliance.
- The door should not be left open, since this could increase the risk of tripping.
- The appliance may only be used with correctly adjusted door springs.
- If the supply cord is damaged, it must be replaced by Caple, its service agent or a similarly qualified person in order to avoid a hazard.
- During installation, the power supply must not be excessively or dangerously bent or flattened.
- The dishwasher must not be installed under a hob.
- Do not tamper with controls.
- The appliance is to be connected to the water mains using new hose sets and that old hose-sets should not be reused.
- The maximum number of place settings to be washed is 15.
- The maximum permissible inlet water pressure is 1MPa.
- The minimum permissible inlet water pressure is 0.04MPa.

Please keep this instruction manual for future reference





WARNINGS

- Packaging material could be dangerous for children!
- For disposing of package and the appliance please go to a recycling centre. Therefore cut off the power supply cable and make the door closing device unusable.
- Cardboard packaging is manufactured from recycled paper and should be disposed in the waste paper collection for recycling.
- By ensuring this product is disposed of correctly, you will help prevent potential negative consequences for the environment and human health, which could otherwise be caused by inappropriate waste handling of this product.
- For more detailed information about recycling of this product, please contact your local council office and your household waste disposal service.
- DISPOSAL: Do not dispose this product as unsorted municipal waste. Collection of such waste separately for special treatment is necessary.

Please keep this instruction manual for future reference

Instruction manual Di651 7



ENVIRONMENTAL PROTECTION

Waste electrical products should not be disposed of with household waste. Please recycle where facilities exist. Check with your Local Authority or retailer for recycling advice. This appliance is marked according to the European directive 2002/96/EC on Waste Electrical and Electronic Equipment (WEEE).

By ensuring this product is disposed of correctly, you will help prevent potential negative consequences for the environment and human health, which could otherwise be caused by inappropriate waste handling of this product. The symbol on the product indicates that this product may not be treated as household waste. Instead it shall be handed over to the applicable collection point for the recycling of electrical and electronic equipment. Disposal must be carried out in accordance with local environmental regulations for waste disposal.

For more detailed information about treatment, recovery and recycling of this product, please contact your local council, your household waste disposal service or the retailer where you purchased the product

CE DECLARATIONS OF CONFORMITY

This appliance has been manufactured to the strictest standards and complies with all applicable legislation, Low Voltage Directive (LVD) and Electromagnetic Compatibility (EMC).

Please keep this instruction manual for future reference



QUICK OPERATION GUIDE

For detailed operating method read the corresponding content on the instruction manual.

Switch on the appliance	Open the door, press the On/Off button to switch on the appliance	
Fill the detergent dispenser	<p>Compartment A: With each wash cycle.</p> <p>Compartment B: For programmes with prewash only. (Follow the user instructions)</p>	
Check the rinse aid level	<p>Mechanical Indicator C: Electric indicator on control panel</p>	
Check the regeneration salt level	Electric indicator on control panel	
Load the baskets	Scrape off any large amount of leftover food. Soften remnants of burnt food in pans, then load the baskets. Refer to the dishwasher loading instructions	
Select a programme	Press the Programme Button that you require and it will light up. (See the section entitled "Operation instruction")	
Running the dishwasher	Close the door. The machine will start working at once.	



















Changing the programme	<ol style="list-style-type: none"> 1. A running cycle can only be modified if it has been running for a short time. Otherwise the detergent may have already been released and the water already drained. If this is the case, the detergent dispenser must be refilled. 2. Open the door. 3. Press the Rapid Programme Button for 3 seconds to cancel the running programme. 4. Select a new programme. 5. Close the dishwasher door to restart the dishwasher. 	<p>WARNING Open the door carefully. Hot steam may escape when the door is opened!</p>
Add forgotten dishes in the dishwasher.	<ol style="list-style-type: none"> 1. Open the door a little to stop the dishwasher. 2. After the spray arms stop working, you can open the door completely. 3. Add the forgotten dishes. 4. Close the door, the dishwasher will start running again 	
If the appliance is switched off during a wash cycle	If the appliance is switched off during a wash cycle, when switched on again, please re-select the washing cycle and operate the dishwasher according to the original Power-on state).	

Switch off the appliance	When the working cycle has finished, the buzzer of the dishwasher will sound 8 times, then stop. Turn off the appliance using the On/Off Button. Since the appliance is standing by, it will power off automatically after 30 minutes without any operation.
Unload the Dishwasher	WARNING: wait a few minutes (about 15 minutes) before unloading the dishwasher to avoid handling the dishes and utensils while they are still hot and more susceptible to break. They will also dry better. Unload the appliance, starting from the lower basket

Please keep this instruction manual for future reference

CONTROL PANEL



1.  Power Button- touch on and off.
2. Program Buttons-touch to select the Program, corresponding indicator will light:
 -  Auto
 -  Intensive
 -  Normal
 -  ECO
 -  Glass
 -  90Min
 -  Rapid
3. Screen - Shows the program time and delay time:
 - 3:05* Eg: program time
 - 4:09* Delay time
4. Status Indicators:
 -  Faucet is not open
 -  Rinse detergent needs to be refilled
 -  Salt needs to be refilled
5. Delay Buttons:
 -  Increase
 -  Reduce
6. Alt Function Buttons and indicators:
 -  Upper basket
 -  Lower basket
7. Program functions, only one function can be selected in a cycle:
 -  Extra Drying, to improve the drying efficiency
 -  Power Wash, to improve the cleaning efficiency
 -  Express wash, to reduce the program time

Please keep this instruction manual for future reference



DISHWASHER FEATURES

Front view

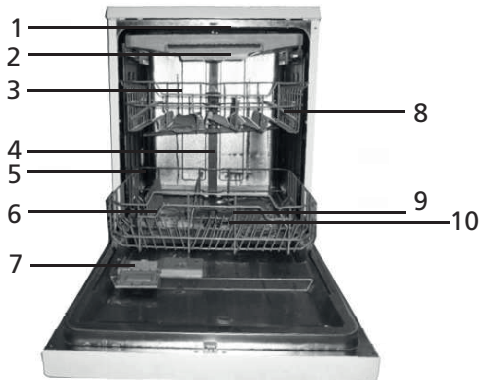

1. Top spray arm
2. Cutlery tray
3. Upper basket
4. Inner pipe
5. Lower basket
6. Salt container

Back view



7. Dispenser
8. Cup shelf
9. Spray arms
10. Filter assembly
11. Inlet pipe connector
12. Drain pipe

PRIOR TO USING FOR THE FIRST TIME

Before using your dishwasher for the first time:

- Set the water softener
- Add 1.5Kg dishwasher salt and then fill the salt container with water
- Fill the rinse aid dispenser
- Fill in detergent

Please keep this instruction manual for future reference

Instruction manual Di651 11



WATER SOFTENER

The water softener must be set manually, using the water hardness dial.

The water softener is designed to remove minerals and salts from the water, which would have a detrimental or adverse effect on the operation of the appliance.

The higher the content of these minerals and salts, the harder your water is.

The softener should be adjusted according to the hardness of the water in your area. Your local Water Authority can advise you on the hardness of the water in your area.

ADJUSTING SALT CONSUMPTION

The dishwasher is designed to allow for adjustment in the amount of salt consumed based on the hardness of the water used. This is intended to optimise and customise the level of salt consumption.

Please follow the steps below for adjustment in salt consumption

1. Open the door and Switch on the appliance;
2. Press the Rapid Program button for more than 5 seconds to start the water softener setting within 60 seconds after the appliance was switched on (The Salt and Rinse aid warning lights will be on periodically when it is in this setting mode);
3. Press the Rapid Program button to select the proper set according to your local environment, the sets will change in the following sequence: H1->H2->;
4. Press the Power button to end the set up model.

WATER HARDNESS				Selector Position	Salt consumption (gram/cycle)
°dH	°fH	°Clarke	mmol/l		
0~5	0~9	0~6	0~0.94	H1	0
6-11	10-20	7-14	1.0-2.0	H2	9
12-17	21-30	15-21	2.1-3.0	H3	12
18-22	31-40	22-28	3.1-4.0	H4	20
23-34	41-60	29-42	4.1-6.0	H5	30
35-55	61-98	43-69	6.1-9.8	H6	60

NOTE: 1

°dH=1.25 °Clarke=1 1.78°fH=0.178mmol/l

°dH: German degree

°fH: French degree

°Clark: British degree

NOTE: 2

The manufactory setting: H3
(EN 50242)





Contact your local water board for information on the hardness of your water supply.

WATER SOFTENER

The hardness of the water varies from place to place. If hard water is used in the dishwasher, deposits will form on the dishes and utensils.

The appliance is equipped with a special softener that uses a salt container specifically designed to eliminate lime and minerals from the water.

LOADING THE SALT INTO THE SOFTENER

Always use salt intended for use with dishwashers.

The salt container is located beneath the lower basket and should be filled as explained in the following:

ATTENTION!

- Only use salt specifically designed for the use in dishwashers! Every other type of salt not specifically designed for the use in a dishwasher, especially table salt, will damage the water softener. In case of damages caused by the use of unsuitable salt the manufacturer does not give any warranty nor is liable for any damages caused.
- Only fill with salt just before starting one of the complete washing programs. This will prevent any grains of salt or salty water, which may have been spilled, remaining on the bottom of the machine for any period of time, which may cause corrosion.

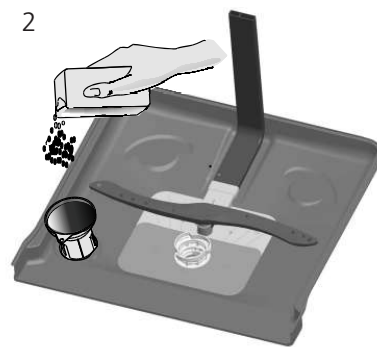
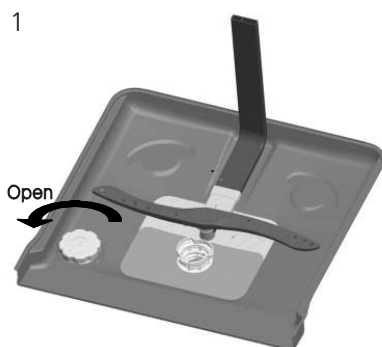

Please keep this instruction manual for future reference





- After the lower basket has been removed, unscrew and remove the cap from the salt container. **(1)**
- Place the end of the funnel (supplied) into the hole and insert about 1.5kg of dishwasher salt.
- Fill the salt container with water, It is normal for a small amount of water to come out of the salt container. **(2)**
- After filling the container, screw the cap tightly back on, turning clockwise.
- The salt warning light will turn off after the salt container has been filled with salt.
- Immediately after filling the salt into the salt container, a washing program should be started. Otherwise the filter system, pump or other important parts of the machine may be damaged by salty water.

NOTE:

1. The salt container must only be refilled when the salt warning light in the control panel comes on. Depending on how well the salt dissolves, the salt warning light may still be on even though the salt container is filled.
2. If there are spills of the salt, a soak or a rapid program should be run to remove the excessive salt.

FILL THE RINSE AID DISPENSER

RINSE AID DISPENSER

The rinse aid is released during the final rinse to prevent water from forming droplets on your dishes, which can leave spots and streaks. It also improves drying by allowing water to roll off the dishes. Your dishwasher is designed to use liquid rinse aids. The rinse aid dispenser is located inside the door next to the detergent dispenser. To fill the dispenser, open the cap and pour the rinse aid into the dispenser until the level indicator turns completely black. The volume of the rinse aid container is about 110ml.

FUNCTION OF RINSE AID

Rinse aid is automatically added during the last rinse, ensuring thorough rinsing, and spot and streak free drying.

ATTENTION!

Only use branded rinse aid for dishwasher. Never fill the rinse aid dispenser with any other substances (e.g. Dishwasher cleaning agent, liquid detergent). This would damage the appliance.

Please keep this instruction manual for future reference



WHEN TO REFILL THE RINSE AID DISPENSER

The rinse-aid warning light in the control panel will illuminate when the dispenser needs re filling. You can also estimate the remaining amount from the colour of the optical level indicator "C" located next to the cap. When the rinse-aid container is full, the whole indicator will be dark. As the rinse-aid diminishes, the size of the dark dot decreases. You should never let the rinse aid level fall 1 / 4 full.

As the rinse aid diminishes, the size of the black dot on the rinse aid level indicator changes, as illustrated below:

- Full
- $\frac{3}{4}$ full
- $\frac{1}{2}$ full
- $\frac{1}{4}$ full - Should refill to eliminate spotting
- Empty

C (Rinse-Aid indicator)

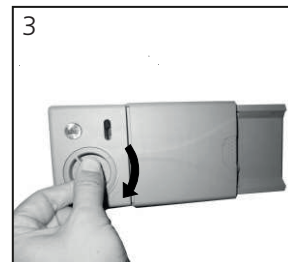
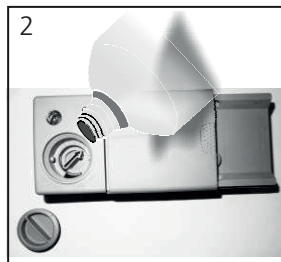
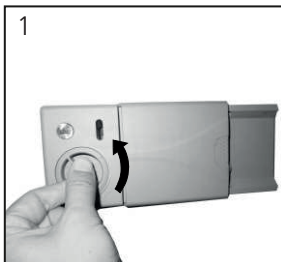

1. To open the dispenser, turn the cap to the "open" (left) arrow and lift it out
2. Pour the rinse aid into the dispenser, being careful not to overfill
3. Replace the cap by inserting it aligned with "open" arrow and turning it to the closed (right) arrow.

NOTE:

Clean up any rinse aid spilled during filling with an absorbent cloth to avoid excessive foaming during the next wash. Don't forget to replace the cap before you close dishwasher door.

Please keep this instruction manual for future reference





ADJUSTING RINSE AID DISPENSER

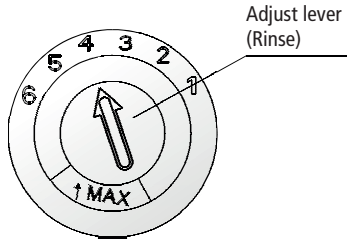

The rinse aid dispenser has six settings. Always start with the dispenser set on "4". If spots and poor drying are a problem, increase the amount of rinse aid dispensed by removing the dispenser lid and rotating the dial to "5". If the dishes still are not drying properly or are show spots, adjust the dial to the next higher lever until your dishes are spot-free. The recommended setting is "4". (Factory value is "4".)

NOTE:

Increase the dose if there are drops of water or lime spots on the dishes after washing. Reduce it if there are sticky whitish stains on your dishes or a bluish film on glassware or knife blades.

FUNCTION OF DETERGENT

Detergents with its chemical ingredients are necessary to remove dirt, crush dirt and transport it out of the dishwasher. Most of the commercial quality detergents are suitable for this purpose.

ATTENTION!

Proper Use of Detergent

Use only detergent specifically made for the use in dishwashers. Keep your detergent fresh and dry. Don't put powdered detergent into the dispenser until you're ready to wash dishes.

DETERGENTS

There are 3 sorts of detergents

1. With phosphate and with chlorine
2. With phosphate and without chlorine
3. Without phosphate and without chlorine

Please keep this instruction manual for future reference





Normally new pulverised detergent is without phosphate. Thus the water softener function of phosphate is not given. In this case we recommend to fill salt in the salt container even when the hardness of water is only 6 dH. If detergents without phosphate are used in the case of hard water often white spots appear on dishes and glasses. In this case please add more detergent to reach better results. Detergents without chlorine do only bleach a little. Strong and coloured spots will not be removed completely. In this case please choose a program with a higher temperature.

CONCENTRATED DETERGENT

Based on their chemical composition, detergents can be split in two basic types:

- conventional, alkaline detergents with caustic components
- low alkaline concentrated detergents with natural enzymes

DETERGENT TABLETS

Detergent tablets of different brands dissolve at different speeds. For this reason some detergent tablets cannot dissolve and develop their full cleaning power during short programs. Therefore please use long programs when using detergent tablets, to ensure the complete removal of detergent residuals.

DETERGENT DISPENSER

The dispenser must be refilled before the start of each wash cycle following the instructions provided in the wash cycle table . Your dishwasher uses less detergent and rinse aid than Conventional dishwashers. Generally, only one tablespoon of detergent is needed for a normal wash load. More heavily soiled items need more detergent. Always add the detergent just before starting the dishwasher, otherwise it could get damp and will not dissolve properly.

AMOUNT OF DETERGENT TO USE

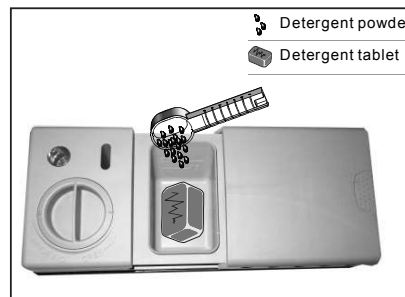
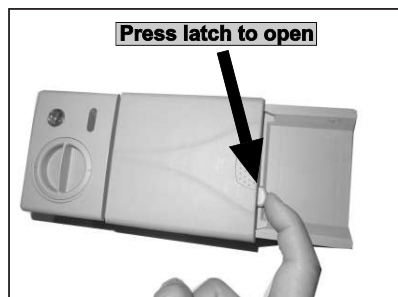

Please keep this instruction manual for future reference





NOTE:

- If the lid is closed: press release button. The lid will spring open
- Always add the detergent just before starting each wash cycle.
- Only use branded detergent aid for dishwasher.

WARNING:

Dishwasher detergent is corrosive!
Take care to keep it out of reach of children.

FILL THE DETERGENT DISPENSER

Fill the detergent dispenser with detergent. The marking indicates the dosing levels, as illustrated on the right:



A The place of main wash cycle detergent placed.

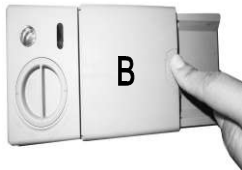

B The place of pre-wash cycle detergent placed

Please observe the manufacturers dosing and storage Recommendations as stated on the detergent packaging.

Close the lid and press until it locks in place.

If the dishes are heavily soiled, place an additional detergent dose in the pre-wash detergent chamber. This detergent will take effect during the pre-wash phase.

NOTE:

- You find information about the amount of detergent for the single programme on the last page.
- Please aware, that according to the level soiling and the specific hardness of water differences are possible.
- Please observe the manufacturer's recommendations on the detergent packaging.

Please keep this instruction manual for future reference





CLOSE THE DETERGENT DISPENSER

If your dishes are only moderately dirty, you may be able to use less detergent than recommended.

- Close compartment;
Press down the lid (1) until it clicks shut (2).
- If you are using detergent in tablet form, read the manufacturer recommendations on the packaging in order to determine where the tablets should be placed inside the dishwasher (e.g. in cutlery basket, detergent compartment, etc.). Make sure that the lid on the detergent compartment is closed, even if you are using tablets.

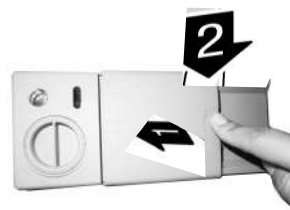

LOADING THE DISHWASHER BASKETS

RECOMMENDATION

- Consider buying utensils which are identified as dishwasher-proof.
- Use a mild detergent that is described as 'kind to dishes'. If necessary, seek further information from the detergent manufacturers.
- For particular items, select a program with as low a temperature as possible.
- To prevent damage, do not take glass and cutlery out of the dishwasher immediately after the programme has ended.

THE FOLLOWING CUTLERY / DISHES:

ARE NOT SUITABLE

- Cutlery with wood, horn china or mother-of-pearl handles
- Plastic items that are not heat resistant
- Older cutlery with glued parts that are not temperature resistant
- Bonded cutlery items or dishes
- Pewter or copper items
- Crystal glass
- Steel items subject to rusting
- Wooden platters
- Items made from synthetic fibres

Please keep this instruction manual for future reference

Instruction manual Di651 19





ARE OF LIMITED SUITABILITY

- Some types of glasses can become dull after a large number of washes
- Silver and aluminum parts have a tendency to discolour during washing
- Glazed patterns may fade if machine washed frequently

BEFORE OR AFTER LOADING

THE DISHWASHER BASKET

(For best performance of the dishwasher, follow these loading guidelines. Features and appearance of baskets and cutlery baskets may vary from your model.) Scrape off any large amounts of leftover food. Soften remnants of burnt food in pans. It is not necessary to rinse the dishes under running water.

Place objects in the dishwasher in following way:

1. Items such as cups, glasses, pots/pans, etc. are faced downwards.
2. Curved items, or ones with recesses, should be loaded aslant so that water can run off.
3. All utensils are stacked securely and can not tip over.
4. All utensils are placed in the way that the spray arms can rotate freely during washing.

NOTE: Very small items should not be washed in the dishwasher as they could easily fall out of the basket.

- Load hollow items such as cups, glasses, pans etc. With the opening facing downwards so that water cannot collect in the container or a deep base
- Dishes and items of cutlery must not lie inside one another, or cover each other.
- To avoid damage to glasses, they must not touch.
- Load large items which are most difficult to clean into the lower basket.
- The upper basket is designed to hold more delicate and lighter dishware such as glasses, coffee and tea cups
- Long bladed knives stored in an upright position are a potential hazard!
- Long and/or sharp items of cutlery such as carving knives must be positioned horizontally in the upper basket.
- Please do not overload your dishwasher. This is important for good results and for reasonable consumption of energy.

Please keep this instruction manual for future reference



REMOVING THE DISHES

To prevent water dripping from the upper basket into the lower basket, we recommend that you empty the lower basket first and then the upper basket.

LOADING THE UPPER BASKET

The upper basket is designed to hold more delicate and lighter dishware such as glasses, coffee and tea cups and saucers, as well as plates, small bowls and shallow pans (as long as they are not too dirty). Position the dishes and cookware so that they will not get moved by the spray of water.

/N

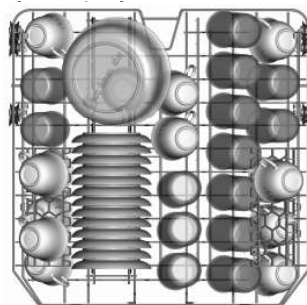

Please be reminded that:

- Pots, serving bowls, etc, must always be placed top down.
- Deep pots should be slanted to allow water to flow out.
- The Bottom Basket features folding spikes so that larger or more pots and pans can be loaded.

LOADING THE LOWER BASKET

We suggest that you place large items and the most difficult to clean items into the lower basket: such as pots, pans, lids, serving dishes and bowls, as shown in the figure (right). It is preferable to place serving dishes and lids on the side of the racks in order to avoid blocking the rotation of the top spray arm.

/N

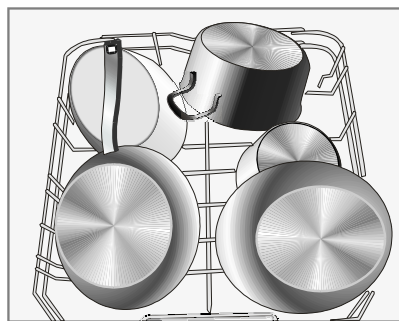

Please keep this instruction manual for future reference



LOADING THE BASKETS:

1. Upper basket

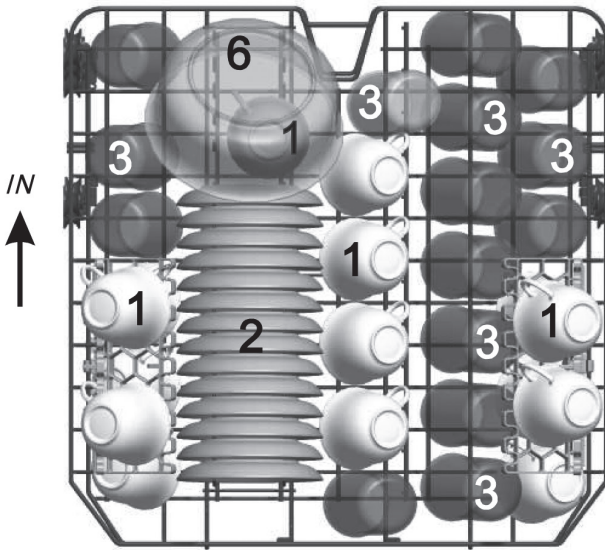

Cups



Saucers



Glasses



Small serving bowl



Medium serving bowl



Large serving bowl

2. Lower basket

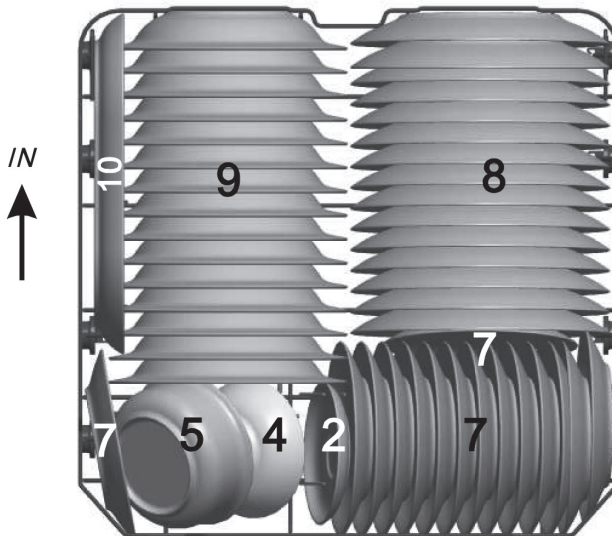

Dessert dishes



Dinner plates



Soup plates



Oval plates

Please keep this instruction manual for future reference





ADJUSTING THE UPPER BASKET

The height of the upper basket can be easily adjusted in order to create more space for large utensils both for the upper /lower basket. The height of the upper basket can be adjusted by lifting up the basket to lock in the upper position, and to lower the basket, simply pull the handle up and lower the basket as shown here:



Adjust handle

Lift the basket for upper position



Adjust handle

Pull handle and lower for lower position

FOLDING BACK THE CUP SHELVES

For better stacking of pots and pans, the cup shelves can be folded down as show in the right.

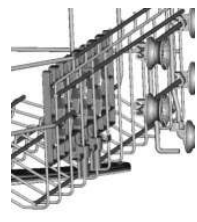
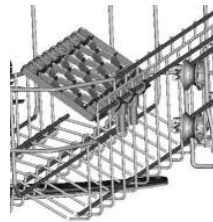

FOLDING SPIKES OF LOWER BASKET

For better stacking of pots and pans, the spikes can be folded down as show in the picture to the right.



Please keep this instruction manual for future reference





CUTLERY TRAY 5 AVAILABLE POSITIONS:

Mode 1



Position one: lift the left tray up, both left and right trays are sloping.

Mode 2

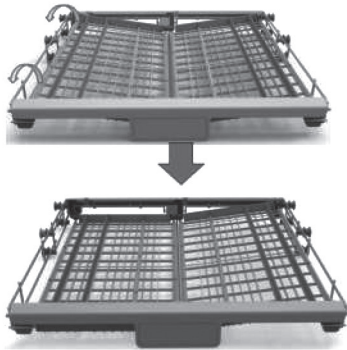

Position two: adjust the left tray to lower position, left tray is flat and right tray is sloping.

Mode 3



Position three: lift the right tray up, both left and right trays are flat.

Please keep this instruction manual for future reference





Mode 4

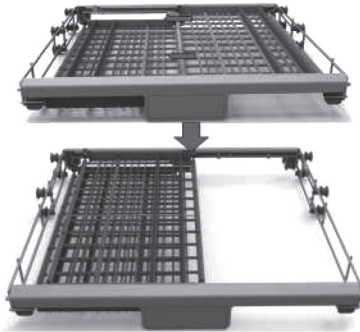

Position Four: Move the right tray from right to left, two tray are overlapping.

Mode 5



Position Five: Remove the right tray from the tray, only has the left tray.

Please keep this instruction manual for future reference

Instruction manual Di651 25









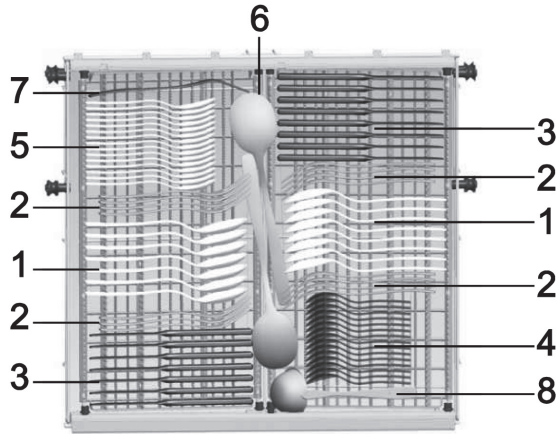

CUTLERY TRAY

Arrange the cutlery in the tray as shown below. To make unloading much easier, cutlery should be grouped in zones, one for knives, one for forks, one for spoons, etc. Spoon heads should be placed in contact with at least one of the serrated retainers on the base of the cutlery tray to ensure that water runs off them freely.



- | | | | |
|----------------|---|-------------------|---|
| 1. Soup spoons |  | 5. Dessert spoons |  |
| 2. Forks |  | 6. Serving spoons |  |
| 3. Knives |  | 7. Serving forks |  |
| 4. Teaspoons |  | 8. Gravy ladies |  |







WARNING:

Do not let any item extend through the bottom of the tray.

Please keep this instruction manual for future reference



WASH CYCLE TABLE

Programme	Cycle Selection Information	Description of cycle	Detergent Pre/main	Running time (min)	Energy (Kwh)	Water (L)	Rinsee Aid
Auto 	Auto sensing wash, lightly, normally or heavily soiled crockery, with or with out dried-on food	Pre-wash (45°C) Autowash(45-55°C) Rinse Rinse(65°C) Drying	5/32.5g 1or2 pieces	150	0.9~1.3	11~15	★
Intensive 	For heaviest soiled crockery, and normally soiled pots, pans, dishes etc with dried on soiling	Pre-wash(50°C) Wash (60°C) Rinse Rinse Rinse(70°C) Drying	5/32.5g 1or2 pieces	175	1.6	17.5	★
Normal 	For normally soiled loads, such as pots, plates, glasses and lightly soiled pans.	Pre-wash(45°C) Wash (55°C) Rinse Rinse (65°C) Drying	5/32.5g 1or2 pieces	185	1.3	13.5	★
ECO (*EN 50242)	This is standard programme, it is suitable to clean normally soiled tableware and it is the most efficient programme in terms of its combined energy and water consumption for that type of tableware.	Pre-wash Wash (45°C) Rinse(55°C) Drying	5/32.5g 1or2 pieces	220	0.84	10	★
Glass 	For lightly soiled crockery and glass.	Pre-wash Wash (40°C) Rinse Rinse(60°C) Drying	5/32.5g 1 pieces	130	0.9	13	★
90 Min 	For normally soiled loads that need a quick wash.	wash (65°C) Rinse Rinse (65°C) Drying	37.5g 1 pieces	90	1.35	12.5	★
Radid 	A shorter wash for lightly soiled loads and quick wash.	Wash (45°C) Rinse (55°C) Rinse (55°C)	27g	30	0.75	11	

★ Fill rinse-aid into the dispenser





NOTE: EN 50242 :

This programme is the test cycle. The information for comparability test in accordance with EN 50242, as follows

- Capacity: 15 settings
- Position Upper basket: upper wheels on rails
- Rinse aid setting: 6
- Pl:0.49w;Po:0.45w

TURNING ON THE APPLIANCE

Starting a wash cycle:

- Pull out the lower and upper baskets, load the dishes and push them back. It is recommended to load the lower basket first, then the upper one (see the section entitled "Loading the Dishwasher").
- Pour in the detergent (see the section entitled Salt, Detergent and Rinse Aid).
- Insert the plug into the socket. The power supply is 220-240 VAC /50 HZ, the specification of the socket is 10A 250VAC. Make sure that the water supply is turned on to full pressure.
- Open the door, press the power button, and the On/Off light will turn on.
- Press the required program Button:

Once a program is selected, the programme will light. Then close the door, the dishwasher begins to start.

*Press the + or - buttons to set the delayed timer before closing the door if you wish to delay the start time.

CHANGE THE PROGRAMME

- A cycle that is underway can only be modified if it has only been running for a short time. Otherwise, the detergent may have already been released, and the appliance may have already drained the wash water. If this is the case, the detergent dispenser must be refilled (see the section entitled "Loading the Detergent").
- Open the door, press the Rapid Program button for 3 seconds, the machine will be in standby state, then you can change the program to the desired cycle setting (see the section entitled "Starting a wash cycle").

NOTE: If you open the door during a wash cycle, the machine will pause. The program light will stop blinking and the buzzer will sound every minute until you close the door. After you close the door, the machine will continue working again.

Please keep this instruction manual for future reference



FORGOT TO ADD A DISH

A forgotten dish can be added any time before the detergent cap opens.:

- Open the door a little.
- After the spray arms stop working, you can open the door completely
- Add forgotten dishes
- Close the door
- The dishwasher will start running again

AT THE END OF THE WASH CYCLE

When the working cycle has finished, the buzzer of the dishwasher will sound for 8 seconds, then stop. Turn off the appliance using the ON/OFF button, shut off the water supply (if connected to tap only) and open the door of the dishwasher.

Wait for a few minutes before unloading the dishwasher to avoid handling the dishes and utensils while they are still hot and more susceptible to breakage. They will also dry better

SWITCH OFF THE DISHWASHER

The program light is on but is not blinking, only in this case the programme has ended.

1. Open the door. Switch off the dishwasher by pressing the ON/OFF button.
2. Turn off the water tap (if not plumbed into mains water supply).

OPEN THE DOOR CAREFULLY

Hot dishes are sensitive to knocks. The dishes should therefore be allowed to cool down around 15 minutes before removing from the appliance.

Open the dishwasher's door, leave it ajar and wait a few minutes before removing the dishes. In this way they will be cooler and the drying will be improved.

UNLOADING THE DISHWASHER

It is normal that the dishwasher is wet inside.

Empty the lower basket first and then the upper one. This will avoid water dripping from the upper Basket onto the dishes in the lower one.

WARNING:

It is dangerous to open the door during a wash cycle, because the hot water or steam may scald you.

Please keep this instruction manual for future reference



CLEANING AND MAINTENANCE

FILTERING SYSTEM

The filter prevents larger remnants of food or other objects from getting inside the pump. The residues may block the filter, in this case they must be removed.

The filter system consists of a coarse filter, a flat (Main filter) and a microfilter (Fine filter).

2



1. Main filter

Food and soil particles trapped in this filter are pulverized by a special jet on the lower spray arm and washed down to drain

1

2. Coarse filter

Larger items, such as pieces of bones or glass, that could block the drain are trapped in the coarse filter. To remove the items caught by the filter, gently squeeze the tap on the top of this filter and lift out.

3



3. Fine filter

This filter holds soil and food residues in the sump area and prevents it from being deposited on the dishes during wash cycle.

Filter assembly

The filter efficiently removes food particles from the wash water, allowing it to be recycled during the cycle. For best performance and results, the filter must be cleaned regularly. For this reason, it is a good idea to remove the larger food particles trapped in the filter after each wash cycle by rinsing the semicircular filter and cup under running water. To remove the filter device, turn the filter anti clockwise and pull the filter in the upwards direction.

WARNING

- The dishwasher must never be used without the filters.
- Improper replacement of the filter may reduce the performance level of the appliance and damage dishes and utensils.

Please keep this instruction manual for future reference





Step 1
Turn the filter in anti-clockwise direction

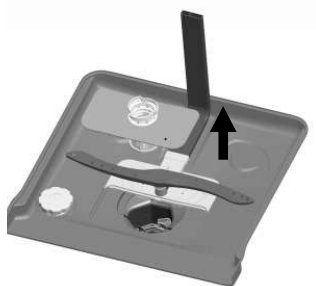

Step 2
lift the filter assembly up

NOTE:

Reverse these steps to re install the filter

Remarks

- Inspect the filters for blocking after every time the dishwasher has been used.
- By unscrewing the coarse filter, you can remove the filter system. Remove any food remnants and clean the filters under running water.

NOTE:

The entire filter assembly should be cleaned once a week

CLEANING THE FILTER

To clean the coarse filter and the fine filter, use a cleaning brush. Reassemble the filter parts as shown in the figures on the previous page and reinsert the entire assembly in the dishwasher.

WARNING:

When cleaning the filters, don't knock on them. Otherwise, the filters could be contorted and the performance of the dishwasher could be decreased.

Please keep this instruction manual for future reference



CARING FOR THE DISHWASHER

The control panel can be cleaned by using a lightly dampened cloth. After cleaning, make sure to dry it thoroughly.

For the exterior, use a good appliance polish wax. Never use sharp objects, scouring pads or harsh cleaners on any part of the dishwasher.

CLEANING THE DOOR.

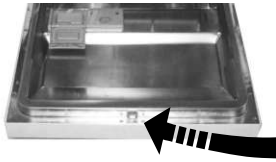

To clean the edge around the door, you should use only a soft warm, damp cloth. To avoid penetration of water into the door lock and electrical components, do not use a spray cleaner of any kind.

WARNING:

- Never use a spray cleaner to clean the door panel as it may damage the door lock and electrical components.
- Abrasive agents or some paper towels should not be used because of the risk of scratching or leaving spots on the stainless steel surface

PROTECT AGAINST FREEZING

Please take frost protection measures on the dishwasher in winter. Every time after washing cycles please operate as follows:

1. Cut off the electrical power to the dishwasher.
2. Turn off the water supply and disconnect the water inlet pipe from the water valve.
3. Drain the water from the inlet pipe and water valve.
(Use a pan to gather the water)
4. Reconnect the water inlet pipe to the water valve.
5. Remove the filter at the bottom of the dishwasher and use a sponge to soak up water in the sump.

Please keep this instruction manual for future reference



NOTE:

If your dishwasher cannot work because of the ice build up, please contact a qualified plumber or serviceman.

CLEANING THE SPRAY ARMS

It is necessary to clean the spray arms regularly as hard water chemicals will clog the spray arm jets and bearings.

To remove the upper spray arm, hold the nut, rotate the arm clockwise to remove it.

To remove the lower spray arm, pull out the spray arm upward.

Wash the arms in warm soapy water and use a soft brush to clean the jets. Replace them after rinsing them thoroughly.

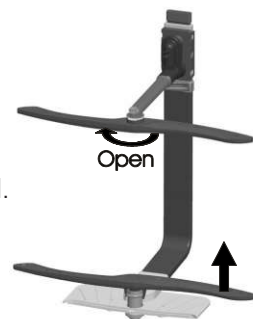

HOW TO KEEP YOUR DISHWASHER IN SHAPE

AFTER EVERY WASH

After every wash, turn off the water supply to the appliance and leave the door slightly open so that moisture and odours are not trapped inside.

REMOVE THE PLUG

Before cleaning or performing maintenance, always remove the plug from the socket.

NO SOLVENTS OR ABRASIVE CLEANING

To clean the exterior and rubber parts of the dishwasher, do not use solvents or abrasive cleaning products. Only use a cloth with warm soapy water. To remove spots or stains from the surface of the interior, use a cloth dampened with water and a little vinegar, or a cleaning product made specifically for dishwashers.

WHEN NOT IN USE FOR A LONG TIME

It is recommended that you run a wash cycle with the dishwasher empty and then remove the plug from the socket, turn off the water supply and leave the door of the appliance slightly open. This will help the door seals to last longer and prevent odours from forming within the appliance.

MOVING THE APPLIANCE

If the appliance must be moved, try to keep it in the vertical position. If absolutely necessary, it can be positioned on its back.

SEALS

One of the factors that cause odours to form in the dishwasher is food that remains trapped in the seals. Periodic cleaning with a damp sponge will prevent this from occurring.

Please keep this instruction manual for future reference



INSTALLATION INSTRUCTION

ATTENTION!

We strongly recommend the installation of the pipes and electrical connections should be made by a qualified engineer or similarly qualified professional.

WARNING:

Electrical Shock Hazard. Disconnect electrical power before installing dishwasher. Failure to do so can result in death or electrical shock

INSTALLATION PREPARATION

The installation position of dishwasher should be near the existing inlet and drain hoses and power cord.

One side of the cabinet sink should be chosen to facilitate the connection of drain hoses of the dishwasher.

NOTE:

Please check the accompanying installation accessories (fixing for aesthetic door panel).

Please keep this instruction manual for future reference



PLEASE CAREFULLY READ THE INSTALLATION INSTRUCTION

Illustrations of cabinet dimensions and installation position of the dishwasher

Preparations should be made before moving the dishwasher to the installation place.

1. Choose a place near the sink to facilitate the installation of inlet and drain hoses (see figure 1).
2. If dishwasher is installed at the corner of the cabinet, there should be some space (illustrated in figure 2) when the door is opened.

Figure 1
Cabinet dimensions
Less than 5mm
between the top
of dishwasher and
cabinet and the
outer door aligned
to cabinet.

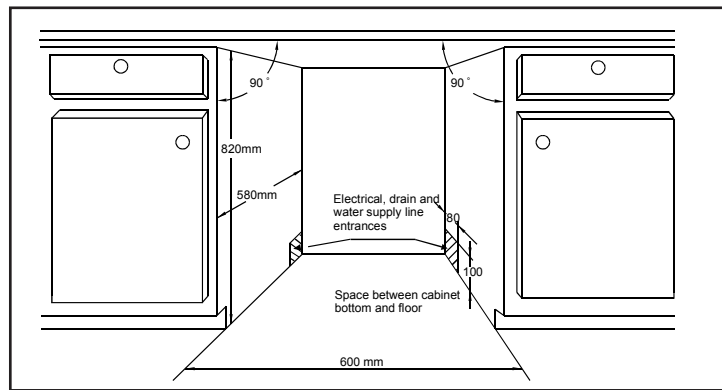
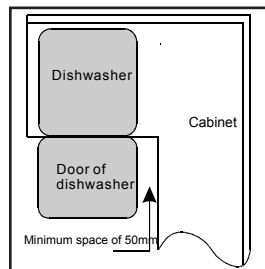

Figure 2
Minimum space when
the door is opened



Please keep this instruction manual for future reference

Instruction manual Di651 35





AESTHETIC DOOR PANEL DIMENSIONS AND INSTALLATION

The aesthetic door panel could be processed according to the Figure 3

Figure 3
The aesthetic door panel should be processed in accordance with the illustrated dimensions

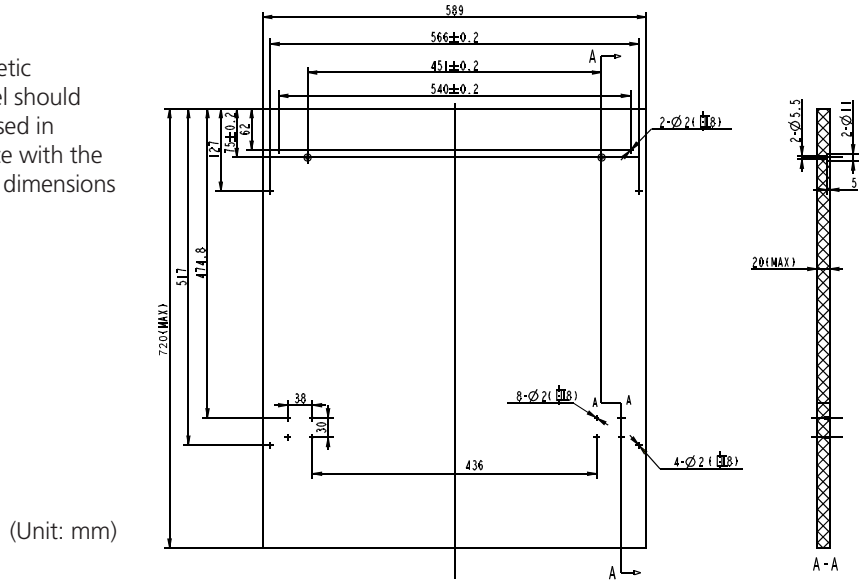

Please keep this instruction manual for future reference





Install the hook on the aesthetic door panel and put the hook into the slot of the outer door of dishwasher(see figure 4a). After positioning of the panel, fix the panel onto the outer door by screws and bolts(See figure 4b) .

Figure 4
Installation of
aesthetic panel

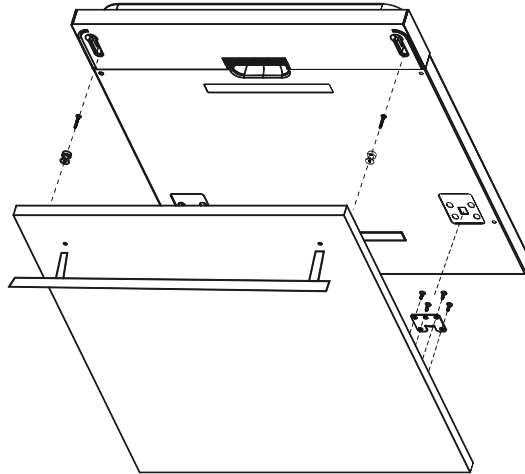
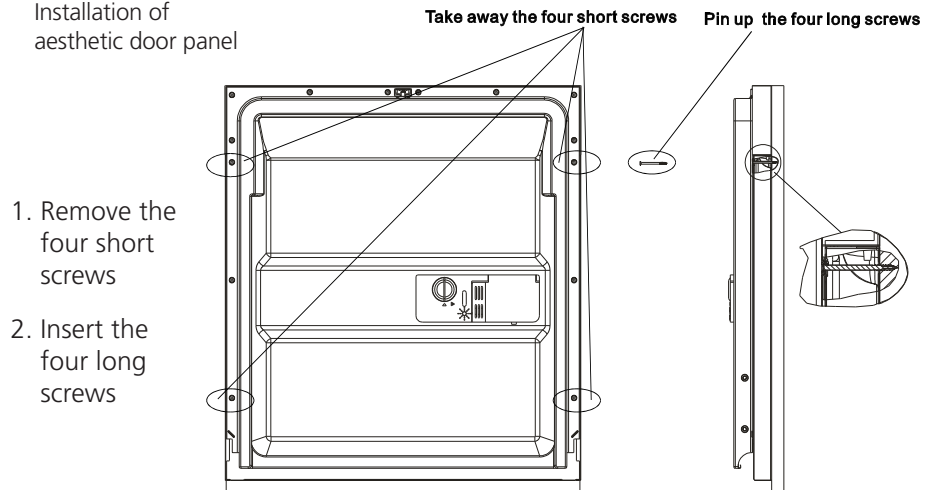

Figure 4
Installation of
aesthetic door panel



Please keep this instruction manual for future reference





TENSION ADJUSTMENT OF THE DOOR SPRING

The door springs are set at the factory to the proper tension for the outer door. When the aesthetic door panel is installed, you will have to adjust the door spring tension. Rotate the adjusting screw to drive the adjuster to strain or relax the steel cable (see figure 5).

Door spring tension is correct when the door remains horizontal in the fully opened position, yet rises to a close with the slight lift of a finger.

Figure 5
Tension adjustment
of the door spring

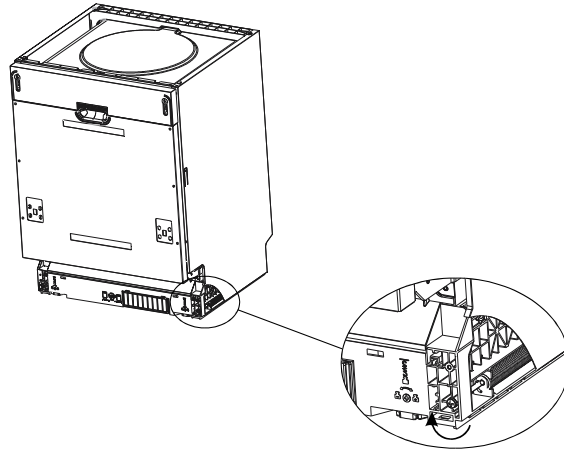

CONNECTION OF DRAIN HOSES

Insert the drain hose into a drain pipe with a minimum diameter of 40mm, or let it run into the sink, making sure to avoid bending or crimping it. The top of the hose must be less than 1000mm.

 PLEASE FIX THE DRAIN HOSE EITHER WAY OF A, B

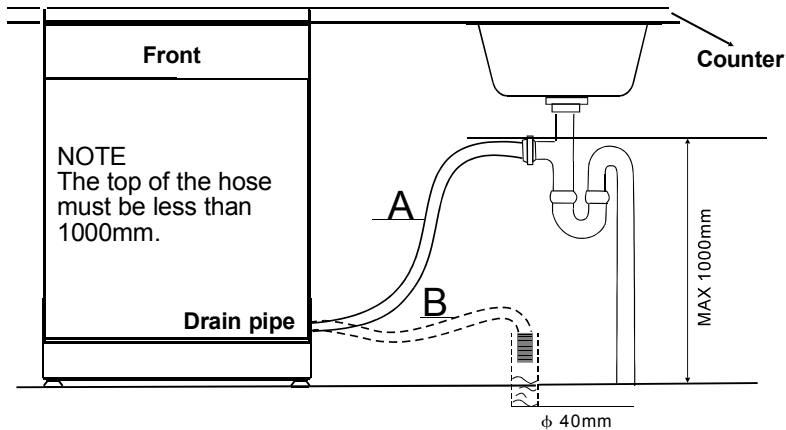

Please keep this instruction manual for future reference





DISHWASHER INSTALLATION STEPS

1. Install the furniture door to the outer door of the dishwasher using the brackets provided. Refer to the template for positioning of the brackets.
2. Adjust the tension of the door springs by using an Allen key turning in a clockwise motion to tighten the left and right door springs. Failure to do this could cause damage to your dishwasher(2).
3. Connect the inlet hose to the cold water supply .
4. Connect the drain hose. Refer to diagram.(6)
5. Connect the power cord.
6. Affix the condensation strip under the work surface of cabinet. Please ensure the condensation strip is flush with edge of work surface. (3)
7. Place the dishwasher into position.(4)
8. Level the dishwasher. The rear foot can be adjusted from the front of the dishwasher by turning the Allen screw in the middle of the base of dishwasher use an Allen key (5A). To adjust the front feet, use a flat screw driver and turn the front feet until the dishwasher is level (5B). 9 The dishwasher must be secured in place. There are two ways to do this:
 - A. Normal work surface:Put the installation hook into the slot of the side plane and secure it to the work surface with the wood screws (6).
 - B. Marble or granite work top:Fix the side with Screw. (7).

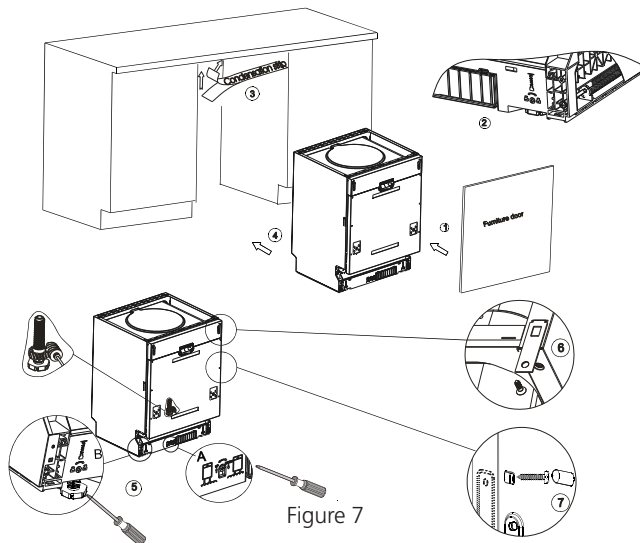

Figure 7

Please keep this instruction manual for future reference



Dishwasher must be level for proper dish rack operation and wash performance.

1. Place a spirit level on door and rack track inside the dishwasher as shown to check that the dishwasher is level.
2. level the dishwasher by adjusting the three leveling legs individually.
3. When leveling the dishwasher, please pay attention not to let the dishwasher tip over.

Figure 8
Illustration of
feet adjustment

NOTE:
The maximum
adjustment height
of the feet is 50 mm

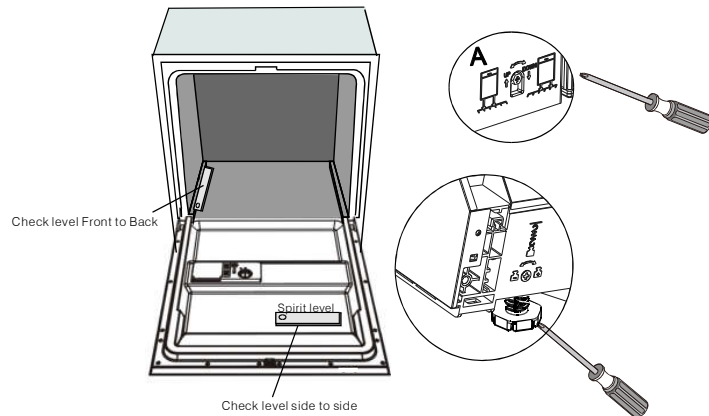

Please keep this instruction manual for future reference





ELECTRICAL CONNECTION

WARNING:

For personal safety:

- Do not use an extension cord or an adapter plug with this appliance.
- Do not, under any circumstances, cut or remove the earthing connection from the power cord.

ELECTRICAL REQUIREMENTS

Please look at the rating label to know the rating voltage and connect the dishwasher to the appropriate power supply. Use the required 10 amp fuse, time delay fuse or circuit breaker recommended and provide separate circuit serving only this appliance.

ELECTRICAL CONNECTION

Ensure the voltage and frequency of the power being corresponds to those on the rating label. Only insert the plug into an electrical socket which is earthed properly. If the electrical socket to which the appliance must be connected is not appropriate for the plug , replace the socket, rather than using a adapter as they could cause overheating and burns.

GROUNDING INSTRUCTIONS

This appliance must be earthed. In the event of a malfunction or breakdown, earthing will reduce the risk of electric shock by providing a path of least resistance for the electric current. This appliance is equipped with a cord having an equipment-earthing conductor and an earthing plug. The plug must be plugged into an appropriate outlet that is installed and earthed in accordance with all local standards and requirements.

WARNING:

Improper connection of the equipmentgrounding conductor can result in the risk of an electric shock. Check with a qualified electrician or service representative if you are in doubt whether the appliance is properly grounded. Do not modify the plug provided with the appliance; If it is not fit for the outlet. Have a proper outlet installed by a qualified electrician.

Please keep this instruction manual for future reference



CONNECT THE AQUASTOP SAFETY SUPPLY HOSE

The appliance must be connected to the water mains using new hose-sets. The old hose-sets should not be reused. Water pressure must be between 0,04 MPa and 1 MPa. If the pressure is below the minimum consult our Service Department for advice.

- Pull The safety supply hoses completely out from storage compartment located at rear of dishwasher.
- Tighter the screws of the safety supply hose to the faucet with thread $\frac{3}{4}$ inch.
- Turn water fully on before starting the dishwasher.

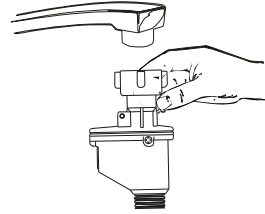

ABOUT THE SAFETY SUPPLY HOSE

The safety supply hose consists of the double walls. The hose's system guarantees its intervention by blocking the flow of water in case of the supply hose breaking and when the air space between the supply hose itself and the outer corrugated hose is full of water.

WARNING:

Ensure the Aquastop safety supply unit is in a vertical position once installed.

HOW TO CONNECT THE SAFETY SUPPLY HOSE

- Turn off the water.
- Unscrew The safety 2 supply hose from the faucet.

COLD WATER CONNECTION

Connect the cold water supply hose to a threaded $\frac{3}{4}$ (inch) connector and make sure that it is fastened tightly in place. If the water pipes are new or have not been used for an extended period of time, let the water run to make sure that the water is clear and free of impurities. If this precaution is not taken, there is a risk that the water inlet can get blocked and damage the appliance.

WARNING:

Please close the hydrant after using.

ATTENTION After installation, please make sure to keep this manual
The content of this manual is very helpful to the users

Please keep this instruction manual for future reference





POSITIONING THE APPLIANCE

Position the appliance in the desired location. The back should rest against the wall behind it, and the sides, along the adjacent cabinets or walls. The dishwasher is equipped with water supply and drain hoses that can be positioned either to the right or the left sides to facilitate proper installation.

HOW TO DRAIN EXCESS WATER FROM HOSES

If the sink waste is more than 1000mm from the floor, the excess water in hoses cannot be drained directly into the sink. It will be necessary to drain excess water from hoses into a bowl or suitable container that is held outside and lower than the sink.

WATER OUTLET

Connect the water drain hose. The drain hose must be correctly fitted to avoid water leaks. Ensure that the water inlet hose is not kinked or squashed.

EXTENSION HOSE

If you need a drain hose extension, make sure to use a similar drain hose. It must be no longer than 4 metres; otherwise the cleaning effectiveness of the dishwasher could be reduced.

SYPHON CONNECTION

Insert the drain hose into a drain pipe with a minimum diameter of 40mm, or let it run into the sink, making sure to avoid bending or crimping it. The top of the hose must be less than 1000mm from the floor.

START THE DISHWASHER

The following things should be checked before starting the dishwasher.

1. The dishwasher is level and fixed properly
2. The inlet valve is open
3. There is no leakage at the connection points
4. The wires are tightly connected
5. The power is switched on
6. The inlet and drain hoses are not knotted
7. All packing materials and printings should be taken out from the dishwasher

Please keep this instruction manual for future reference

TROUBLE SHOOTING TIPS

BEFORE CALLING FOR SERVICE

Type	Problem	Possible Causes	What to do	
Technical problems	Dishwasher doesn't start	Fuse blown, or the circuit breaker acted	Replace fuse or reset circuit breaker. Remove any other appliances sharing the same circuit with the dishwasher	
		Power supply is not turned on	Make sure the dishwasher is turned on and the door is closed securely. Make sure the power cord is properly plugged into the wall socket.	
		Water pressure is low	Check that the water supply is connected properly and the water is turned on.	
		Door of dishwasher not properly closed.	Make sure to close the door properly and latch it.	
	Water not pumped from dishwasher	Kink in drain hose	Check drain hose.	
		Filter clogged	Check coarse filter (see section titled) the " Cleaning The Filter "	
Kitchen sink clogged		Check the kitchen sink to make sure it is draining well. If the problem is the kitchen sink not draining, you may need a plumber.		
General problems	Suds in the tub	Improper detergent	Use only the special dishwasher detergent to avoid suds. If this occurs, open the dishwasher and let suds evaporate. Add 1 gallon of cold water to the tub. Close and latch the dishwasher, then select any cycle. Dishwasher will drain out the water at the first step. Open the door after draining to stop and check if the suds have disappeared. Repeat if necessary.	
		Spilled rinse-aid	Always wipe up rinse-aid spills immediately	
	Stained tub interior	Detergent with colourant was used	Make sure that the detergent is the one without colourant.	
	White film on inside surface	Hard water minerals	To clean the interior, use a damp sponge with dishwasher detergent and wear rubber gloves. Never use any other cleaner than dishwasher detergent for the risk of foaming or suds.	
	There are rust stains on cutlery	The affected items are not corrosion resistant. A programme was not run after dishwasher salt was added. Traces of salt have gotten into the wash cycle.		Always run the quick wash programme . without any crockery in the dishwasher and without selecting the Turbo function (if present), after adding dishwasher salt.
		The lid of the softer is loose		Check the lip .Ensure the fix is fine.

Please keep this instruction manual for future reference



Type	Problem	Possible Causes	What to do
Noise	Knocking noise in the wash cabinet	A spray arm is knocking against an item in a basket	Interrupt the programme, and rearrange the items which are obstructing the spray arm.
	Rattling noise in the wash cabinet	Items of crockery are loose in the wash cabinet	Interrupt the programme, and rearrange the items of crockery.
	Knocking noise in the water piped	This may be caused by on-site installation or the cross-section of the piping	This has no influence on the dishwasher function. If in doubt, contact a suitably qualified plumber.
Unsatisfactory washing results	The dishes are not clean	The dishes were not loaded correctly	See notes in "Loading the Dishwasher Baskets".
		The programme was not powerful enough	Select a more intensive programme. See "Wash Cycle Table".
		Not enough detergent was dispensed	Use more detergent, or change your detergent.
		Items are blocking the path of spray arms	Rearrange the items so that the spray can rotate freely.
		The filter combination in the base of wash cabinet is not clean or is not correctly fitted. This may cause the spray arm jets to get blocked.	Clean and/or fit the filter combination correctly. Clean the spray arm jets. See "Cleaning the Spray Arms".
	Cloudiness on glassware	Combination of soft water and too much detergent.	Use less detergent if you have soft water and select a shortest cycle to wash the glassware and to get them clean.
	Black or grey marks on dishes	Aluminum utensils have rubbed against dishes.	Use a mild abrasive cleaner to eliminate those marks.
Detergent left in dispenser cups	Dishes block detergent cups.	Re-loading the dishes properly	

Please keep this instruction manual for future reference

Type	Problem	Possible Causes	What to do
Unsatisfactory drying results	The dishes are not drying	Improper loading	Load the dishwasher as suggested in the directions.
		Too little rinse-aid	Increase the amount of rinse-aid/refill the rinse-aid dispenser.
		Dishes are removed too soon	Empty the lower basket first and then the upper one. This will avoid water dripping from the upper Basket onto the dishes in the lower one.
		Wrong program has been selected	In short program the washing temperature is lower. This also lowers cleaning performance. Choose a program with a long washing time.
		Use of cutlery with a low-quality coating	Water drainage is more difficult with these items. Cutlery or dishes of this type are not suitable for washing in the dishwasher.

ERROR CODES

When some malfunctions occur, the appliance will display error codes to warn you:

Codes	Meanings	Possible Causes
E1	Longer inlet time.	Faucets is not opened, or water intake is restricted, or water pressure is too low.
E4	Overflow.	Some element of dishwasher leaks.
E8	Failure of orientation of distributary valve.	Open circuit or break of distributary valve.
E9	Button pressed for more than 30 seconds.	Water or object on the button. Clean off

WARNING:

- If overflow occurs, turn off the main water supply before calling a service.
- If there is water in the base pan because of an overflow or small leak, the water should be removed before restarting the dishwasher.

Please keep this instruction manual for future reference



TECHNICAL INFORMATION

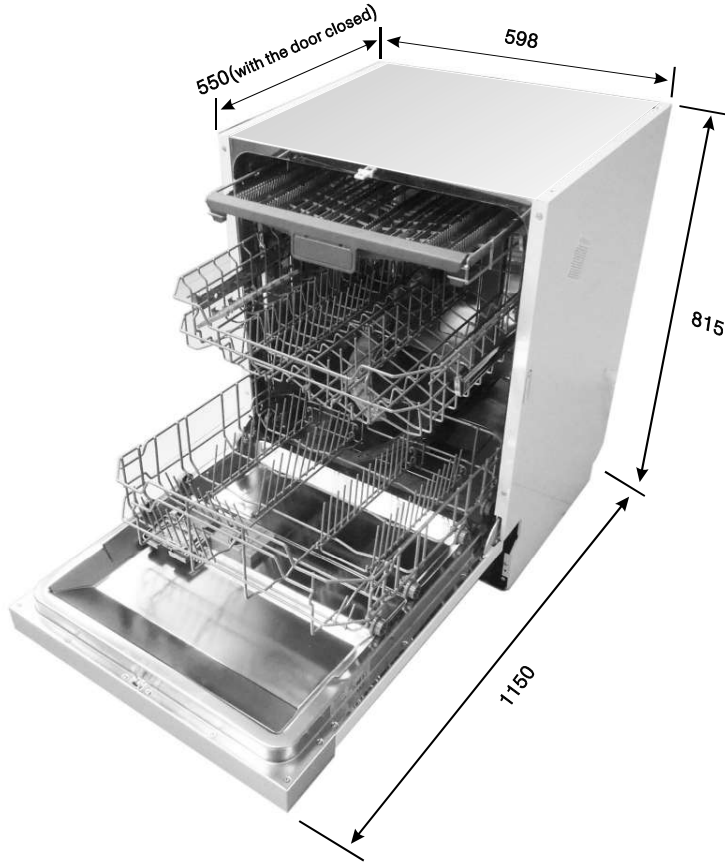

Height:	815mm
Width :	598 mm
Depth :	550mm(with the door closed)
Water pressure:	0.04-1.0MPa
Power supply:	see rating label
Capacity:	15 place settings

Please keep this instruction manual for future reference

Instruction manual Di651 47



TECHNICAL FICHE

Sheet of household dishwasher according to EU Directive 1059/2010:

Manufacturer	Caple
Type / Description	DI651
Standard place settings	15
Energy efficiency class 1	A+++
Annual energy consumption 2	241 kWh
Energy consumption of the standard cleaning cycle	0.84 kWh
Power consumption of off-mode	0.45 W
Power consumption of left-on mode	0.49 W
Annual water consumption 3	2800 liter
Drying efficiency class 4	A
Standard cleaning cycle 5	ECO 45°C
Program duration of the standard cleaning cycle	220 min
Noise level	40 dB(A) re 1 pW
Mounting	Build under
Could be built-in	Yes
Height	81.5 cm
Width	59.8 cm
Depth (with connectors)	55 cm
Power consumption	1930 W
Rated voltage / frequency	230 V~ / 50 Hz
Water pressure (flow pressure)	0.4-10 bar = 0.04-1 MPa

Please keep this instruction manual for future reference



NOTE:

- 1 A + + + (highest efficiency) to D (lowest efficiency)
- 2 Energy consumption "241" kWh per year, based on 280 standard cleaning cycles using cold water fill and the consumption of the low power modes. Actual energy consumption will depend on how the appliance is used.
- 3 Water consumption "2800" litres per year, based on 280 standard cleaning cycles. Actual water consumption will depend on how the appliance is used.
- 4 A (highest efficiency) to G (lowest efficiency)
- 5 This program is suitable for cleaning soiled normally soiled tableware and that it is the most efficient programme in terms of its combined energy and water consumption for that type of tableware.

The device meets the European standards and the directives in the current version at delivery (If the version number is not in conformity with the latest standards, please refer to the latest version number.):

- LVD 2014/35/EU
- EMC 2014/30/EU
- ERP 2009/125/EC

The above values have been measured in accordance with standards under specified operating conditions. Results may vary greatly according to quantity and pollution of the dishes, water hardness, amount of detergent, etc.

The manual is based on the European Union's standards and rules.

Please keep this instruction manual for future reference

Instruction manual Di651 49



Notes:

Please keep this instruction manual for future reference





Notes:

Please keep this instruction manual for future reference

Instruction manual Di651 51





Caple Service
Fourth Way
Avonmouth
Bristol
BS11 8DW

t: 0117 938 7420
e: service@caple.co.uk
www.caple.co.uk

Please keep this instruction manual for future reference