



# DI464

**Caple 45cm Fully Integrated Dishwasher**



**TECHNICAL INFORMATION**

# New product information sheet

**Product name:** Di464

**Description:** Slimline fully integrated dishwasher

**Product code:** Di464

Width 450mm

Performance

Energy class A

Wash class B

Drying performance A

4 Programmes:

*3 in 1 - 51 °C 150 minutes*

*intensive 55 °C 120 minutes*

*economy 50 °C 150 minutes*

*rapid 40°C 30 minutes*

Max. noise level 55dB

Energy consumption 0.74 kw/h

Water consumption (*economy*) 11L

Features

8 Place settings

3 Spray levels

Max. plate diameter 26cm

Stainless steel inner door and interior

White door top control panel

Titanium Grey baskets

Salt and Rinse aid warning light

Duration of longest cycle 160 minutes

Cold Water connection

Hidden heating element

Height adjustable upper basket

Easy clean filter system

3 Level water softening system

Water overflow protection system

Electrical connection

Voltage 230V

Rated load 1.93kW

Fuse rating 13A



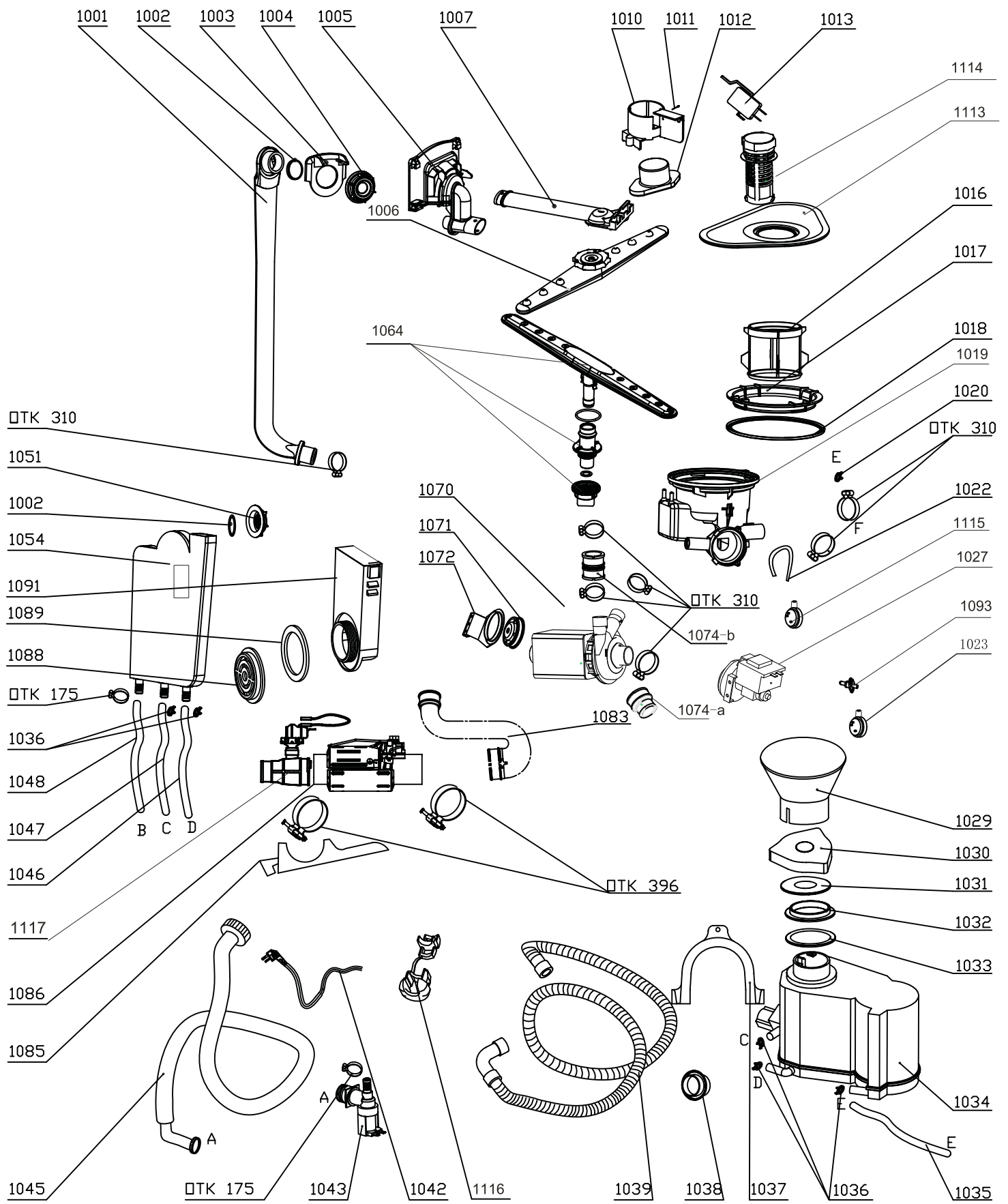

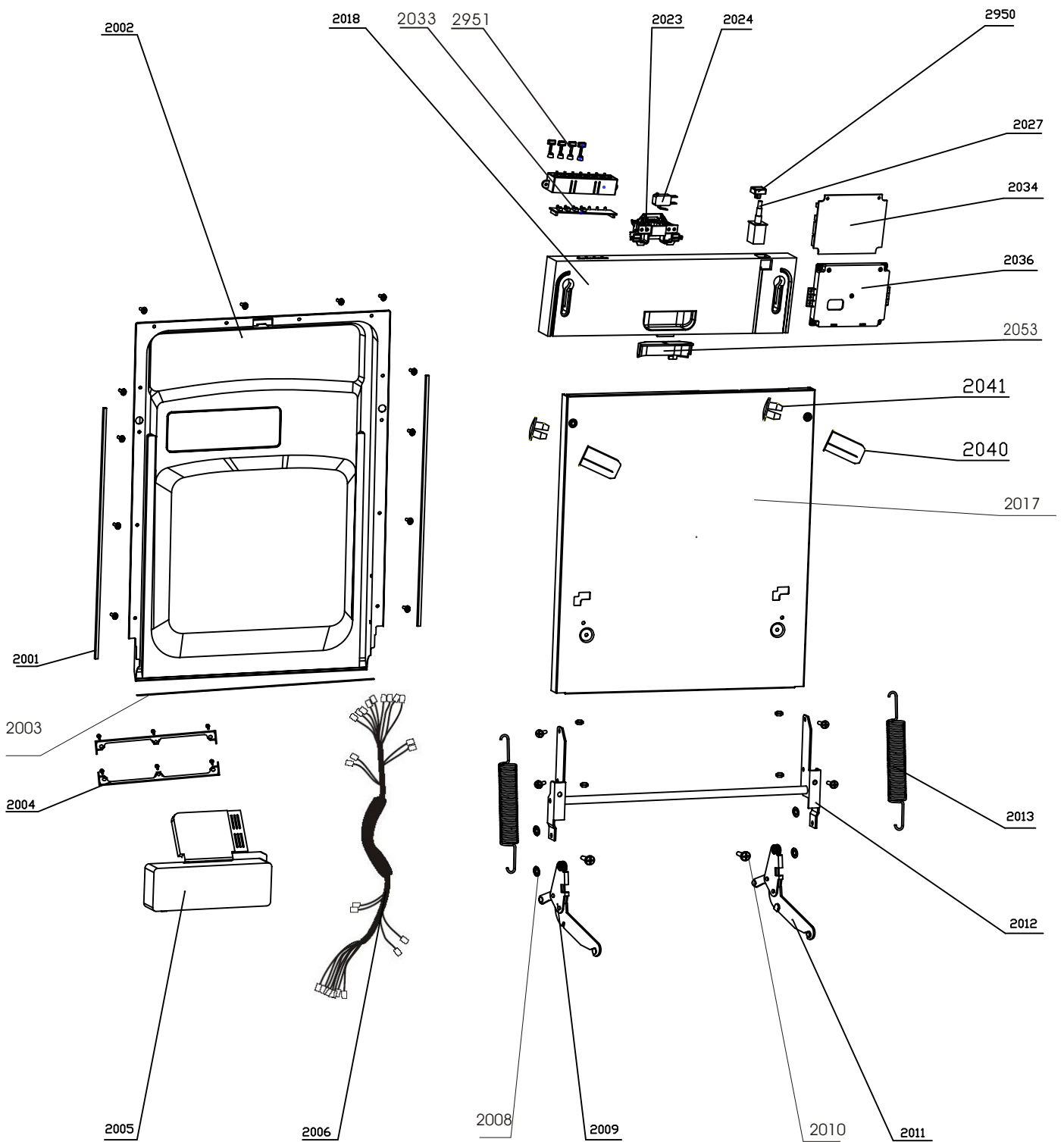

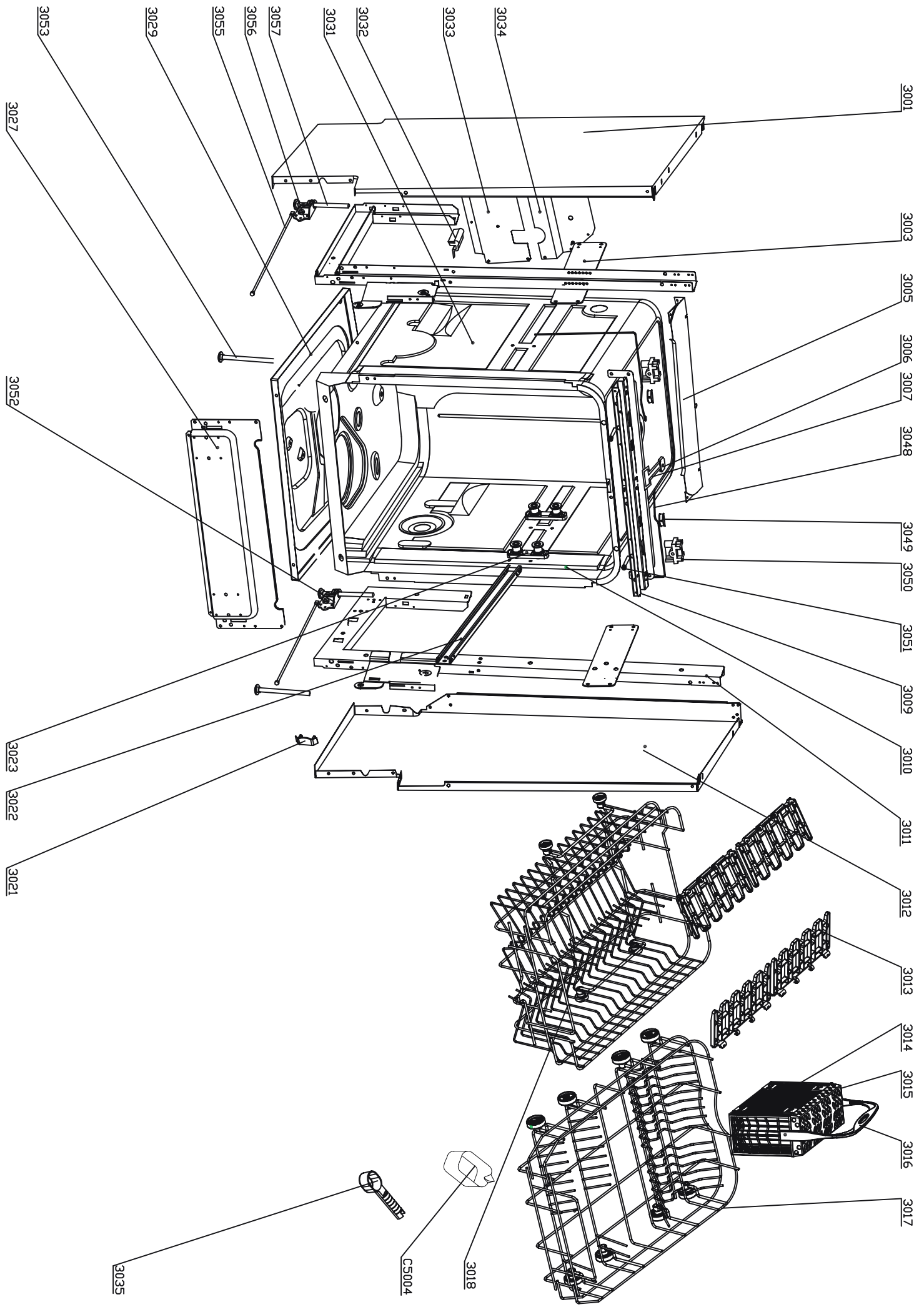



## DI464 - Caple 45cm Fully Integrated Dishwasher

Item	Part Code	Description	Qty
1001	673000900249	External pipe	1
1002	673001500005	O Ring I 31.5X3.55	2
1003	673001800364	Guide casing	1
1004	673001600021	External pipe nut	1
1005	673001900016	Water dispenser	1
1006	673000300050	Upper sprayer	1
1007	673000900195	Upper sprayer pipe	1
1010	673002300002	Float holder	1
1011	672000900012	Screw ST2.9x22	1
1012	673002300003	Float	1
1013	674000300060	Micro switch	1
1016	673002500047	Micro filter	1
1017	673001600022	Sump nut	1
1018	673001500016	Sump gasket	1
1019	673000700082	Sump	1
1020	672000700028	Clamp 12.7×1.8	1
1022	673000900160	PVC hose	1
1023	674000300075	Pressure switch	1
1027	674000600106	Drain pump	1
1029	673002200043	Salt filler	1
1030	673002800050	Softener cover assembly	1
1031	673001700053	Softener cover gasket	1
1032	673001600039	Softener nut	1
1033	673001700001	Softener gasket	1
1034	674000700021	Softener	1
1036	672000700029	Clamp 14.5×1.8	3
1037	673006200003	Drain hose hook	1
1038	673001500002	Drain hose holder	1
1039	673000900186	Drain hose	1
1042	674000000194	Power cord	1
1043	674000200002	Inlet valve	1
1045	673000900060	Inlet hose assembly	1
1046	673000900026	Regeneration hose	1
1048	673000900024	Inlet hose of air breather	1
1051	673001600025	Air breather nut	1



## DI464 - Caple 45cm Fully Integrated Dishwasher

Item	Part Code	Description	Qty
1054	673002700001	Air breather assembly	1
1064	672000600015	Lower sprayer	1
1070	674000600047	Washing pump	1
1083	673000900045	Bend connect hose	1
1085	673001400025	Heating element support	1
1086	674001100039	Heating elements	1
1088	673001600024	Water inlet nut	1
1089	673001500019	Water inlet gasket	1
1091	673002600035	Water inlet	1
1093	674000900038	Sensing device	1
1113	673002500048	plane filter	1
1114	673001300137	Scran collection	1
1115	674000300079	Pressure switch 140/120	1
1116	673001400083	power cord clasper	1
1117	674000300067	pressure switch assembly for heating elements	1
2001	673002000084	Door edge guard piece	2
2002	672002200137	Inner door	1
2003	673001700081	Door bottom gasket	1
2004	672001700002	Dispenser bracket	2
2005	674000800032	Dispenser	1
2006	674000100593	Wiring harness	1
2008	672000500006	Ring $\Phi 6$	4
2009	672001300029	Left hinge	1
2010	672001200012	Joint pin	2
2011	672001300030	Right hinge	1
2012	672001300023	Door gemel assembly	1
2013	672000100004	Door spring	2
2017	672001800337	Outer door	1
2018	673000403803	control panel	1
2023	673001800513	Handle assembly	1
2024	674000300069	Micro switch	1
2027	674000300065	Power switch	1
2033	673002400101	lamp-chimney A	1
2034	674001020464	Control board	1
2036	673002400095	Control board box	1



## DI464 - Caple 45cm Fully Integrated Dishwasher

Item	Part Code	Description	Qty
2040	673001800018	Screw sleeve	2
2041	673000700005	Sleeve cover	2
2053	673002800041	Panel cover	1
2950	673000801091	Power button	1
2951	673000801588	program button	4
3001	672001600212	Left side panel	1
3003	672002100058	Left frame	1
3005	672001500003	Upper rear crosspiece	1
3006	673001300061	door clamp	1
3007	672001400039	Door lock	1
3009	672001500247	Upper front crosspiece	1
3010	673001700056	Tank gasket	1
3011	672002100057	Upright right assembly	1
3012	672001600211	Right panel	1
3013	673001300102	Upper basket cup holder	4
3014+3015+3016	673002200080	Cutlery basket	1
3017	672000800188	Lower basket	1
3018	672000800156	Upper basket	1
3021	673001300044	Rail block	2
3022	672001700005	Rail	1
3023	673001400056	Rail support assembly	4
3027	672001500292	Lower front crosspiece	1
3029	672002000065	Base board	1
3031	672001901139	Tank	1
3032	673001700010	Tank band bracing block	2
3033	672001500200	Lower rear crosspiece	1
3034	672001500114	Middle rear crosspiece	1
3035	673002200079	Measurable spoon	1
3048	672001100004	Adjust steel rope	2
3049	672002300002	Adjust nut	2
3050	673001300012	Top board hook	2
3051	672001100003	Adjust screw	2
3052	673001400146	Right adjuster holder assembly	1
3053	672001400036	Front foot	2
3055	672001100002	Adjustable pole	2



## DI464 - Caple 45cm Fully Integrated Dishwasher

Item	Part Code	Description	Qty
3056	673001400145	Left adjuster holder assembly	1
3057	672001400037	Back foot	2
1035+1047	673000900224	Softener pipe	2
1071+1072	672000200054	Washing motor support	1
1074-a	673000900140	Connect hose a	1
1074-b	673000900182	Connect hose b	1
C5004	673006200004	Rinsing agent cup	1
OTK 175	672000700004	OTK 175	2
OTK 286	672000700003	OTK 286	1
OTK 310	672000700001	OTK 310	5
OTK 396	672000700007	OTK 396	3

# Dishwasher Installation and Maintenance Instructions

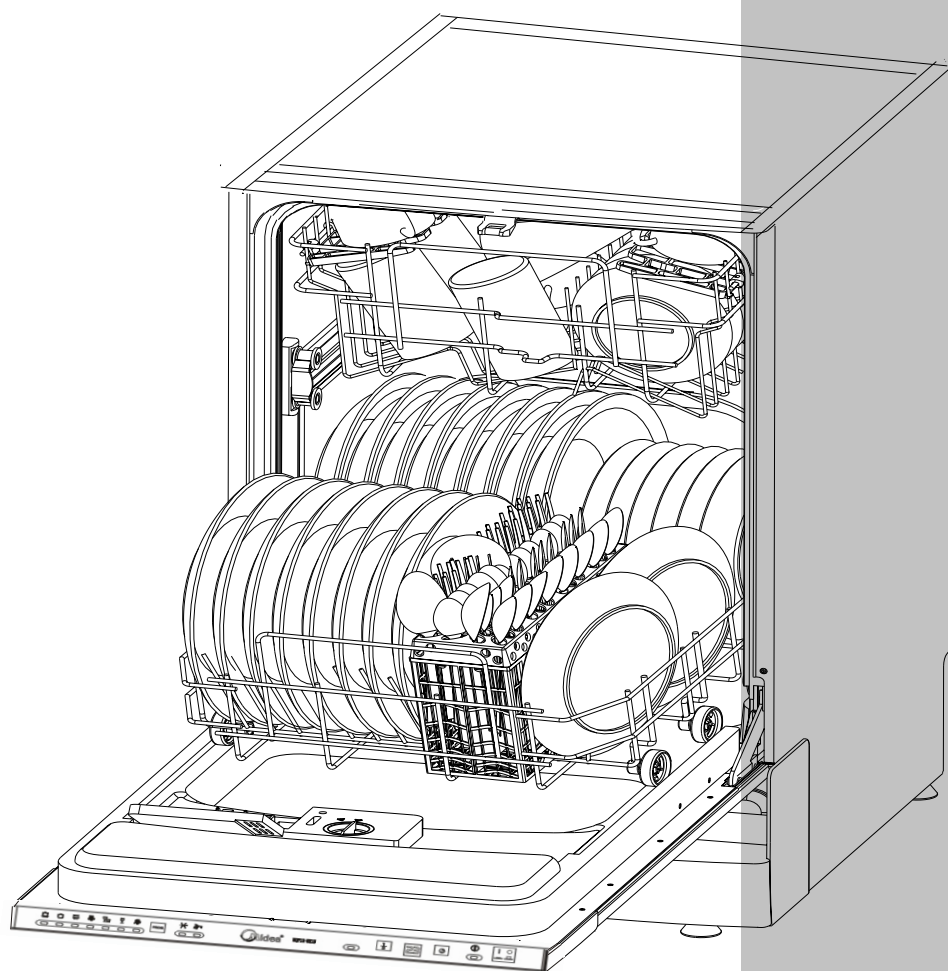

Shunde Midea Dishwasher Manufacturing Co.,Ltd.

# Content List

Chapter I	Installation	1
1.1	Safety Instruction	1
1.2	Installation Instruction	2
Chapter II	Maintenance	3
2.1	Foreword	3
2.2	Troubleshooting	3
2.3	Note	6

---

## Chapter I Installation

### 1.1 Safety Instruction

After unpacking, the appliance should be checked to see if there is any damage to it.

The dishwasher is intended to wash dishes and plates by adults.

When using the dishwasher, some basic principals should be followed:

- 1) Extended power cord and adaptor should not be used.
- 2) The power cord should not be too long or knotted.
- 3) Switch off the power before making any repair of the dishwasher.

Children should be kept away from the detergent and the opened dishwasher.

Then dishwasher should not be installed in an unsheltered place or exposed to the rain or other natural environment.

Never touch the heating element during or immediately after use.

The dishwasher should not be lean on or sit on when it is open, otherwise it will be overturned.

If the dishwasher malfunctions, turn off the water inlet and cut off the power before you read the instruction of Chapter II. If the problems cannot be solved by yourself, please contact the professional technicians.

The dishwasher could not be repaired by unprofessional personnel with non-original spare parts. It is recommended that if the dishwasher will not be used for a long time, it should be cut off the water inlet, remove the plug and keep the door of dishwasher ajar.

## 1.2 Installation Instruction

---

### Unpacking

- 1) Removing the packing accessories, please pay attention that the plastic bag should be out of the reach of children.
- 2) Open the door of the dishwasher to check the baskets are placed in the proper place (manufactures may fix the baskets by some simple ways for the sake of safety).

### Locate the dishwasher

- 1) The dishwasher should be kept away from heating resources and not be exposed to the sun to prevent its coating from fading or falling off.
- 2) The back of the dishwasher should rest against the wall behind it and the sides, along the adjacent cabinets or wall. The water supply and drain hose of the dishwasher could be positioned to the right of the left to facilitate proper installation.
- 3) The dishwasher should be built in the cabinet and fixed it on the cabinet by two screw.

### Installation steps

- 1) Install the aesthetic pannel on the outer door of the dishwasher.
- 2) Adjust the tension of door spring.
- 3) level the dishwahser and touch the cabinet by adjusting the four leveling legs individually.
- 4) Connect the inlet, and drain hoses, and power cord .
- 5) pushing the dishwasher into the cabinet.
- 6) fixing the dishwasher into the cabinet by two countersunk head screw.

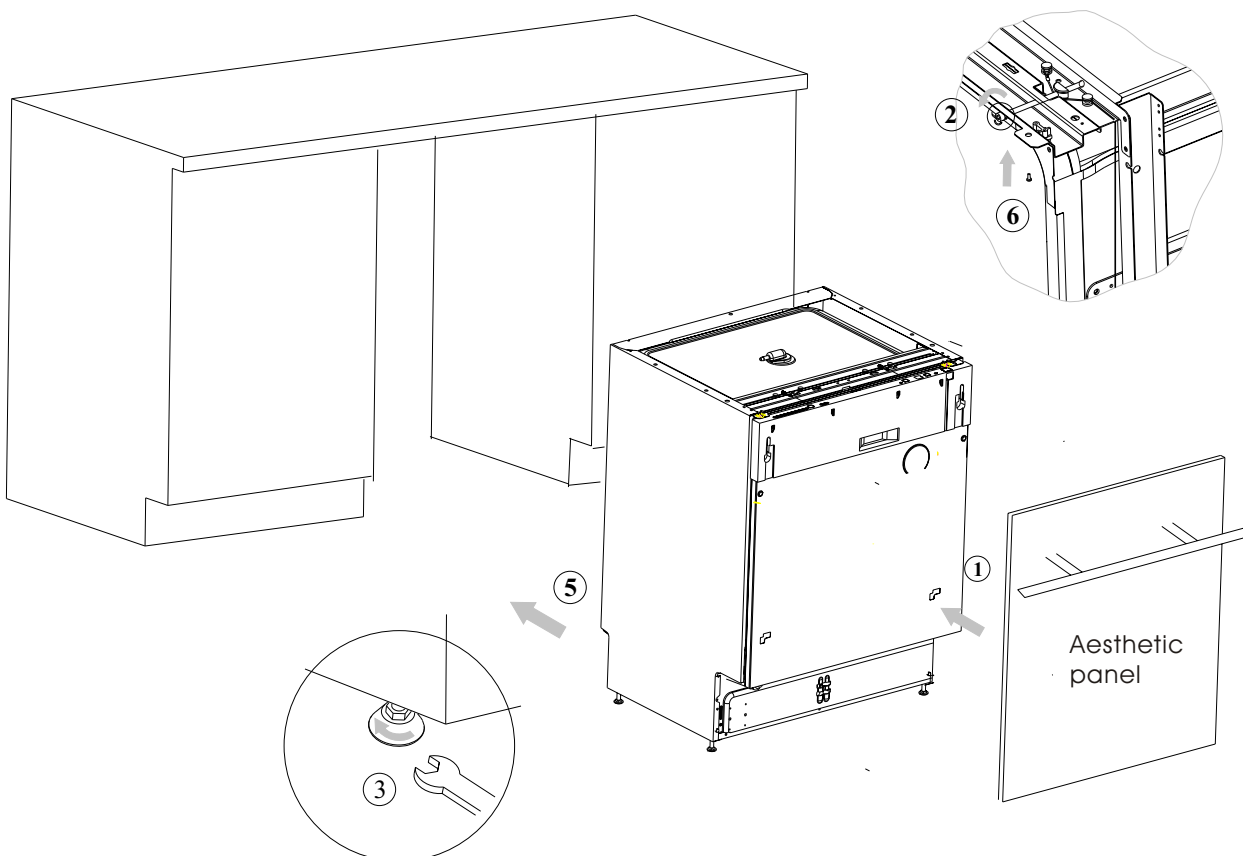

Installation steps

When you want more particular content about installation, please to see the installation manual we edited.

## Chapter II Maintenance

### 2.1 Foreword

Before any repair service, you should check:

- a) Whether the dishwasher is properly installed according to the installation manual.
- b) Whether the damaged components have been repaired or not.
- c) Whether the charging hose and the drain hose are properly installed.
- d) Whether the dishwasher is level or not.
- e) Whether there is salt in the water softener.
- f) Whether there is rinse agent in the dispenser.

The circuit board is the centrum of the whole control system of the dishwasher. When dishwasher is washing bowels, All information come to the circuit, then the circuit delivery various dictate to every department of dishwasher to keep the dishwasher moving. the dishwasher move with a arranged program. If you know the program and structure of the dishwasher, you will easy find out all kind of trouble of dishwasher.

### 2.2 Troubleshooting

Questions put forward by users	By misusage of users	The problems of the dishwasher itself
The dishwasher does not start	<ul style="list-style-type: none"> <li>* Something wrong with the socket</li> <li>* No water (the water valve is closed)</li> <li>* Improper electrical connection</li> <li>* The door is not properly closed</li> <li>* Incorrect position of charging hose</li> </ul>	<ul style="list-style-type: none"> <li>* Power cord</li> <li>* "ON/OFF" switch</li> <li>* Door switch</li> <li>* Water inlet valve</li> <li>* Pressure switch</li> <li>* Aqua-stop switch</li> </ul>
Water floods in the dishwasher		<ul style="list-style-type: none"> <li>* Air leakage of the chamber</li> <li>* The hose of pressure switch</li> <li>* Pressure switch</li> <li>* Water inlet valve</li> </ul>
The dishwasher does not heat		<ul style="list-style-type: none"> <li>* Malfunction of heating element</li> <li>* The circuit is not properly contacted</li> <li>* Malfunction of the thermocouple</li> </ul>
No water comes into the dishwasher	<ul style="list-style-type: none"> <li>* Water supply is cut off</li> <li>* The filter of the water inlet valve is clogged.</li> </ul>	<ul style="list-style-type: none"> <li>* Connection to the inlet valve is broken or damaged.</li> <li>* Electrical connection is cut off.</li> <li>* Pressure switch</li> <li>* Aqua-stop switch</li> <li>* The softener is blocked.</li> </ul>

The dishes are not clean enough after washing	<ul style="list-style-type: none"> <li>* The filter is clogged.</li> <li>* Unqualified detergent or the dosage in the container is not correct.</li> <li>* No salt in the softener</li> <li>* No rinse agent</li> <li>* Incorrect loading of dishes *</li> <li>Something wrong with the drain pipe in the home</li> </ul>	<ul style="list-style-type: none"> <li>* Flow and pressure of washing pump</li> <li>* Detergent is not released from dispenser</li> <li>* Heating element is not working</li> <li>* The nozzle is blocked by food particles</li> <li>* No water coming into the dishwasher</li> <li>* The dispenser malfunctions</li> <li>* Sth wrong with the pressure switch and the charging water is not enough</li> </ul>
The dishwasher couldn't wash properly	<ul style="list-style-type: none"> <li>* Wrong loading position of the dishes.</li> </ul>	<ul style="list-style-type: none"> <li>* Short circuit of startup capacitance</li> <li>* Washing motor is blocked or burnt</li> <li>* Pressure switch</li> <li>* Malfunction of the circuit board</li> </ul>
The dishes are wet	<ul style="list-style-type: none"> <li>* The customer chose the program without drying performance</li> </ul>	<ul style="list-style-type: none"> <li>* Thermocouple doesn't work properly</li> <li>* Heating element is malfunctions</li> <li>* Something is wrong with the circuit board</li> </ul>
The dishes are not completely dried	<ul style="list-style-type: none"> <li>* Incorrect loading of the dishes</li> <li>* Earlier opening of the door</li> <li>* No rinse agent or the dosage is not enough</li> <li>* Incorrect selecting the program</li> </ul>	<ul style="list-style-type: none"> <li>* The passage of the breather is blocked</li> <li>* The drain pump does not drain out water</li> <li>* Detergent is not released from the dispenser</li> </ul>
Too much noise	<ul style="list-style-type: none"> <li>* Incorrect loading of dishes</li> </ul>	<ul style="list-style-type: none"> <li>* Noise from washing pump</li> <li>* Noise from drain pump</li> <li>* Noise from water inlet valve</li> <li>* Noise from breather</li> </ul>
Feeling like to be electrically shocked by the dishwasher	<ul style="list-style-type: none"> <li>* The electrical wire in the house is not earthed.</li> </ul>	<ul style="list-style-type: none"> <li>* Connection of the terminal box</li> <li>* Grounding of the heating element</li> <li>* Circuit and its components</li> </ul>
Water leakage and flood of the dishwasher	<ul style="list-style-type: none"> <li>* Too much detergent</li> <li>* Using the detergent with foam, which is not the one intended for using with dishwasher</li> </ul>	<ul style="list-style-type: none"> <li>* Pressure switch</li> <li>* Door gasket</li> <li>* Water leakage of pipes, gaskets and bolts</li> <li>* Drain hose</li> <li>* Washing pump</li> <li>* Softener valve</li> <li>* Softener</li> <li>* Breather</li> </ul>

Odd smell in the dishwasher	<ul style="list-style-type: none"> <li>* Food particles on the tub bottom</li> <li>* Food particles on the heating element</li> <li>* Plastic dishes used in the dishwasher</li> </ul>	<ul style="list-style-type: none"> <li>* The water temperature is too high when drying (overheating)</li> <li>* Thermocouple doesn't work properly</li> </ul>
Long time for a washing cycle	<ul style="list-style-type: none"> <li>* Inlet pressure is too low</li> <li>* Incorrect location of charging and drain hoses or they are bent</li> <li>* The filter of inlet valve is blocked</li> </ul>	<ul style="list-style-type: none"> <li>* The drain hose is crimped or bent</li> <li>* Malfunction of the drain pump</li> <li>* Infill of the inlet valve is blocked</li> <li>* Clog of the softener</li> <li>* Malfunction of the thermocouple</li> </ul>
The detergent could not be released from the dispenser	<ul style="list-style-type: none"> <li>* Bad quality of the detergent</li> <li>* The detergent is damped into blocks</li> <li>* Wrong location of the dishes</li> </ul>	<ul style="list-style-type: none"> <li>* The plug of detergent container could not be opened.</li> <li>* No action of the solenoid valve of electric feeding dispenser.</li> <li>* Malfunction of the electric circuit</li> <li>* Malfunction of the thermocouple</li> </ul>
Dishwasher stops when cycling		<ul style="list-style-type: none"> <li>* Electric circuit</li> <li>* Door switch</li> <li>* Pressure switch</li> <li>* The circuit board</li> <li>* Power switch</li> </ul>
Dishes are damaged or glassware is broken	<ul style="list-style-type: none"> <li>* The dishes are not suitable for washing in the dishwasher</li> <li>* The dishes are overturned</li> <li>* The washing temperature is not suitable for glassware</li> </ul>	<ul style="list-style-type: none"> <li>* Basket is damaged</li> <li>* Malfunction of the thermocouple</li> </ul>
The dishwasher does not drain	<ul style="list-style-type: none"> <li>* Block of drain hose</li> </ul>	<ul style="list-style-type: none"> <li>* Malfunction of drain pump</li> <li>* Improper connection of electric circuit</li> <li>* Malfunction of the thermocouple</li> </ul>
Lime deposits form on the dishes	<ul style="list-style-type: none"> <li>* Too much detergent</li> </ul>	<ul style="list-style-type: none"> <li>* Reduce the dosage</li> </ul>
The dishes look greasy and a blue film forms on them sometimes	<ul style="list-style-type: none"> <li>* Too much rinse agent</li> </ul>	<ul style="list-style-type: none"> <li>* Reduce the dosage</li> </ul>
Dirty spots on the surface of the dishwasher	<ul style="list-style-type: none"> <li>* The detergent sticks to the damp surface</li> </ul>	<ul style="list-style-type: none"> <li>* Use the detergent according to the user's manual</li> <li>* The detergent should not be spilled on the surface of the dishwasher</li> </ul>
Strange color of the surface of the washed dishes	<ul style="list-style-type: none"> <li>* The salt is not intended to use in the dishwasher.</li> </ul>	<ul style="list-style-type: none"> <li>* The influence of salt on the resin</li> </ul>

### 2.3 Notes

1. According to the program requiring, when the dishwasher is heated to a certain temperature, the circuit board will shut off the electric supply to the electrothermal element.
2. Aqua-stop device: start up the drain pump and make the dishwasher stop its running.
3. The 90°C thermostat is closed under normal condition. When the dishwasher is heated to a certain temperature, the thermostat will open to shut off the electric supply to the electrothermal elements.

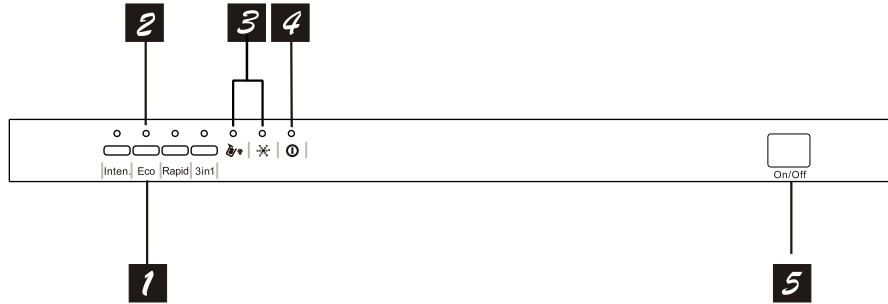

**1** Program button :To select washing program when press the button.

**2** Program indicator light: when you select washing program, the correspond light will display.

**3** Salt and Rinse Aid Warning Light: To come on when the softener or dispenser needs to be refilled.

**4** Power on light: To come on when Power ON/OFF button is pressed down.

**5** ON/OFF Button: To turn on/off the power supply.

## ERROR CODES

Codes	Meanings	Possible Causes
<i>The 3 in 1 light flicker fleetly</i>	Longer inlet time.	Faucets is not opened.
<i>The rapid light flicker fleetly</i>	Longer draining time.	The installation position of the drain pipe is too high.
<i>The economy light flicker fleetly</i>	Overfilled.	Too much inlet water. .

220 ~ 240V/50Hz

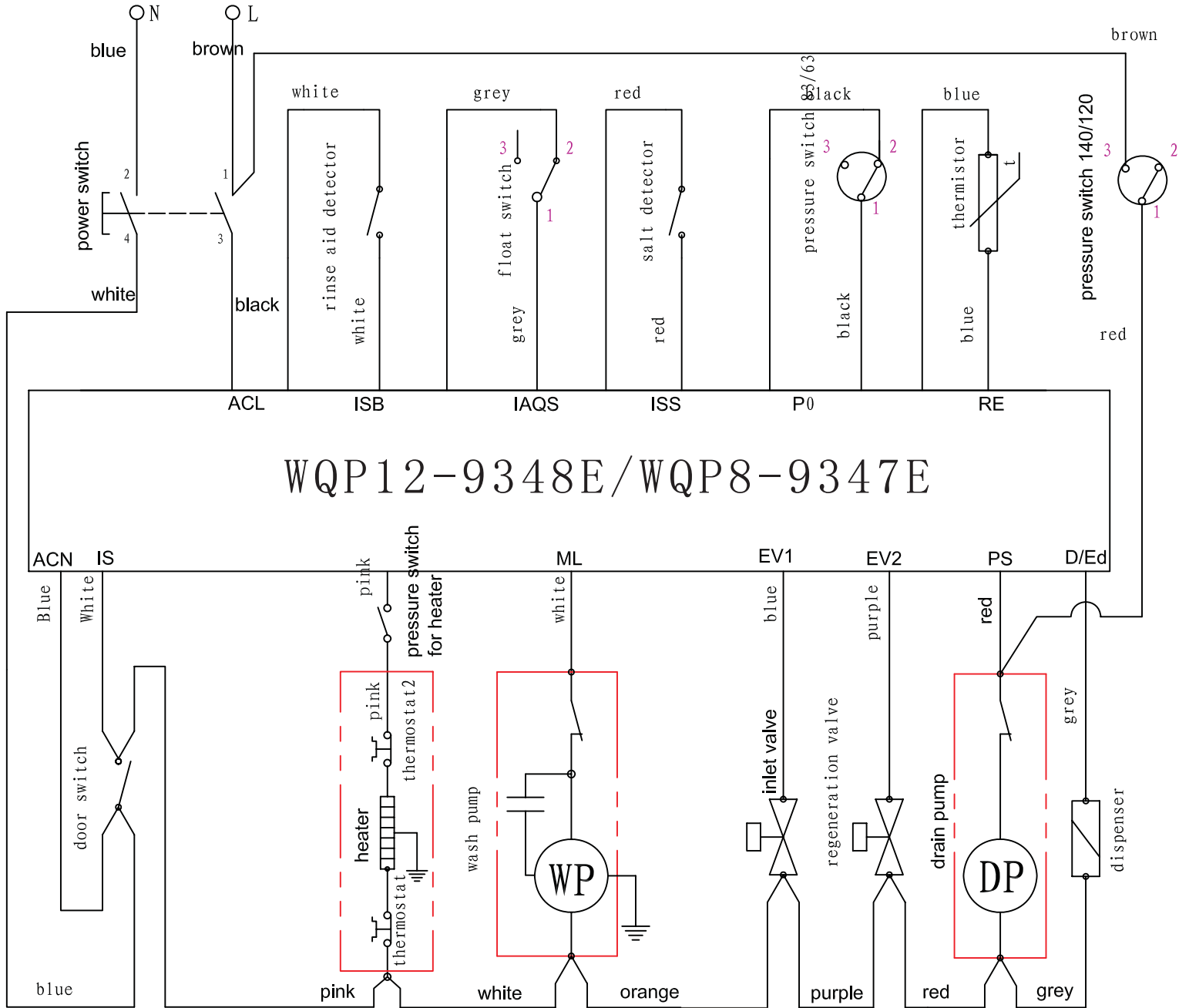

# Model: DI614 DI464

## Control Panel

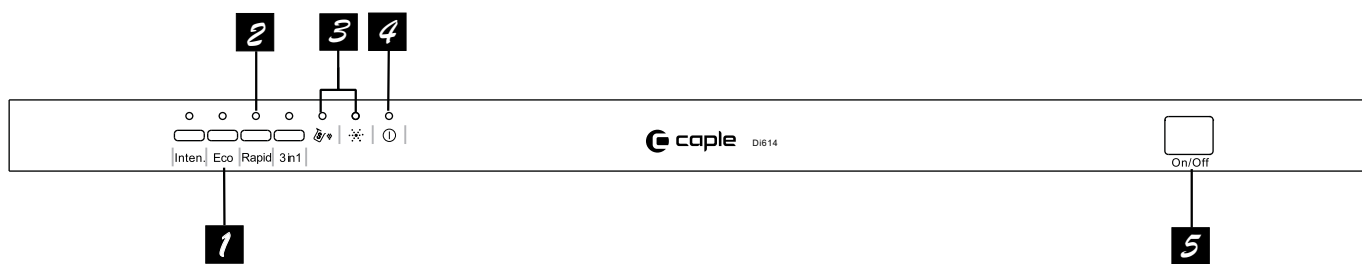

**1** Program button :To select washing program when button is pressed.

**2** Program indicator light: when you select washing program, the correspond light will display.

**3** Salt and Rinse Aid Warning Light: To come on when the softener or dispenser needs to be refilled.

**4** Power on light: To come on when Power ON/OFF button is pressed down.

**5** ON/OFF Button: To turn on/off the power supply.

## Test Program

In order to check the operation of components of appliance and find out the malfunction, we designed this program for technician.

## How to activate Test Program

With the door opened and machine off, press the 3IN1 button. Hold down the 3IN1 button and press the POWER button until the machine enter into Test Program. At that moment, all the LED are flicker with 1Hz. When close the door, there will be a display of model code, and after 2 seconds the test program will be activated.

During test program running, all the program indicators flicker circularly from left to right. When program stay at pause state between 04 step and 05 step, all the program indicators keep lighting.

## Attention

During test program running, you can press 3IN1 button to jump into next step (except inlet valve step).

Once pressure switch reset in the testing process, the appliance will enter water until pressure switch act.

If open the door during testing process, the appliance will pause and all the program indicators will keep lighting. Appliance will continue to run the program after closing door.

In test program, E1, E2, E3, E4, E6 and E7 are valid.

## Test Program Procedure

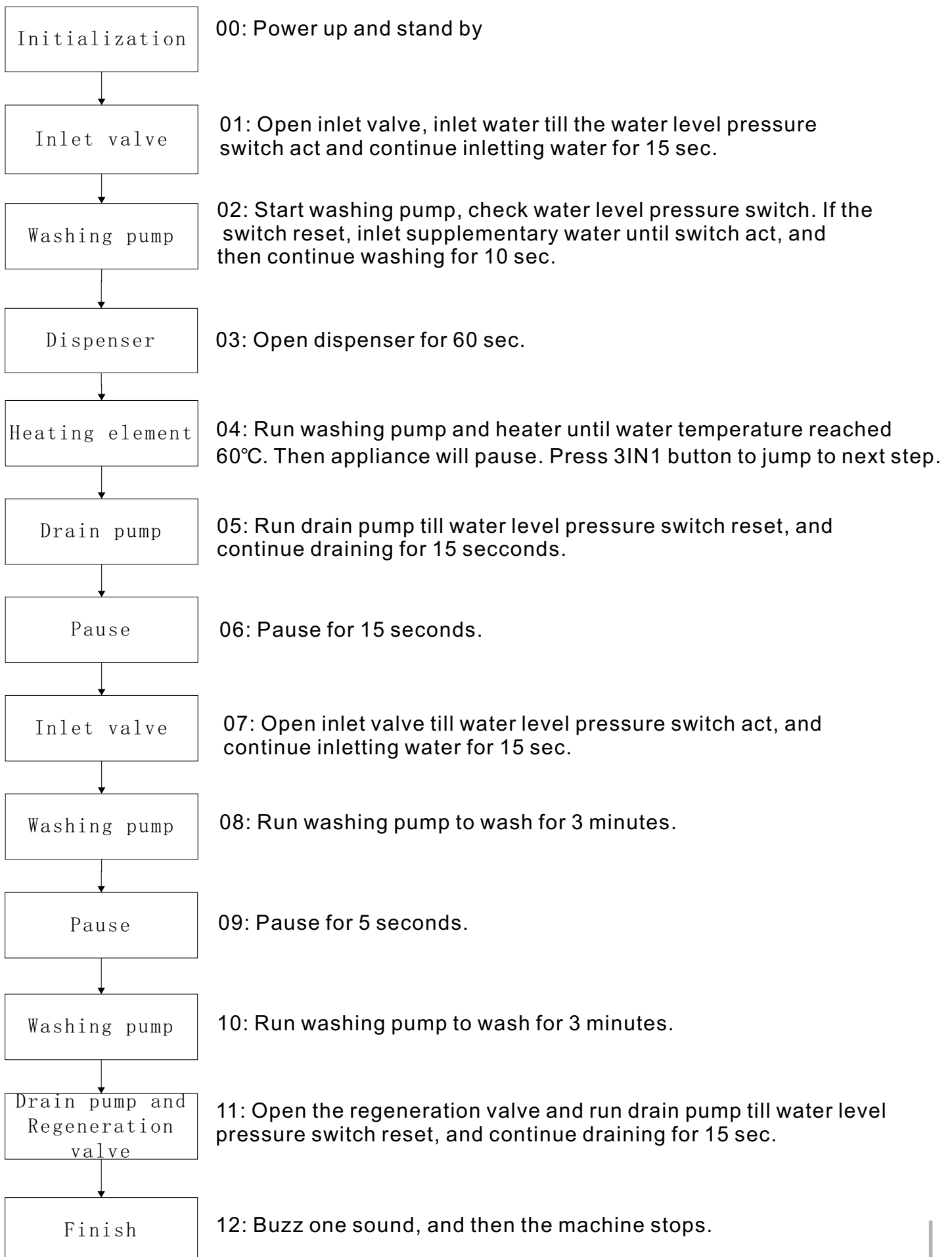

## E1 Longer inlet time

If the inlet valve has been opened for 4 minutes but the water level pressure switch hasn't act, E1 will come on.

When E1 happens, the appliance will active drain pump and cut all the other loads immediately. At the same time, the buzzer will alarm for 30 seconds and 3IN1 indicator will flicker quickly. Then, drain pump will run till the pressure switch reset and continue draining for 60 seconds.

When the supplementary water inlet time is longer than 4 minutes, E1 also comes on.



## E2 Longer drain time

If the drain pump has been running for 4 minutes but the water level pressure switch hasn't reset, E2 will come on.

When E2 happens, drain pump will keep working for 2 minutes and appliance will cut all the other loads immediately. At the same time, the buzzer will alarm for 30 seconds and Rapid indicator will flicker quickly.



## E3 Longer heating time

If the heating element has been working for 60 minutes but the water temperature hasn't reached the proper value detected by NTC. E3 will come on.

When E3 happens, the buzzer will alarm for 30 seconds and 3IN1 and Rapid indicators will flicker quickly. Then, drain pump will run till the pressure switch reset and continue draining for 60 seconds.



**Caution:** during washing program, if appliance has detected NTC failure after heating element starting work, the program will jump to next step after heating 10 minutes. If there is no NTC failure detected and water temperature hasn't reached the desired value, the program will jump to next step after heating 20 minutes.

## E4 Overflow

At any time, if overflow pressure switch act and keep for longer than 2 seconds, the E4 will come on.

When E4 happens, the appliance will activate drain pump and cut all the other loads immediately. At the same time, the buzzer will alarm for 30 seconds and Economy indicator will flicker quickly. Then, drain pump will run till the water level pressure switch reset and continue draining for 60 seconds.

Then appliance will detect repeatedly whether water level pressure switch act or not. If it act, run the drain pump until the pressure switch reset.

Flickering



### Caution:

Priority level of E4 is the highest. E4 operation is valid after other error operations have done. When E4 operation has done, all the others are invalid.

## E6 Open-circuit failure of thermistor

Once open-circuit failure of thermistor is detected by controller, the appliance will activate the drain pump and cut all the other loads. At the same time, the buzzer will alarm for 30 seconds and Economy and Rapid indicators will flicker simultaneously and quickly. Then, drain pump will run till the pressure switch reset and continue draining for 60 seconds.

Flickering



## E7 Short-circuit failure of thermistor

Once short-circuit failure of thermistor is detected by controller, the appliance will activate the drain pump and cut all the other loads. At the same time, the buzzer will alarm for 30 seconds and Economy, Rapid and 3IN1 indicators will flicker simultaneously and quickly. Then, drain pump will run till the pressure switch reset and continue draining for 60 seconds.

Flickering





If the problem has not been solved through all the inspection mentioned above, maybe the PCB has a malfunction. So, replace PCB and test again.

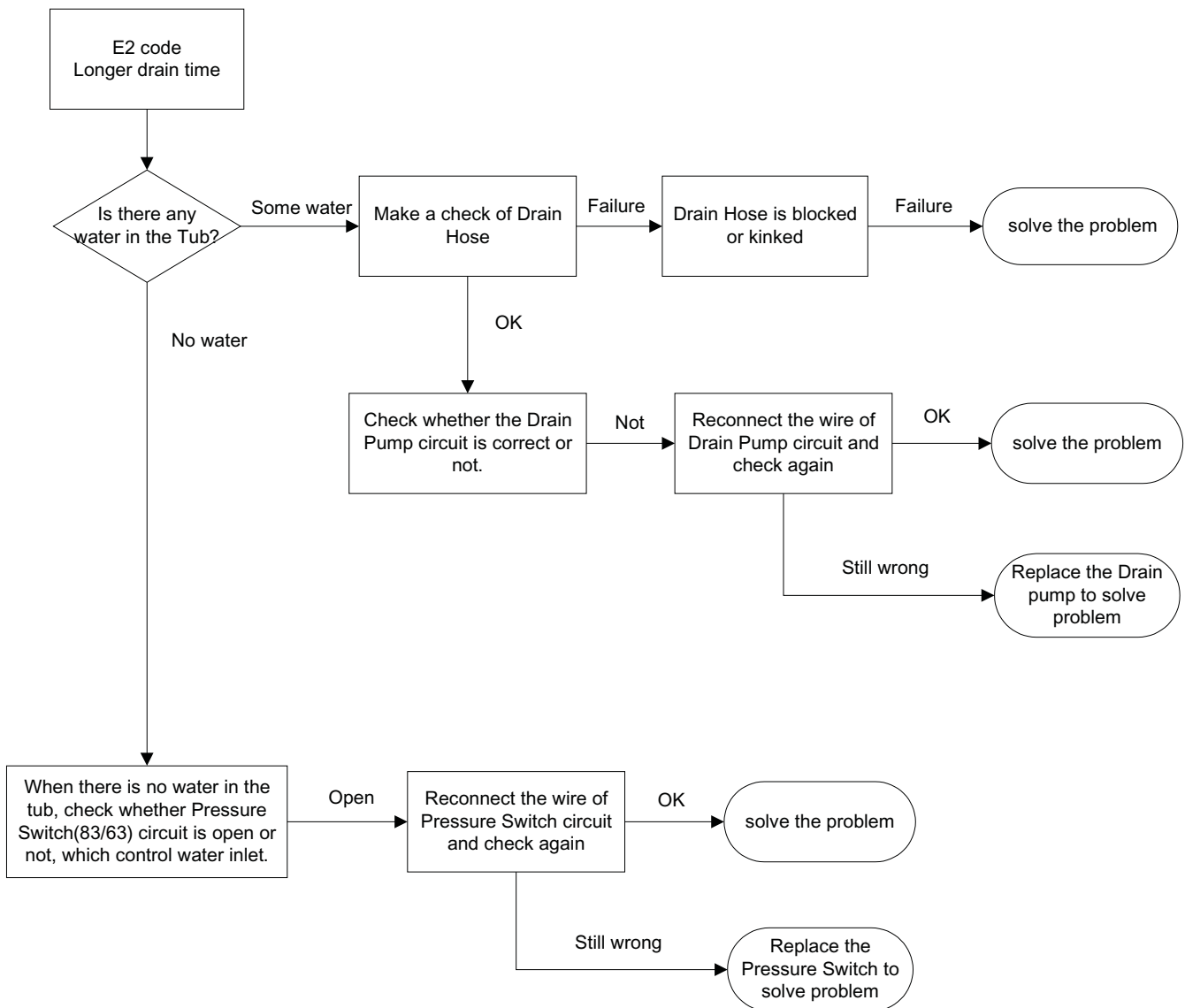

If the problem has not been solved through all the inspection mentioned above, maybe the PCB has a malfunction. So, replace PCB and test again.

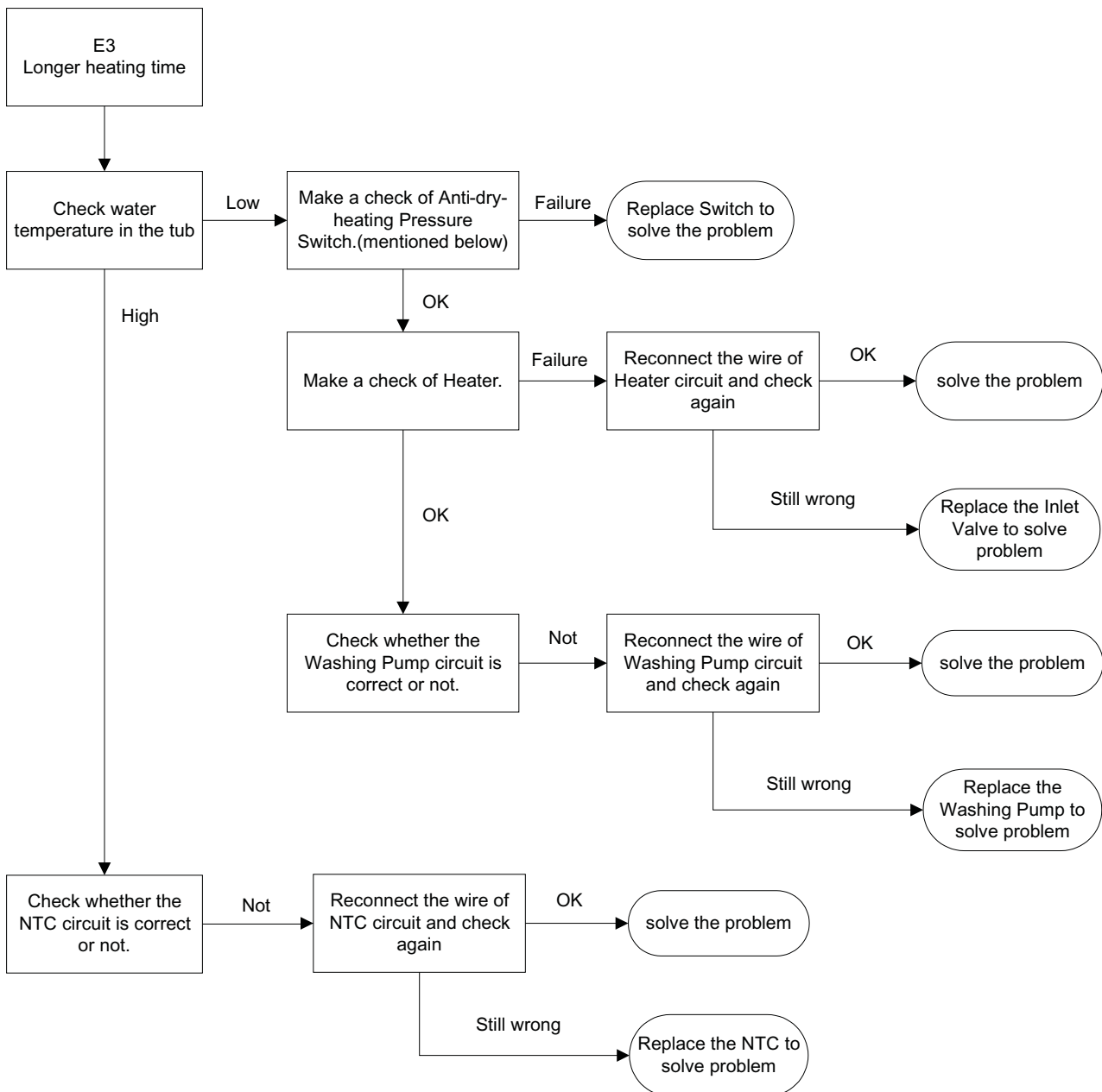

If the problem has not been solved through all the inspection mentioned above, maybe the PCB has a malfunction. So, replace PCB and test again.

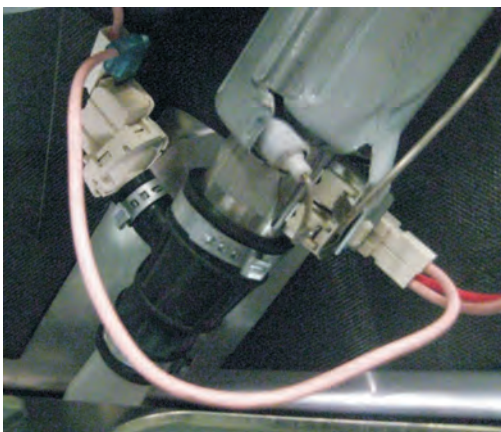

Eliminate switch's influence

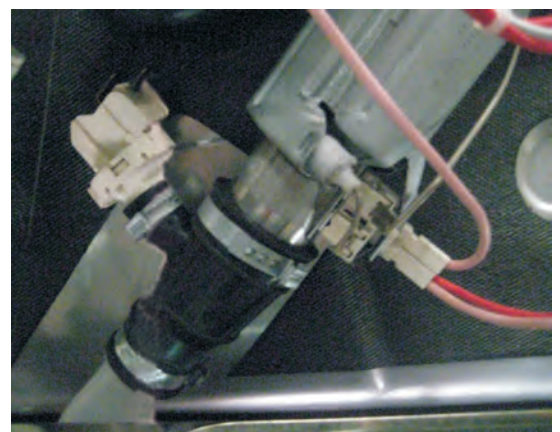

Eliminate the influence of Anti-dry-heating Pressure Switch, as above picture, and run the Test Program to test. If E3 come again, Pressure Switch is normal. If E3 doesn't come, fault Pressure switch needs replacement.

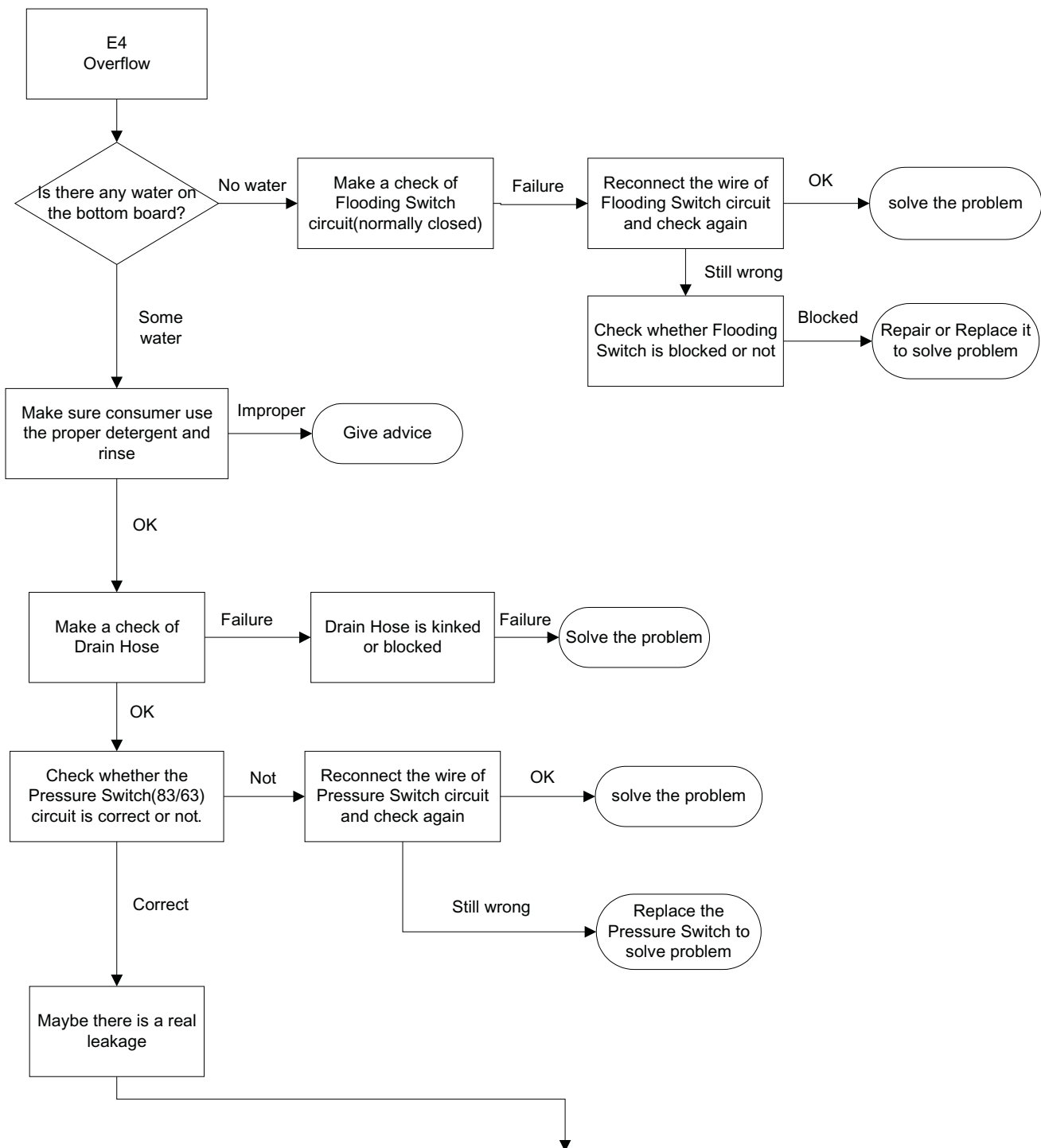

## Do as follows

Remove two side panels

Remove the water from the bottom board and make sure there is no water at the bottom board.

Restart the dishwasher with a strong or standard wash program as a leakage could easily repeat at a higher temperature and after a long period of running time.

Observe the bottom tray every twenty minutes.

If any water appears, you will find out which areas, such as motor, drain pump, sump, softener, and hoses between them, and also clips at the end of each hose, besides the weld seam at the bottom of the tub.

If hours passed, but no water comes out, you should stop the dishwasher with sufficient water in the inner tub, and observe it again after leaving it alone for one to two hours.

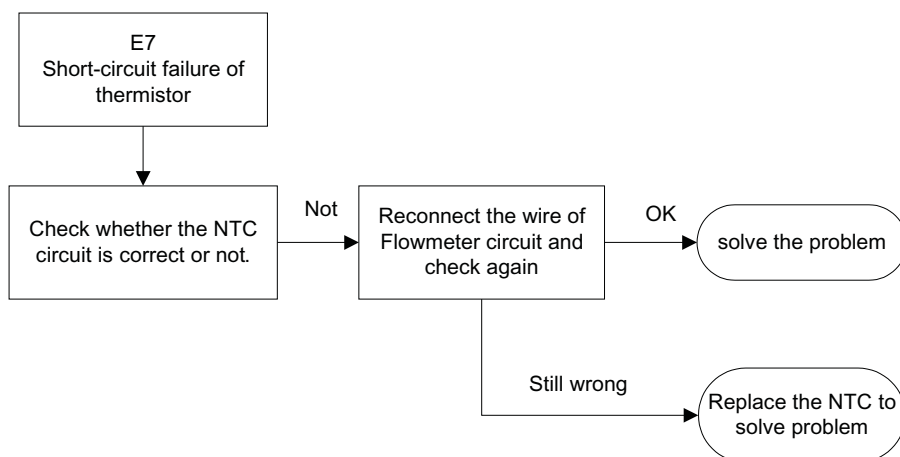
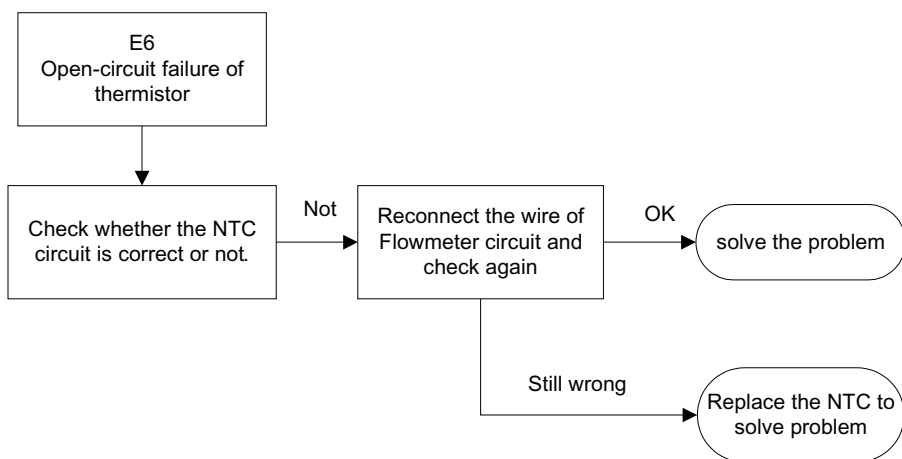

If the problem has not been solved through all the inspection mentioned above, maybe the PCB has a malfunction. So, replace PCB and test again.

## Caution:

Because the real situation is unpredictable, inspection trees mentioned in this manual are for reference only.



# Dishwasher Error Codes



# Error Codes

ERROR CODES	MEANING	REMARK
E1	Inlet time out (If the water valve continues working for 4 minutes, the dishwasher will start E1 alarm)	
E2	Draining time out (If the drain pump continues working for 4 minutes, the dishwasher will start E2 alarm)	Only for pressure switch
E3	Heating time out (If the dishwasher is heating for over 60 minutes and does not reach the required temperature, The dishwasher will start E3 alarm )	
E4	Overflow (If the overflow switch is activated ,the dishwasher will start E4 alarm)	
E6	Failure of temperature sensor	
E7	Failure of temperature sensor	

## How do you know the error codes?

- 1、 Only for electronic control dishwasher
- 2、 For the dishwasher with an LED or LCD display. When the dishwasher has something wrong, corresponding Error codes will displayed in the LED or LCD display, for example:



# How do you know the error codes?

3.1、 For dishwashers without an LED or LCD display, different flashing indicator lights mean different error codes, you will find them in the Instruction Manual



Main

Rinse

Dry

	Dry	Rinse	Main
E1	Flash	X	X
E2	X	Flash	X
E3	Flash	Flash	X
E4	X	X	Flash
E6	X	Flash	Flash
E7	Flash	Flash	Flash

# How do you know the error codes?

3.2、 For dishwashers without LED or LCD display, different flashing indicator lights mean different error codes, you will find them in the Instruction Manual,



Eco

Rinse

Rapid

	Rapid	Rinse	Eco
E1	Flash	X	X
E2	X	Flash	X
E3	Flash	Flash	X
E4	X	X	Flash
E6	X	Flash	Flash
E7	Flash	Flash	Flash

## How do you know the error codes?

3.3、 For dishwashers without LED or LCD display, different flashing indicator lights mean different error codes, you will find them in the Instruction Manual.



Glass

Rapid

Sock

	Sock	Rapid	Glass
E1	Flash	X	X
E2	X	Flash	X
E3	Flash	Flash	X
E4	X	X	Flash
E6	X	Flash	Flash
E7	Flash	Flash	Flash

# How do you know the error codes?

3.4、 For dishwashers without LED or LCD displays, different flashing indicator lights mean different error codes, you will find them in the Instruction Manual.



Normal

Rinse

Rapid

	Rapid	Rinse	Normal
E1	Flash	X	X
E2	X	Flash	X
E3	Flash	Flash	X
E4	X	X	Flash
E6	X	Flash	Flash
E7	Flash	Flash	Flash

## How do you know the error codes?

3.5、 For dishwashers without LED or LCD display, different flashing indicator lights mean different error codes, you will find them in the Instruction Manual.



Eco

Rapid

3IN1

	3IN1	Rapid	Eco
E1	Flash	X	X
E2	X	Flash	X
E3	Flash	Flash	X
E4	X	X	Flash
E6	X	Flash	Flash
E7	Flash	Flash	Flash

# CONTENT

➤ E1 Alarm

➤ E2 Alarm

➤ E3 Alarm

➤ E4 Alarm

➤ E6 Alarm

➤ E7 Alarm

➤ Main Electric parts

➤ Installation



## E1 Alarm

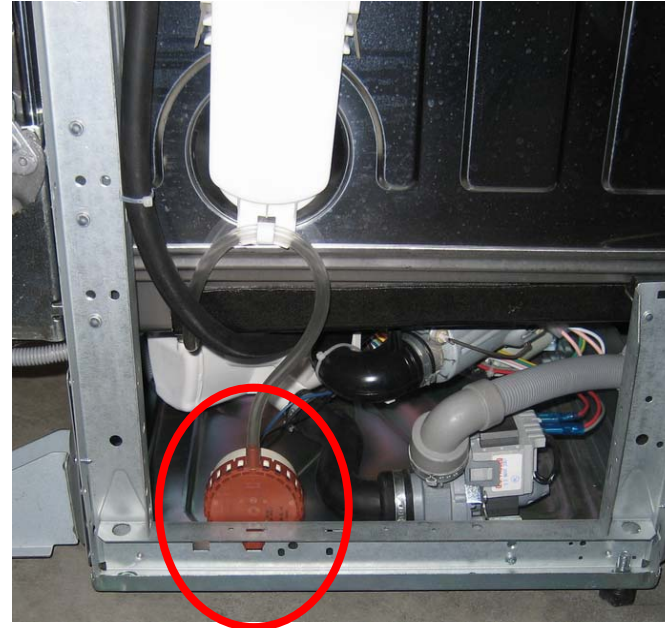

theory :

If the water valve continues working for 4 minutes, the dishwasher will return an E1 alarm.



# E1 Alarm

## Analysis1:

There is no water flow into the dishwasher

Check1.1: The tap does not open



## Analysis1:

There is no water flow into the dishwasher

Check1.2: Water valve circuit fault (cannot open)

First check terminal of valve connect well

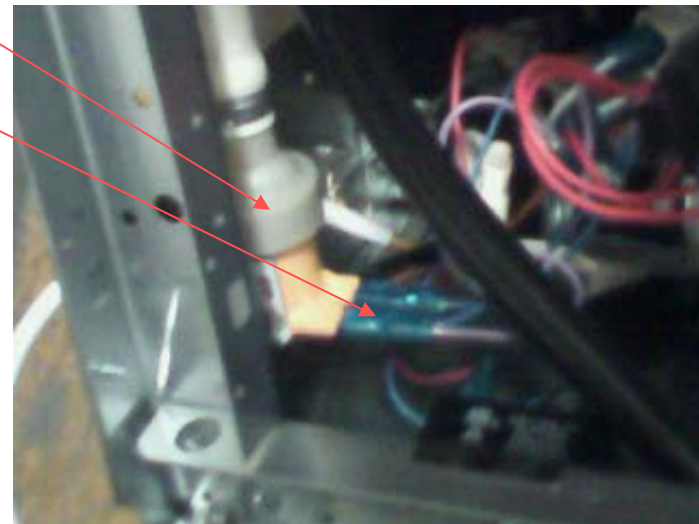

## Analysis1:

There is no water flow into the dishwasher

Check1.2: Water valve circuit fault (cannot open)

then check terminal of PCB connect well

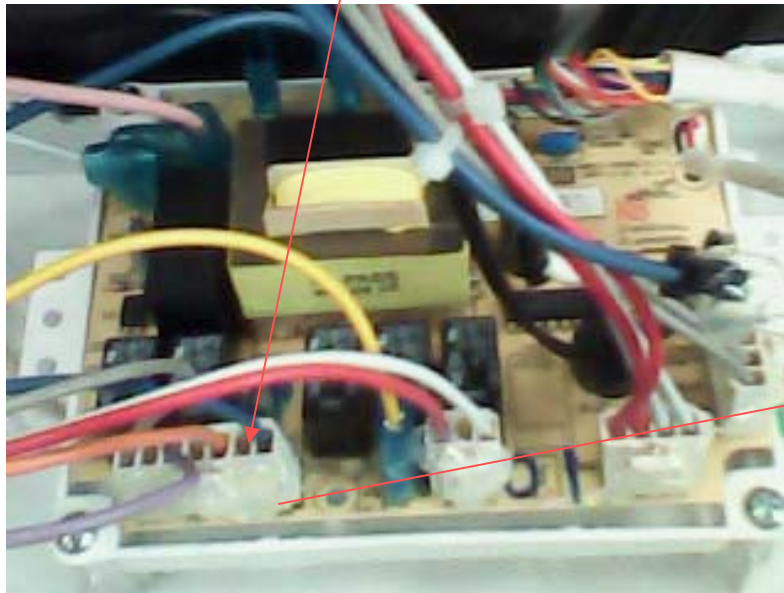

Marked with "EV1"



# E1 Alarm

## Analysis1:

There is no water flow into the dishwasher

Check1.3: Confirm the terminal of Pressure switch and PCB are tightly connected

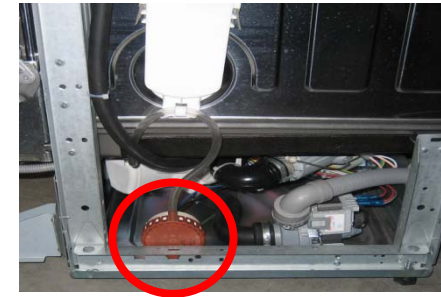

Only for those controlled with pressure switch

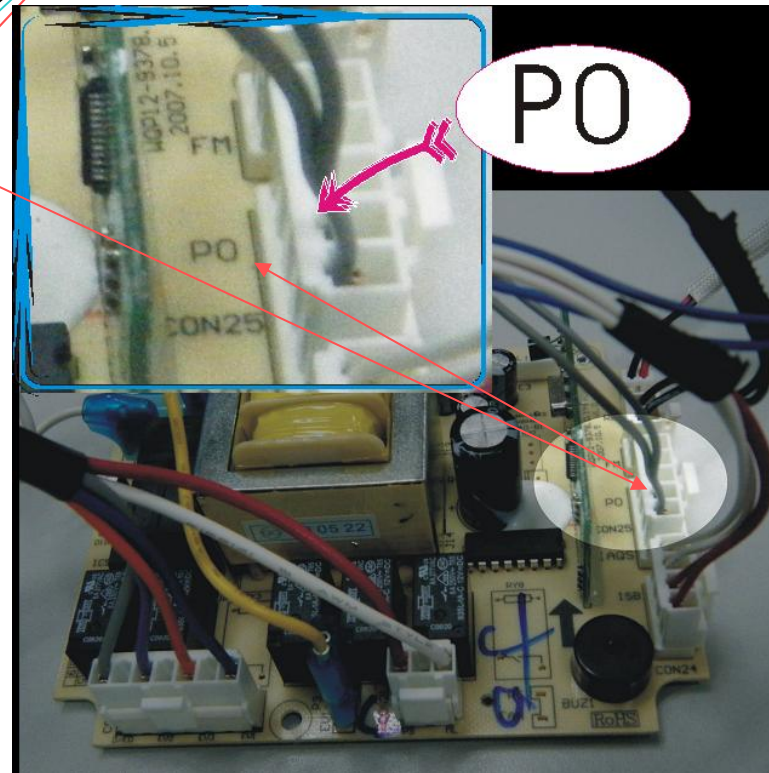
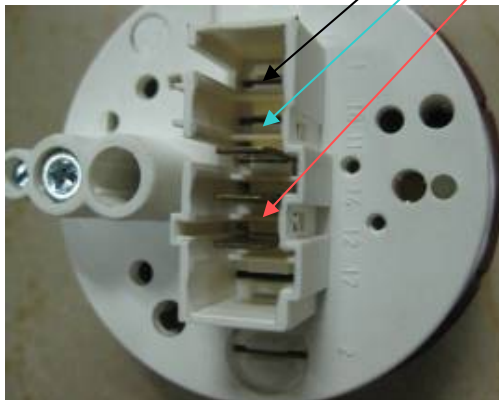
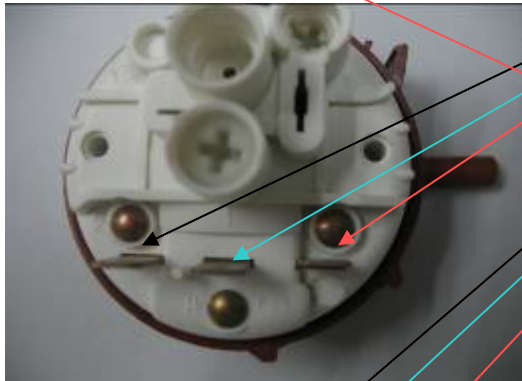



# E1 Alarm

## Analyse1:

There is no water flow into the dishwasher

Check1.4: Pressure switch fault



Only for those controlled with pressure switch

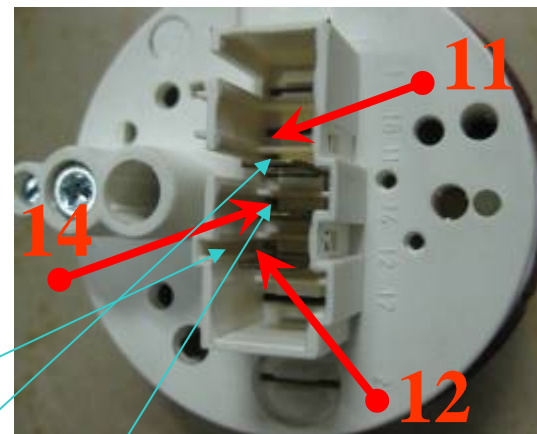
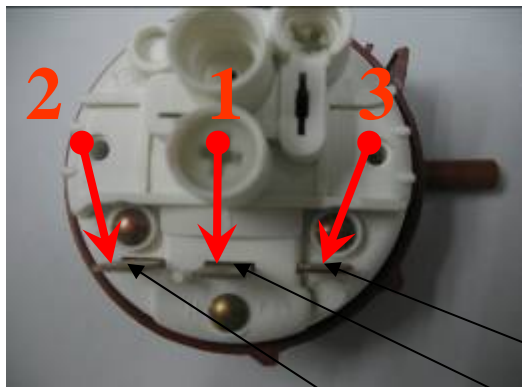

NC

COM

NO

When Terminal NC and COM can not open circuit even over work Pressure, It means wrong



# E1 Alarm

## Analyse1:

There is no water flow into the dishwasher

Check1.5: Confirm the terminal of Flow meter and PCB are tightly connected

Only for those controlled with Flow meter

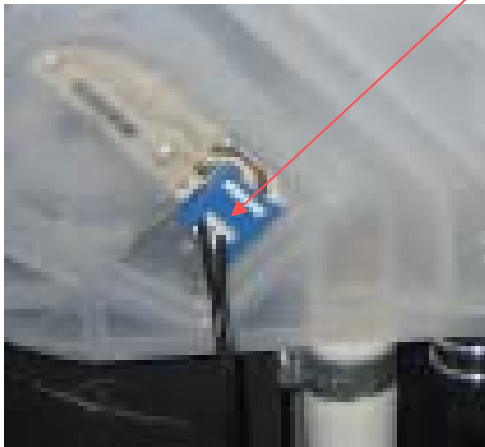

In PCB, This terminal is marked with "FM"



# E1 Alarm

## Analyse2:

There is little water flow into the dishwasher

Check2.1: Water pressure is very low ( $< 0.04\text{Mpa}$ )



## Analysis2:

There is little water flow into the dishwasher

Check2.2: Drain hose fault

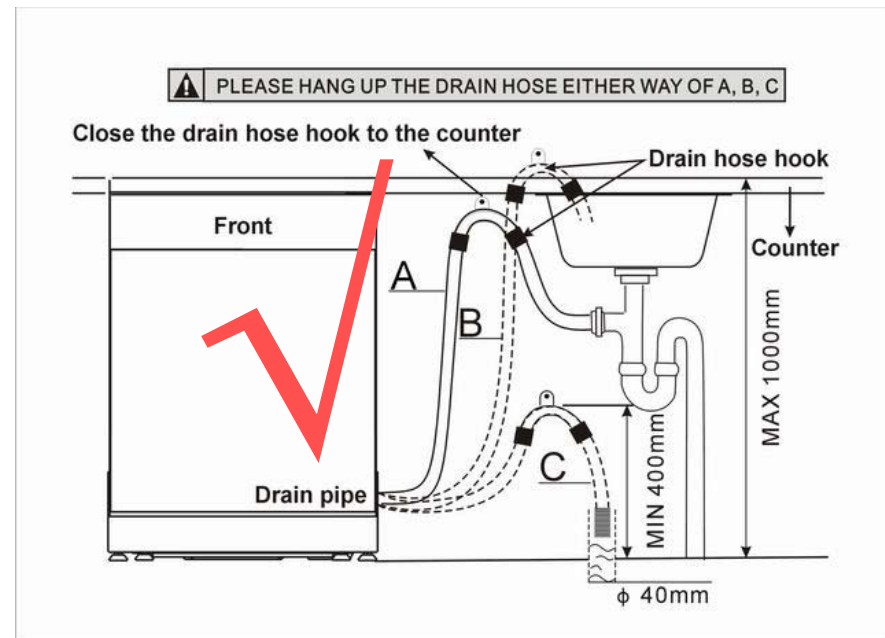



# E1 Alarm

## Analysis3:

Check3.1: AQUASTOP is at fault (only for the dishwasher with AQUASTOP device)



Here is damaged



# E2 Alarm

The Pressure switch control for water inlet

## Theory :

If the dishwasher has continued draining water for 4 minutes the appliance will start E2 alarm.

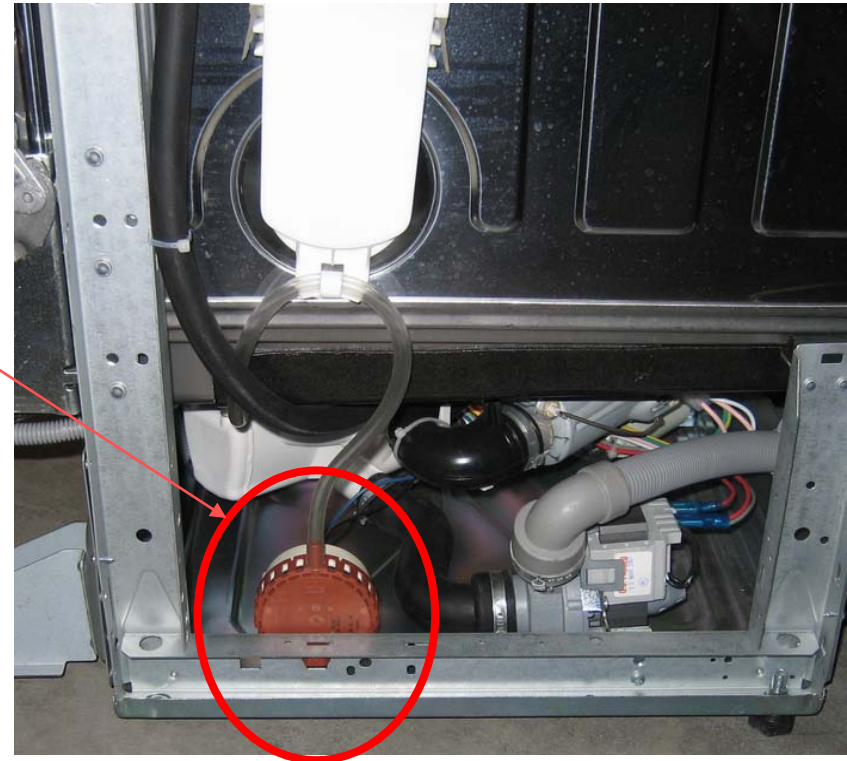



# E2 Alarm

## Analysis1:

There is water in dishwasher

Check1.1: the wiring between drain pump and PCB, and confirm the terminal of PCB and pump are tightly connected.

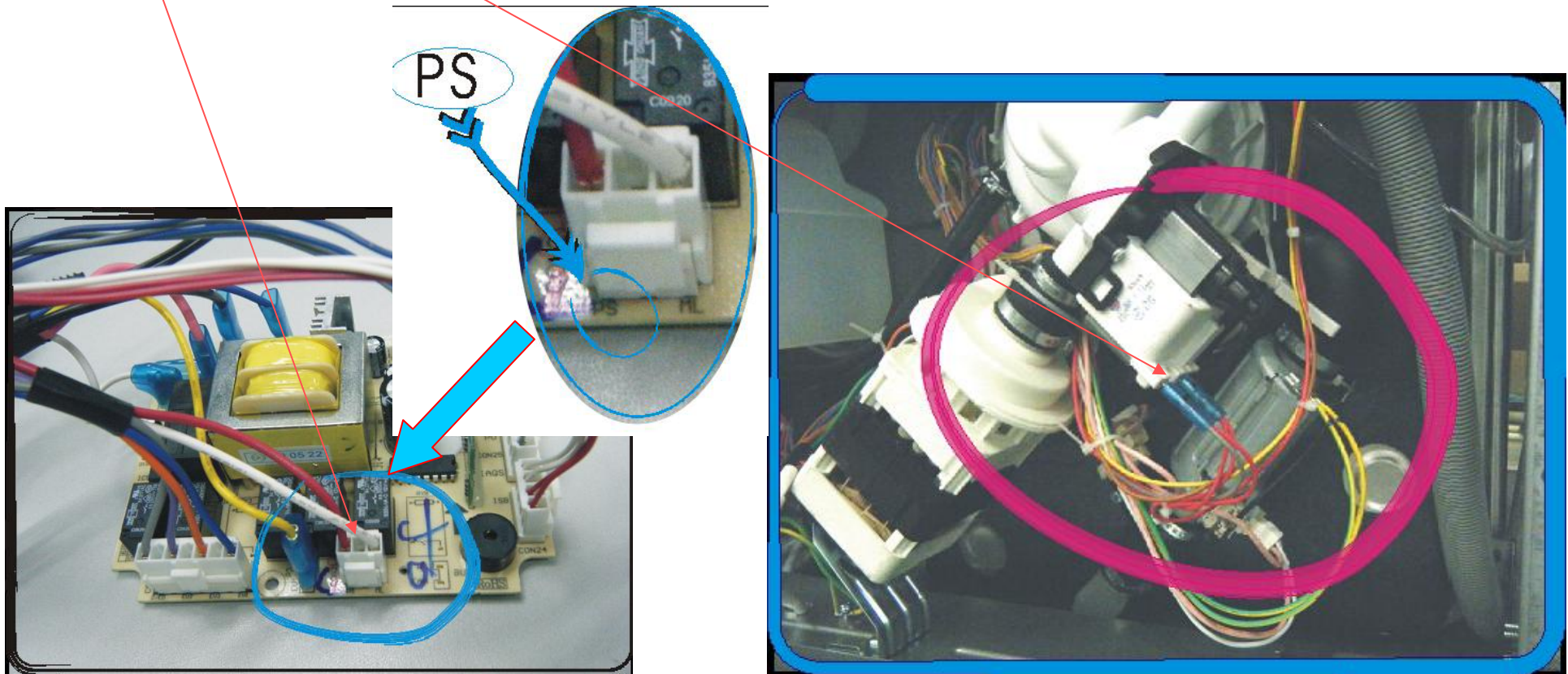



# E2 Alarm

## Analysis1:

There is water in dishwasher

Check1.2: Drain hose is blocked or kinked

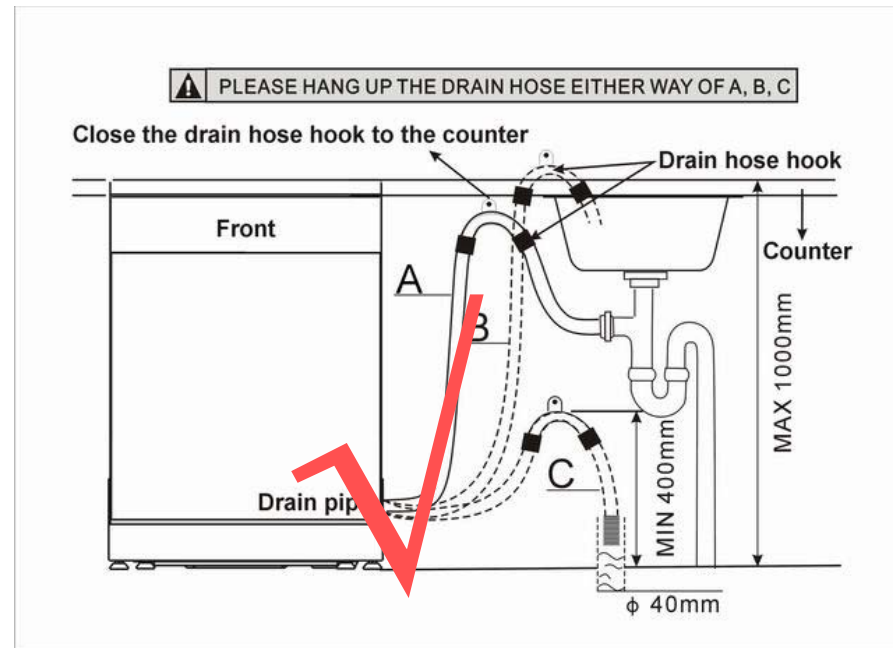

# E2 Alarm

## Analysis2:

There is no water in dishwasher

Check2.1: the wiring between pressure switch and PCB, and confirm the terminal of PCB and pressure switch are tightly connected. (only for controlled with pressure switch)

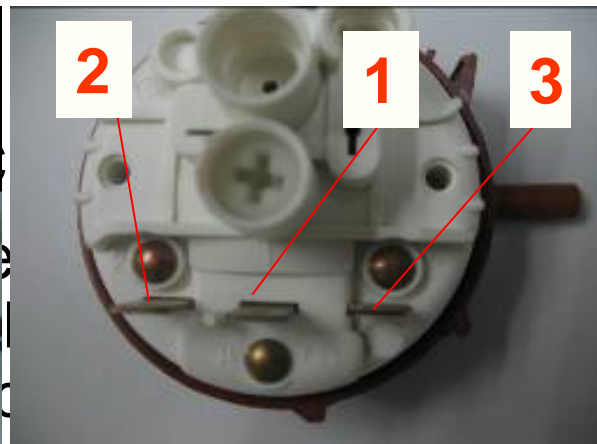
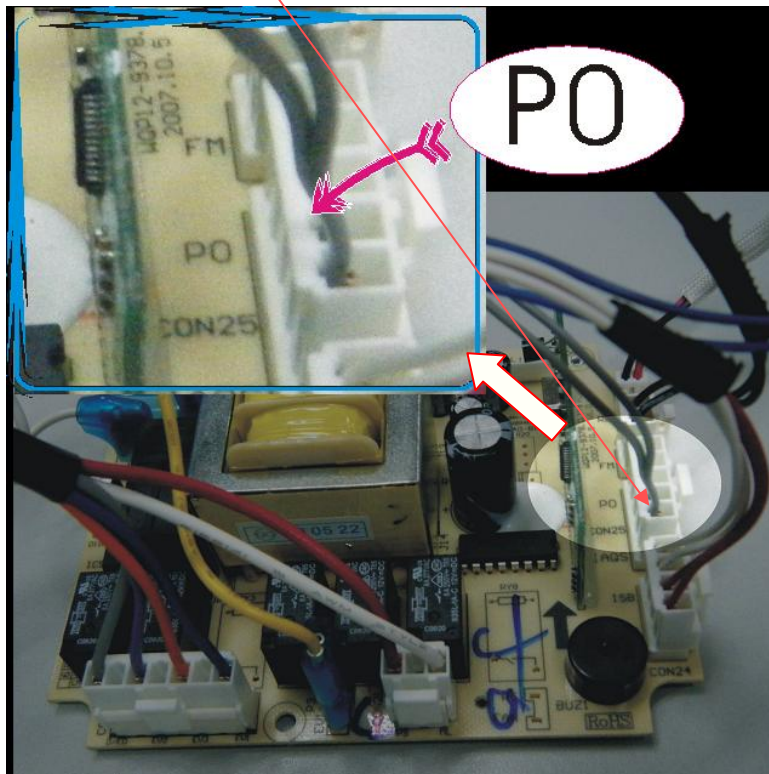

**Manufacturer: Elbi**

**1- COM**

**2 - NC**

**3 - NO**

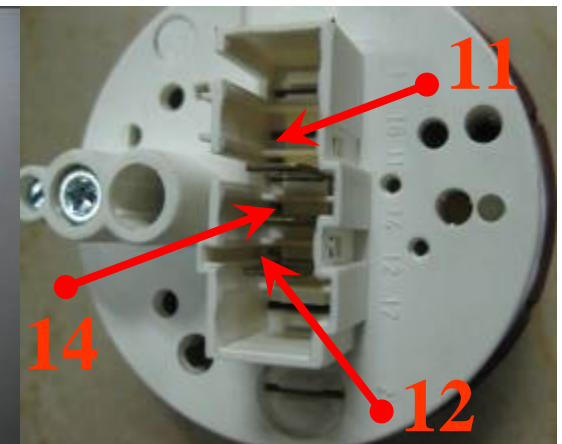

**Manufacturer: EMZ**

**11 - COM**

**12 - NC**

**14 - NO**



## E3 Alarm

### Theory :

If the heating element has continued working for 60 minutes but doesn't reached required temperature, the dishwasher will start E3 alarm.



# E3 Alarm

## Analysis1:

Temperature in dishwasher is lower

Check1.1: confirm the terminal of PCB and heating element are tightly connected.

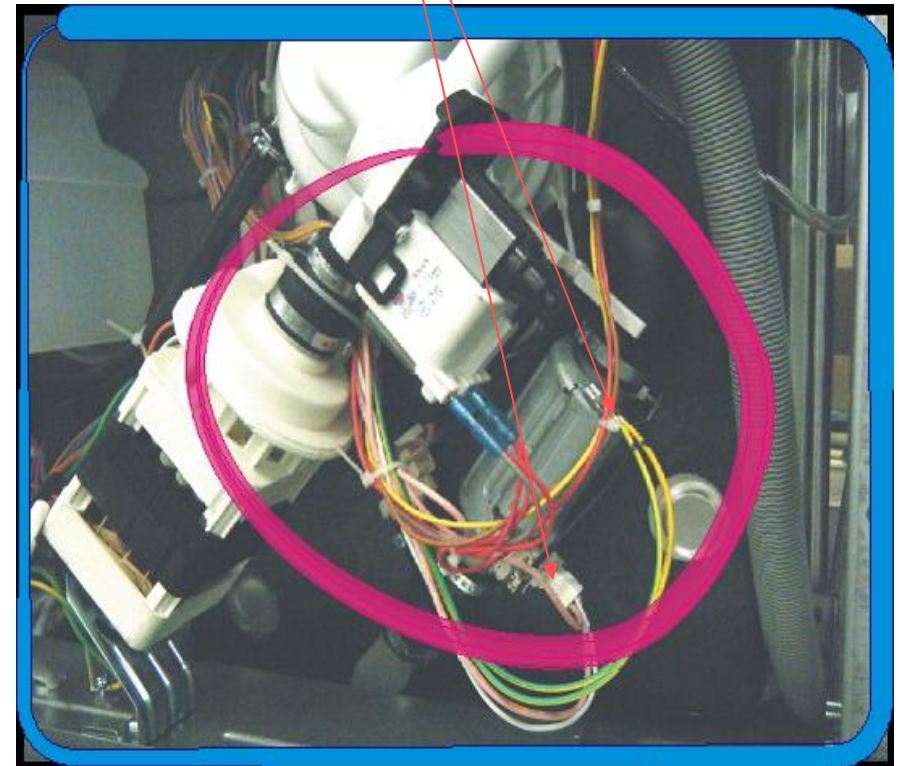
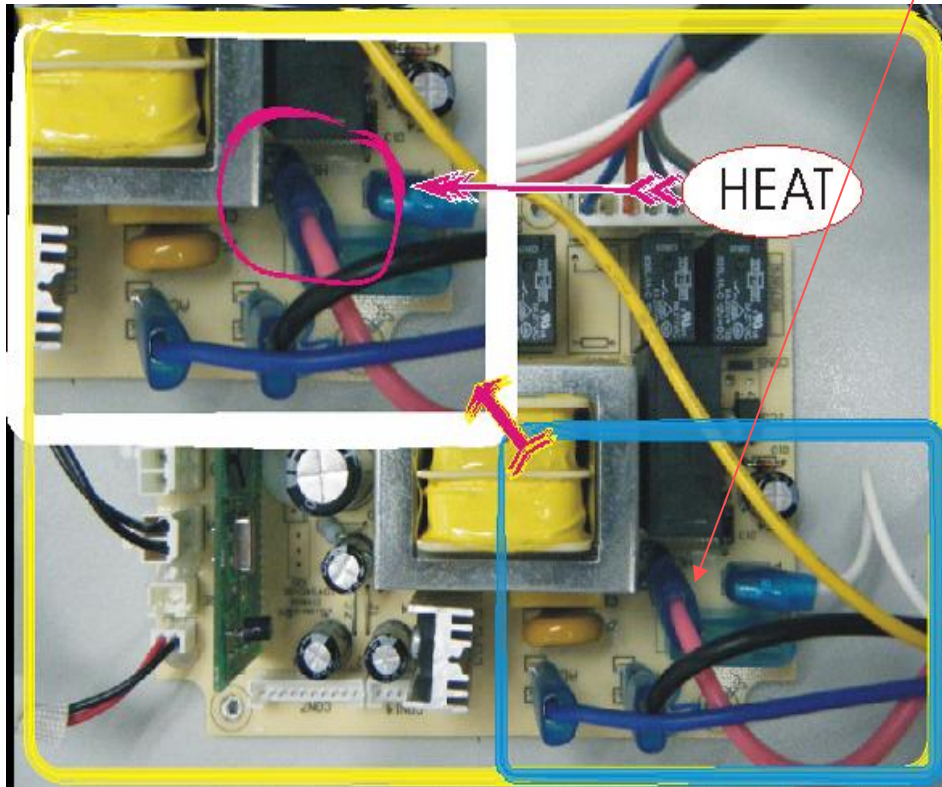



# E3 Alarm

## Analysis1:

Temperature in dishwasher is lower

Check1.2: confirm the terminal of PCB and heating element are tightly connected.

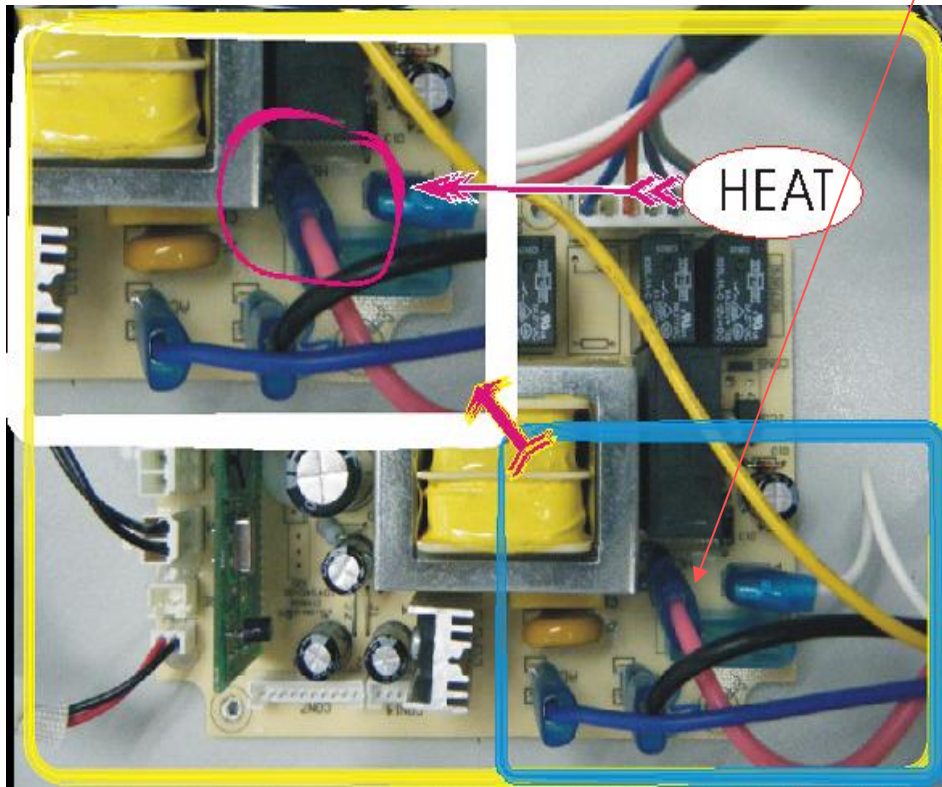



## E3 Alarm

### Analysis1:

Temperature in dishwasher is lower

Check1.3: confirm the terminal of motor and PCB are tightly connected

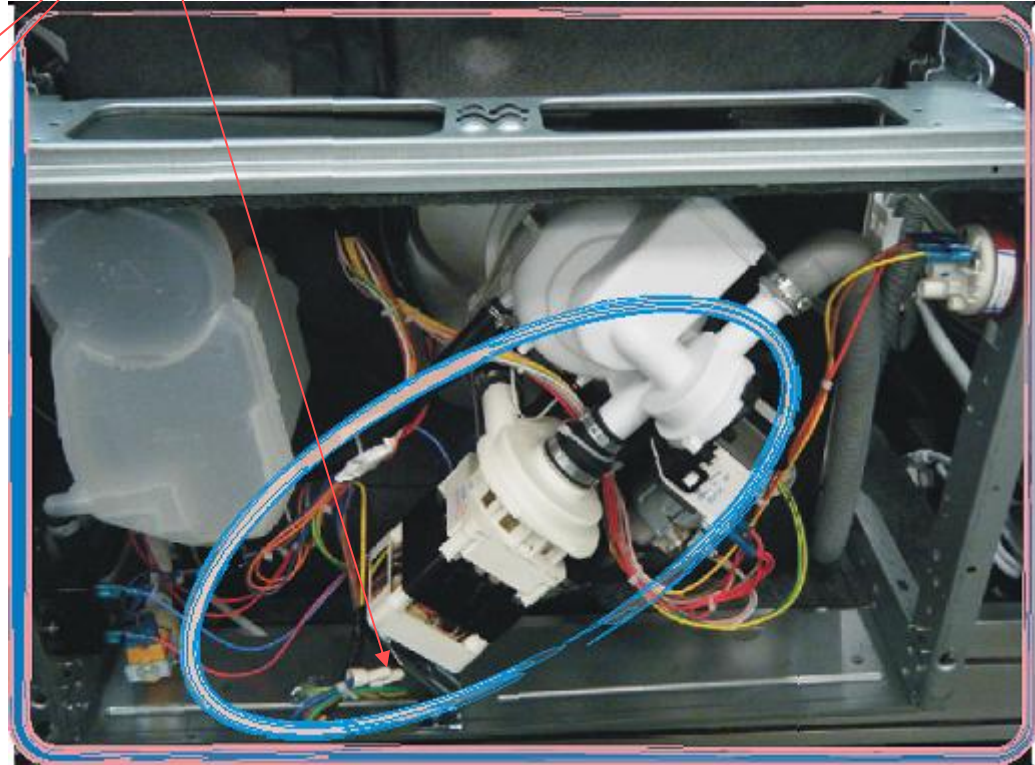
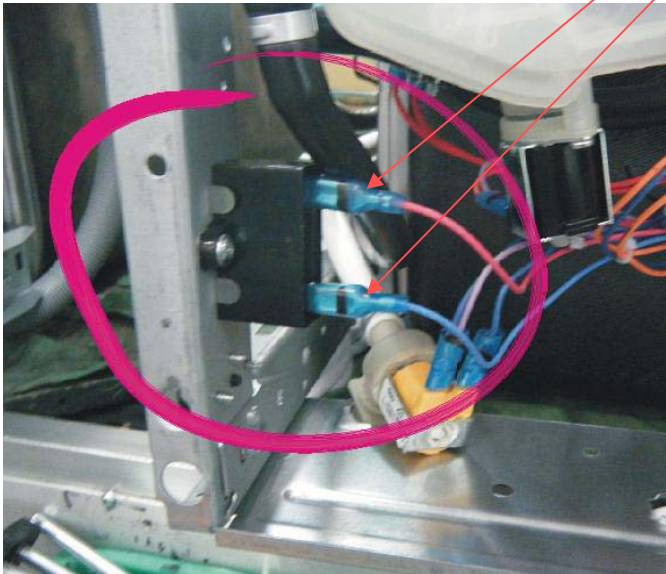



## E3 Alarm

### Analysis1:

Temperature in dishwasher is lower

Check1.3: confirm the terminal of motor and PCB are tightly connected

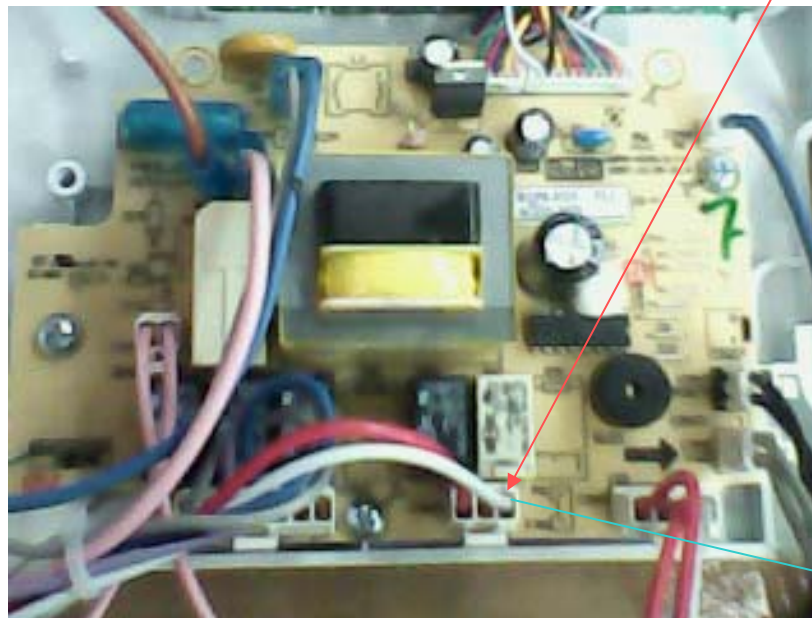

Here marked  
with "ML"



## E3 Alarm

### Analysis1:

Temperature in dishwasher is lower

Check1.4: confirm the terminal of pressure switch and PCB are tightly connected





## E3 Alarm

### Analysis1:

Temperature in dishwasher is lower

Check1.4: confirm the terminal of pressure switch and PCB are tightly connected

Here marked  
with "P2"



## E3 Alarm

### Analysis2:

Temperature in dishwasher is high

Check2.1: confirm the NTC is in close contact with the bottom of tub.

Thermostat is detached,  
because the bracket is  
loose in here





## E3 Alarm

### Analysis2:

Temperature in dishwasher is high

Check2.1: confirm the NTC is closely contacted with the bottom of tub.

Close contact

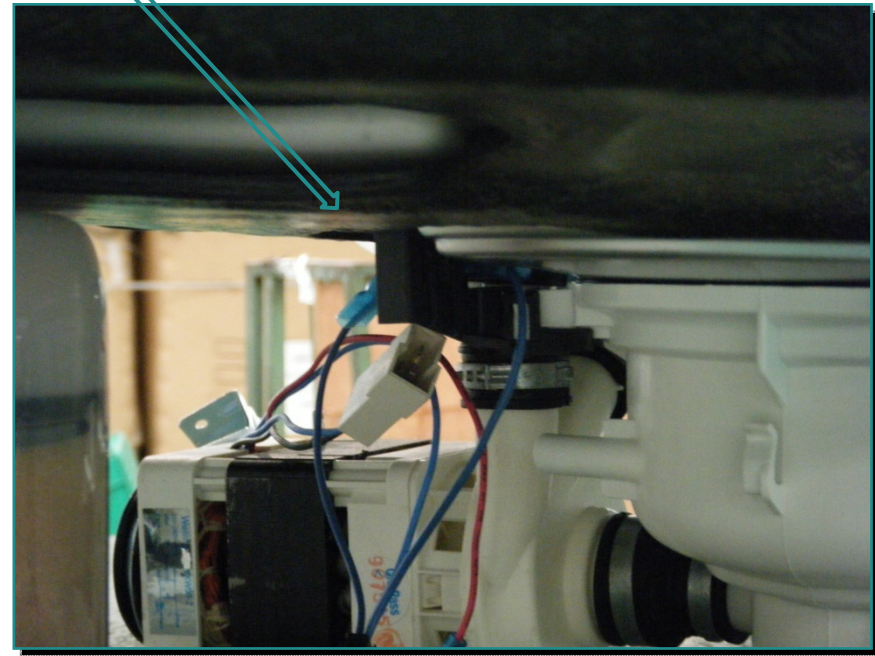
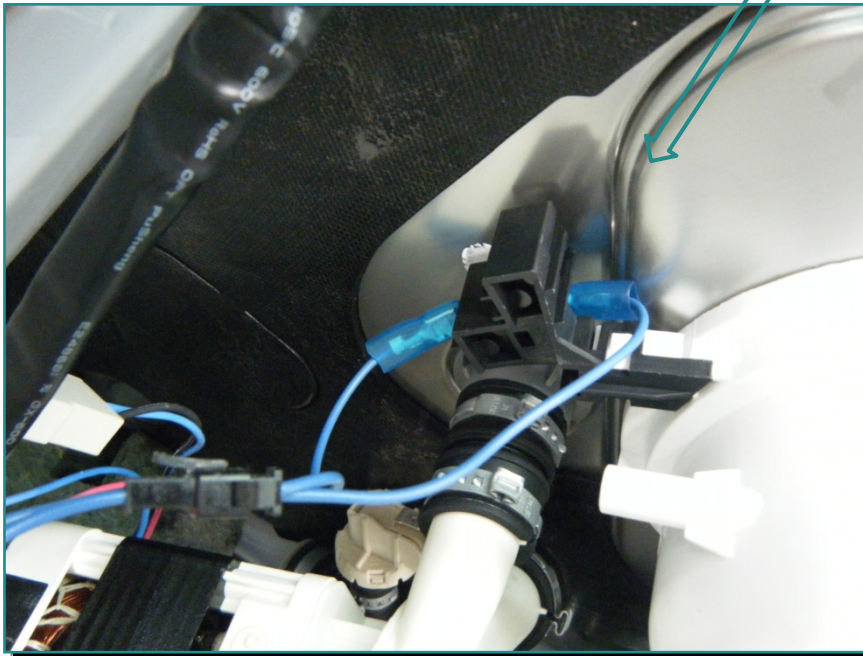

## E4 Alarm

### The theory:

There is a floater device on the bottom tray, If there is any water in the tray, The foam floater will come up to activate the micro-switch, causing the dishwasher to stop running and show E4 alarm.

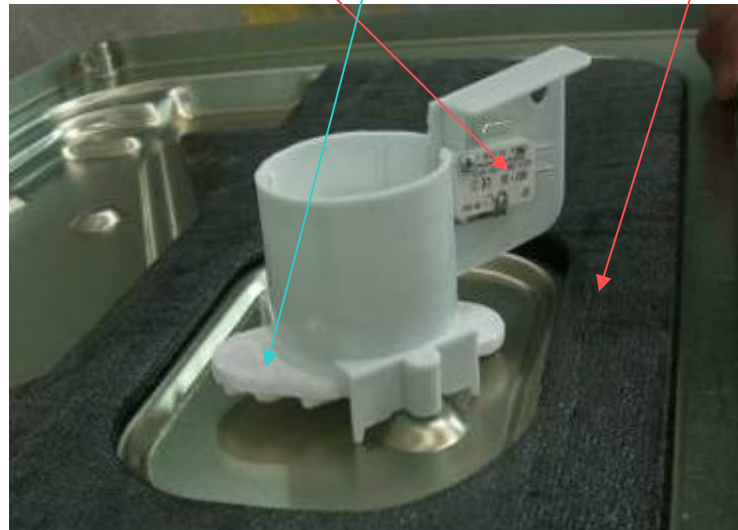



## E4 Alarm

### Analysis1:

There is water in the bottom tray

In this case, you must find out where it is leaking?

Check1.1: used bad washing liquid





## E4 Alarm

### Analysis1:

There is water in the bottom tray

In this case, you must find out where is leaking?

Check1.2: Drain hose is blocked or kinked





# E4 Alarm

## Analysis1:

There is water in the bottom tray

In this case, you must find out where it is leaking?

Check1.3: Confirm terminal of flow meter and PCB are tightly connected.  
(only for those controlled with a flow meter)



Here Marked  
with "FM"

# E4 Alarm

## Analysis1:

There is water in the bottom tray

In this case, you must find out where it is leaking?

Check1.4: some connecting pipes leaking

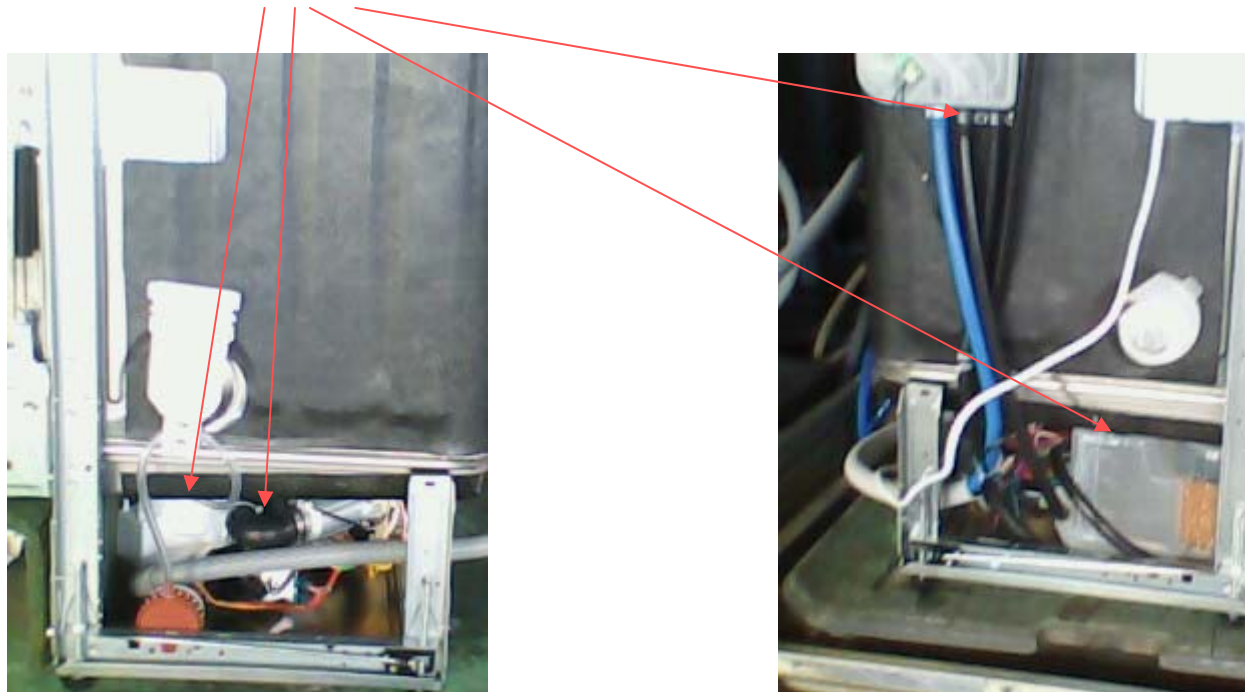



## E4 Alarm

### Analyse1:

There is water in the bottom tray

In this case, you must find out where it is leaking?

Check1.4: some connecting pipes leaking

Do as follows:

- Remove the side panel;
- Remove the water from the bottom tray and make sure there is not any water at the bottom tray.
- Restart the dishwasher with a strong or standard wash program as a leakage could easily repeat at a higher temperature and after a long period of running time.
- Observe the bottom tray every twenty minutes.



## E4 Alarm

### Analysis1:

There is water in the bottom tray

In this case, you must find out where it is leaking?

Check1.4: some connecting pipes for leaking

- If any water appears, you will have found out in which areas, such as motor, drain pump, sump, softener, and hoses between them, and also clips at the end of each hose, besides the weld seam at the bottom of the tub.
- If hours passed, but no water comes out, you should stop the dishwasher with sufficient water in the inner tub, and observe it again after leaving it alone for one to two hours.

# E4 Alarm

## Analysis2:

There is no water in the bottom tray

Check2.1: float is blocked

In this picture, the float is blocked, it will activate the micro-switch.



# E4 Alarm

## Analysis2:

There is no water in the bottom tray

Check2.2: Confirm terminal of micro-switch and PCB are tightly connected

Here marked with "IAQS"

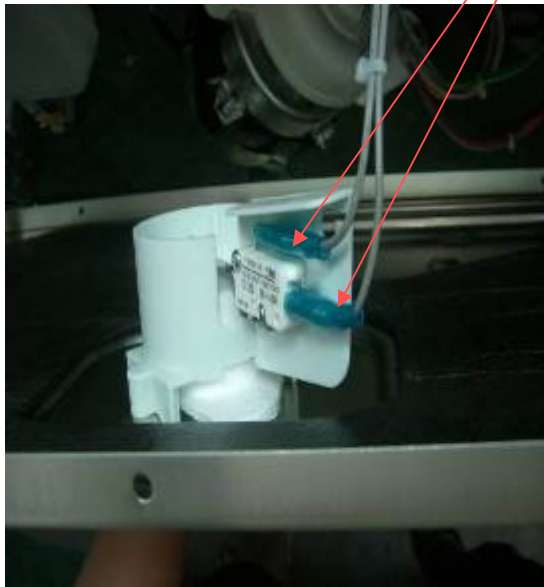



## E6 Alarm

The theory:

If the PCB detect the NTC circuit is open after dishwasher started, the appliance will start E6 alarm.





# E6 Alarm

## Analysis1:

Check1.1: confirm the terminal of NTC and PCB are tightly connected.

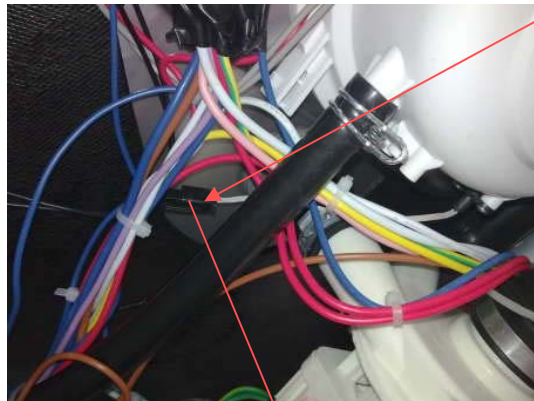

Here marked with "RE"



# E6 Alarm

## Analysis1:

Check1.2: confirm the terminal of PCB and thermostat are tightly connected

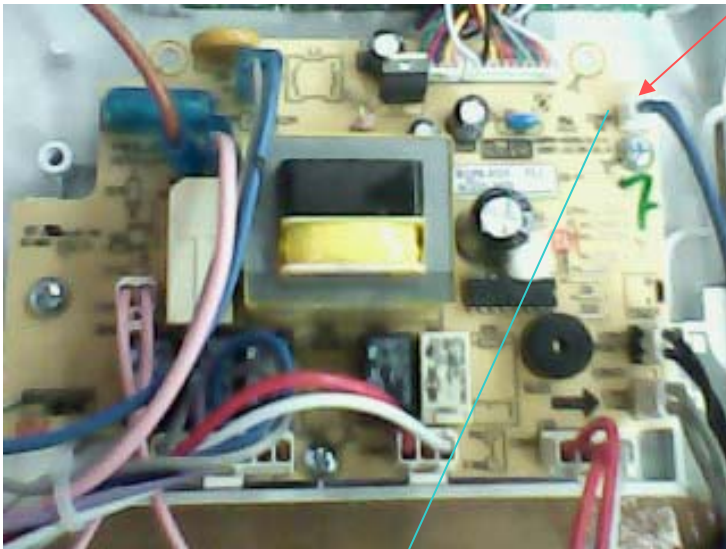

Here marked with "RE"

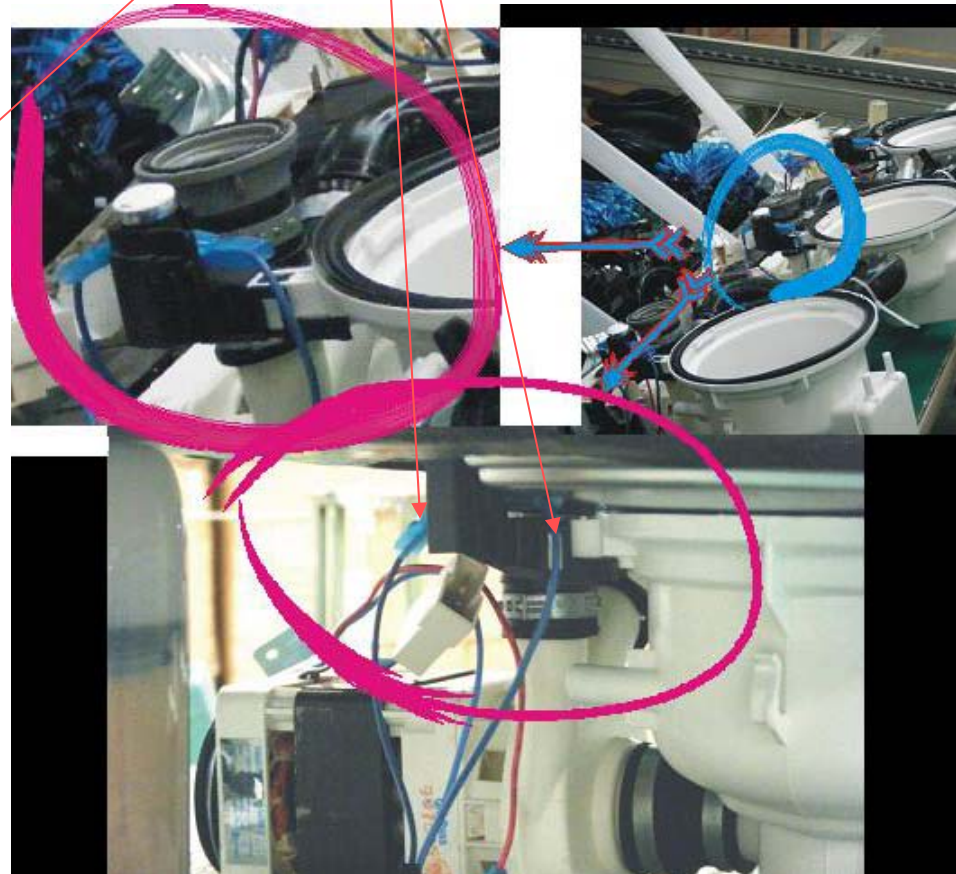



## E7 Alarm

The theory:

If the PCB detect the NTC is short circuit after dishwasher getting electricity, the appliance will cause the E7 alarm.





## E7 Alarm

### Analyse1:

In this case, you can measure the resistance of NTC that must meet the spec(6K $\Omega$ -20K $\Omega$ ). short circuit of NTC will show that NTC has some malfunction. Replace the NTC to resolve this problem. If it is no problem, then Replace the PCB.

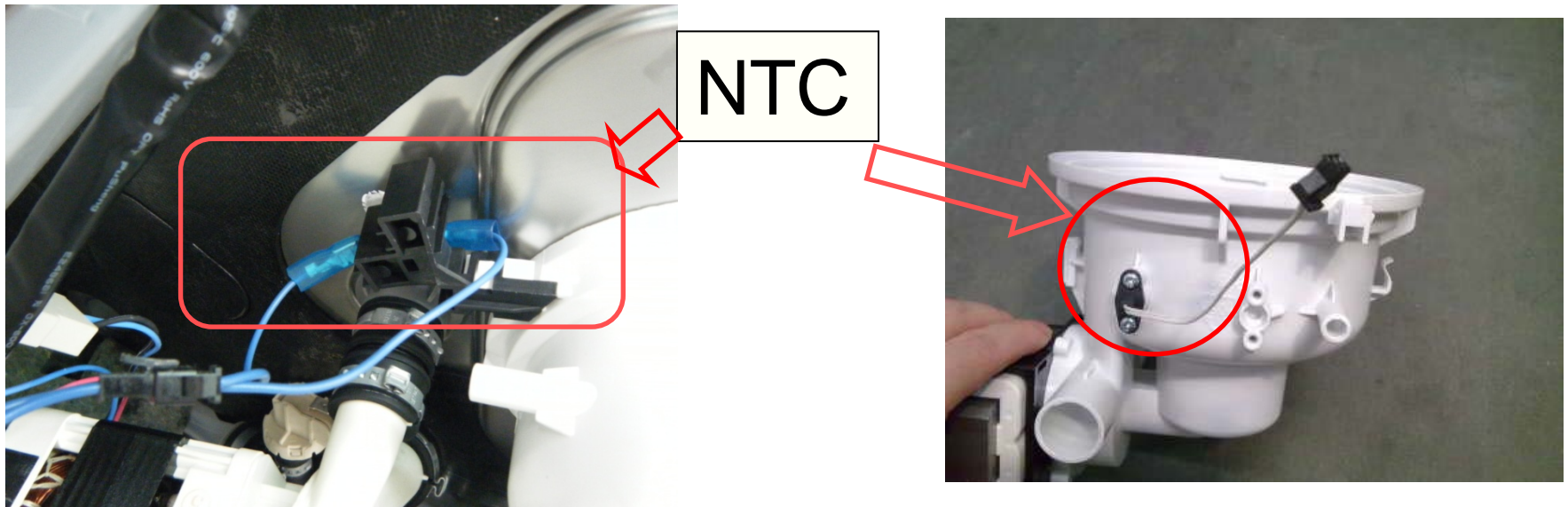



**The end**