



C2342SS

Caple single multifunction oven
Stainless Steel



INSTRUCTION MANUAL

DEAR CUSTOMER,

We thank you and congratulate you on your choice.

This new carefully designed product, manufactured with the highest quality materials, has been carefully tested to satisfy all your cooking demands.

We would therefore request you to read and follow these easy instructions which will allow you to obtain excellent results right from the start.

THE MANUFACTURER

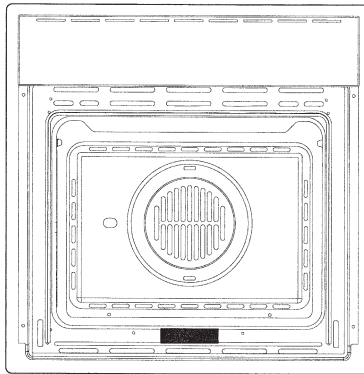

IMPORTANT

The oven's data plate is accessible even with the oven fully installed. The plate is visible simply by opening the door. Always quote the details from it to identify the appliance when ordering spare parts.

CONTENTS

First use	pag. 4
Self-cleaning panel	4
Respect for the environment	5
Control panel	6

INSTRUCTIONS FOR USE:

- conventional cooking	7
- fan cooking	7
- grill cooking	8
Thermostat	9
Cooking timer	9
Electronic timer	10
The control panel	11
Light replacement	22
Removing the oven door	22

INSTALLATION INSTRUCTIONS

Flush fitting	23
Electrical connections	24

THE FIRST TIME YOU USE THE OVEN

Clean the oven thoroughly with soapy water and rinse well. To remove the lateral frames from smooth-walled ovens, proceed as shown in the figure.

Operate the oven for about 30 minutes at maximum temperature to burn off all traces of grease which might otherwise create unpleasant smells when cooking.

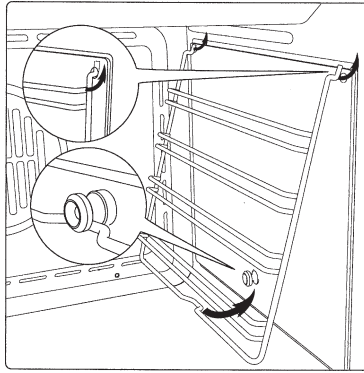

Important:

As a safety precaution, before cleaning the oven, always disconnect the plug from the power socket or the power cable from the oven. Do not use acid or alkaline substances to clean the oven (lemon juice, vinegar, salt, tomatoes etc.). Do not use chlorine based products, acids or abrasive products to clean the painted surfaces of the oven.

SELF-CLEANING CATALYTIC PANELS

Our smooth walled ovens can be fitted with self-cleaning panels to cover the inside walls.

These special panels are simply hooked on to the walls before the side frames are fitted. They are coated in a special, micro-porous catalytic enamel which oxidises and gradually vaporises splashes of grease and oil at cooking temperatures above 200° C.

If the oven is not clean after cooking fatty foods, operate the empty oven for 60 minutes (max.) at maximum temperature.

Never wash or clean self-cleaning panels with abrasive, acid, or alkaline products.

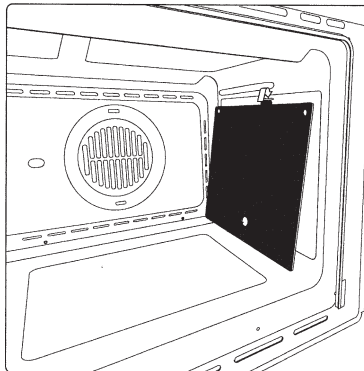

RESPECT FOR THE ENVIRONMENT

The documentation provided with this oven has been printed on chlorine free bleached paper or recycled paper to show respect for the environment.

The packaging has also been designed to avoid environmental impact. Packaging material is ecological and can be re-used or recycled.

By recycling the packaging, you will help save raw materials as well as reducing the bulk of domestic and industrial waste.

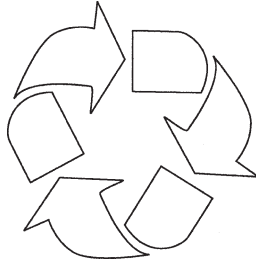

CONTROL PANEL FUNCTIONS

FUNCTION SYMBOLS ON THE SELECTOR



Oven light (stays on while oven is in use).



Bottom heating element.
Thermostat setting from 50°C to MAX.



Top and bottom heating elements.
Thermostat setting from 50°C to MAX.



Top and bottom heating elements with fan.
Thermostat setting from 50°C to MAX.



Circular heating element with fan.
Thermostat setting from 50°C to MAX.



Fan for defrosting.
Thermostat setting at 0°C.



Bottom heating element with fan.
Thermostat setting from 50°C to MAX.



Double top heating element with fan (large area grill).
Thermostat setting from 50°C to 200°C.



Double top heating element (large area grill).
Thermostat setting from 50°C to 200°C.



Top heating element (small, low power grill).
Thermostat setting from 50°C to 200°C.



Bottom heating element + Circular heating element with fan.
Thermostat setting from 50°C to MAX.

INSTRUCTIONS FOR USE

CONVENTIONAL COOKING



Conventional cooking uses top and bottom heat to cook a single dish.

Place the food in the oven only once cooking temperature has been reached, i.e. when the heating indicator goes out.

If you want to increase top or bottom temperature towards the end of the cooking cycle, set the temperature control to the right position. It is advisable to open the oven door as little as possible during cooking.

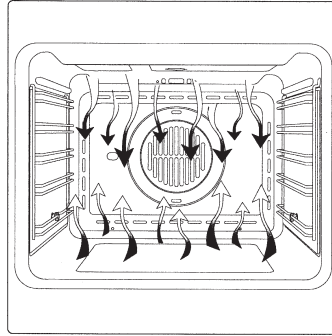

FAN COOKING



For this type of cooking a fan positioned at the back allows the circulation of hot air inside the oven, creating uniform heat. In this way cooking is more rapid than conventional cooking. It is a suitable method for cooking dishes on more than one shelf, especially when the food is of different types (fish, meat etc.)

DEFROSTING



By selecting one of the fan cooking functions and setting the thermostat to zero, the fan allows cold air to circulate inside the oven. In this way frozen food can be rapidly defrosted.

It is not essential to pre-heat the oven, but you are advised to do so when cooking pastries.

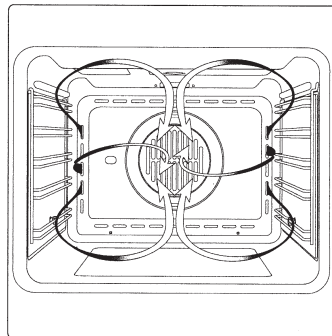

GRILL COOKING



Use the grill to grill or brown foods. **KEEP THE DOOR CLOSED.**

Some ovens may be equipped with an electric motor, spit and skewers for turning on the spit.

Place the shelf with the food to be cooked in the 1st or 2nd position from the top.

Pre-heat the oven for 5 minutes. Turn the thermostat to a temperature between 50° and 200°.

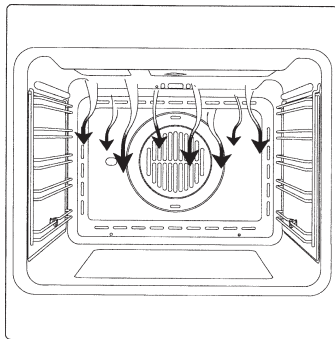

COOLING FAN

The fan is positioned on the upper part of the oven and create a circle of cooling air on the inside of the furniture and through the door of the oven.

It is turned on when the temperature of the outer shell of the oven reaches 60°C.

By switching on the oven with the thermostat at 200°C the fan starts working after approx.10 min.

It is turned off when the temperature of the outer shell of the oven descends under 60°C.

By switching off the oven with the thermostat at 200°C the fan stops working after approx. 30 min.

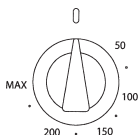

THERMOSTAT

Use the thermostat to set the cooking temperature you need. The thermostat can be adjusted from 50° to 250° C.

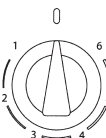
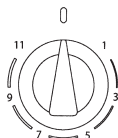

0-11 HEAT REGULATOR

0-6 SELECTOR

Use these to adjust the heat in the cast iron or glass-ceramic plates. Increase the setting from 0 to 6 or from 0 to 11 to raise the temperature.

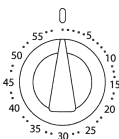

ALARM TIMER

You can set this timer to sound a buzzer after 0 to 60 minutes of cooking. First turn the knob fully clockwise, then turn it back to the desired alarm time.

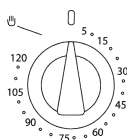

COOKING TIMER

First, turn the cooking selector to the required cooking function, and the thermostat to the desired cooking temperature.

Then, to set *end of cooking time*, turn the cooking timer to the right and to the desired time. First turn the knob fully clockwise, then turn it back to the desired alarm time. A buzzer sounds at the end of the timed cooking period, and the oven switches itself off.

To set only the *start of cooking*, turn the cooking timer to the left to the  symbol.

PROGRAMMING END OF COOKING TIME WITH THE ANALOGUE TIMER

Setting the clock

Pull the knob out and turn it clockwise to set the clock.

First, turn the cooking selector to the required cooking function, and the thermostat to the desired cooking temperature. Then, to set *end of cooking time*, turn the cooking timer to the right and to the desired time. A buzzer sounds at the end of the timed cooking period, and the oven switches itself off. Push the timer knob in to silence the buzzer .

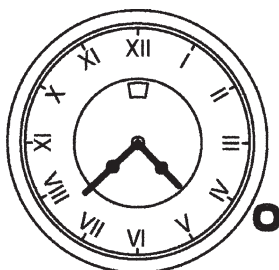

To set only the *start of cooking*, leave the knob in the manual  position.



6 KEY ELECTRONIC TIMER



Setting the clock

Press the duration  key and the end of cooking  key simultaneously, then press the +/- keys to set the time.

MANUAL OPERATION

To start cooking without setting *end of cooking time*, press the manual key .



SETTING ONLY THE DURATION OF COOKING IN SEMI-AUTOMATIC MODE

To set the *duration of cooking*, press the duration key and press the +/- keys to set the duration of cooking. A buzzer sounds when the cooking period finishes, and the oven switches itself off. Turn the thermostat and selector knobs back to 0 position and press the manual key.

SETTING ONLY THE END OF COOKING TIME IN SEMI-AUTOMATIC MODE

To set the *end of cooking time*, press the end of cooking key  and press the +/- keys to set the time at which you want the oven to switch off. A buzzer sounds when the clock reaches the set time, and the oven switches itself off. Turn the thermostat and selector knobs back to 0 position and press the manual key.

FULLY AUTOMATIC OPERATION

To set the *end of cooking time*, press the duration key  and press the +/- keys to set the duration of cooking. Press the end of cooking key  and press the +/- keys to set the time at which you want the oven to switch off.

When you finish setting these times, the AUTO symbol flashes and the buzzer sounds. Press any key to silence it.

ALARM TIMER

Press the alarm timer key and press the +/- keys to set the required duration of cooking. The *buzzer* sounds when the cooking time ends. Press any key to silence it.

PROGRAMMING ERRORS

You cannot program in a cooking period which starts earlier than the time displayed on the clock. If you try to do so, the buzzer sounds and the AUTO symbol flashes. Simply change the duration or cooking time to correct the error.

CANCELLING A COOKING PROGRAMME

To cancel a cooking programme, simply press the manual key.

THE CONTROL PANEL

The panel shown here is purely indicative and may not be identical to the panel on the oven you have purchased.

Depending on the model of oven you have purchased, the *cooking functions* and *temperature functions* may be controlled by knobs instead of keys. The functions themselves are the same for keyboard and knob control ovens.

Temperature display

Time display

Cooking functions

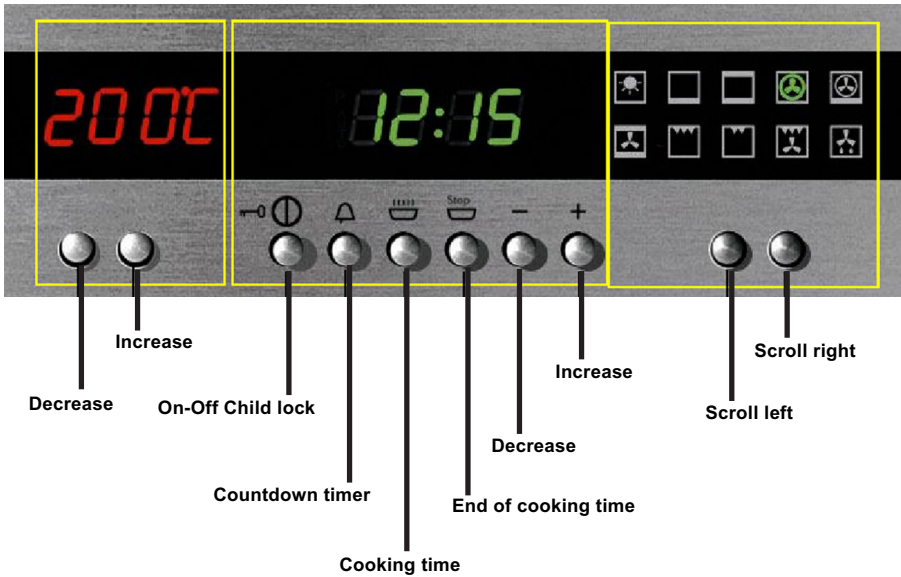

Functions on knob control versions

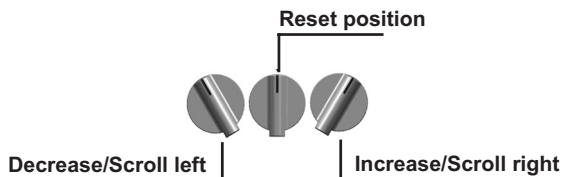

THE FIRST TIME YOU USE THE OVEN

Three zeroes flash on the display the first time you connect the oven to the mains electricity supply, and every time power returns after a power failure. This warns you that you must set the time on the clock before you can select any cooking function.



You must set the time on the clock before you can use the oven.

• Setting the clock

Press the two keys shown below simultaneously to enter clock mode.

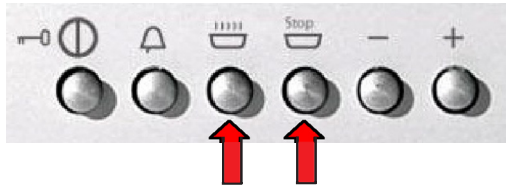

The two dots separating the hours and minutes flash to show you are in clock mode.



Press the + or - keys

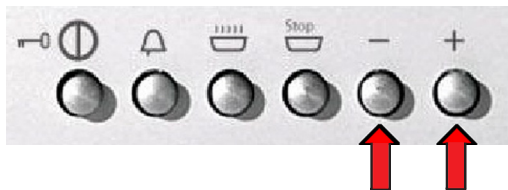

to increase or decrease the time.

After a few seconds the controller sets the time currently displayed and the two dots stop flashing.

Use one of the *cooking functions* to burn off any manufacturing residues from the heating elements and oven walls before actually using the oven to cook food.



Important! If you change the time setting, you reset the timer and cancel all cooking settings.

· Cooking functions

For each cooking function, your new oven's electronic controller suggests a default cooking temperature. This is based on our own experience in obtaining the best results. You can nevertheless change the default value to suit your own requirements.

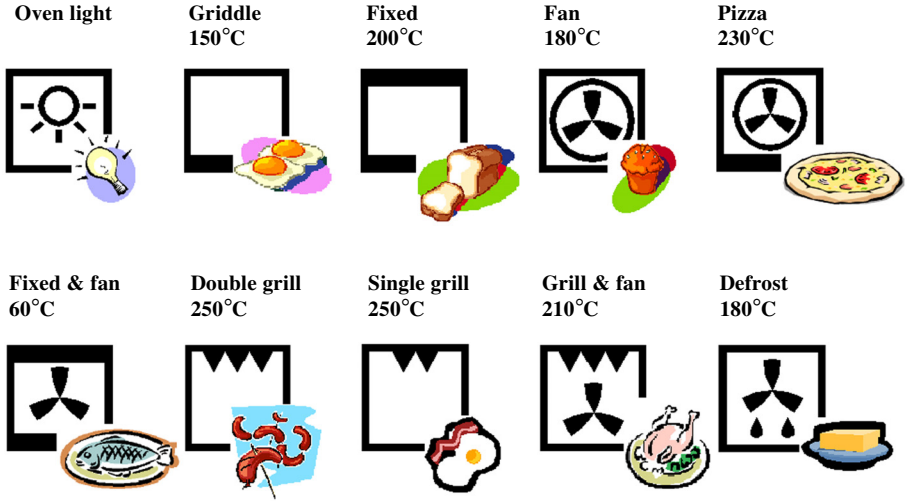

The food types shown are purely indicative of the sort of meal you can prepare with that function. To discover the tremendous versatility of this oven, feel free to experiment with all the functions on the basis of your own cooking experience.

· Cooking

You can start cooking in just a few simple moves.

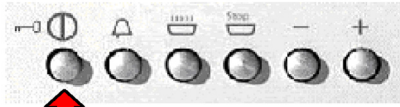

Switch on the oven.

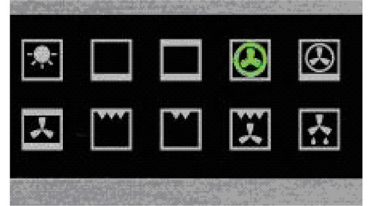

Choose which cooking function you want to use.



Change the default temperature if you wish, or just wait 4 seconds to accept the default temperature.

After 4 seconds the electronic controller automatically switches on the oven. The degrees centigrade symbol flashes to show that the oven is warming up.

The *cooking time* symbol appears on the display to show that the oven is working.



The oven beeps and the degrees centigrade symbol stops flashing when the oven reaches the set temperature. You can now put in the food you want to cook.

Important! The oven switches itself off automatically if you do not select a *cooking function* within 8 seconds of switching the oven on. If this occurs, the *time display* reads “OFF” and the oven beeps to tell you that it has switched off.

• Using the oven light

The oven is equipped with an intelligent light control to reduce electricity consumption. The light stays on while the oven is warming up and for 3 minutes after set temperature is reached, and then switches off.

Press any key to check on the food in the oven. The light comes on for another 3 minutes.

• Child lock

Your new electronic oven has a *child lock* function to prevent young children from tampering with it or accidentally switching it on. You can activate the *child lock* at any time, even when the oven is switched off.

Activating the *child lock*

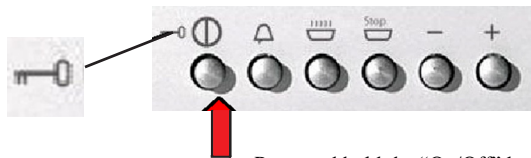

Press and hold the “On/Off” key for at least 3 seconds.

The *time display* shows

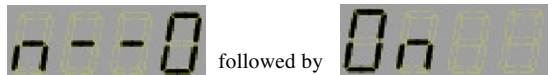

The electronic controller is now disabled. All you can do with the controls is switch the oven off (if it is on) or use the *countdown timer*.



If you press any other key, a key symbol appears on the *time display* or *temperature display* to inform you that the *child lock* is active.



Important! You must deactivate the *child lock* before you can use the oven again.

Deactivating the *child lock*

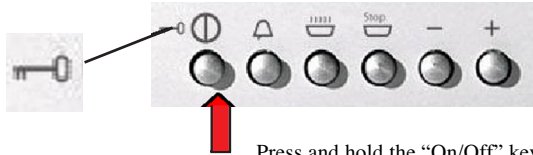

Press and hold the “On/Off” key for at least 3 seconds.

The *time display* shows

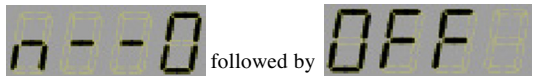

· Using the *time display*

1. Using the countdown timer

The countdown timer works independently of all other timer functions, and can be used as a practical timer with buzzer even when the oven is switched off.



Countdown timer key



The time display appears and the dots separating the hours and minutes flash. Use the “+” and “-” keys to set the countdown period, then simply wait a few seconds for the controller to start the countdown.

The normal *time display* returns with the countdown symbol to show that the countdown is running.



At the end of the countdown time the oven beeps twice at an interval of two seconds and the countdown symbol flashes. Press any key to silence the buzzer. The oven beeps three times and the countdown symbol disappears.

2. Setting *cooking time*

Use the *cooking time* function to set the duration of cooking starting from the present time. You must select a cooking function before you can set *cooking time* (see the “*Cooking*” section).

Oven active: a cooking function has been selected.



Press this key to set *cooking time*.



The time display appears and the dots separating the hours and minutes flash. Use the “+” and “-” keys to set *cooking time*, then simply wait a few seconds for the controller to start timing the cooking period.



The normal *time display* returns with the auto-timer cooking symbol to show that the oven is working.

At the end of the *cooking time* the oven beeps twice at an interval of two seconds and the symbols flash. Then the *temperature display*, the *time display* and the heating elements switch off.

Press any key to silence the buzzer. The oven beeps three times and the symbols disappear.

! If you select no other functions within 8 seconds from silencing the buzzer, the oven automatically switches off.

3. Setting end of cooking time

Use the *end of cooking time* function to set the time at which you want cooking to finish. You must select a cooking function before you can set *end of cooking time* (see the “*Cooking*” section).

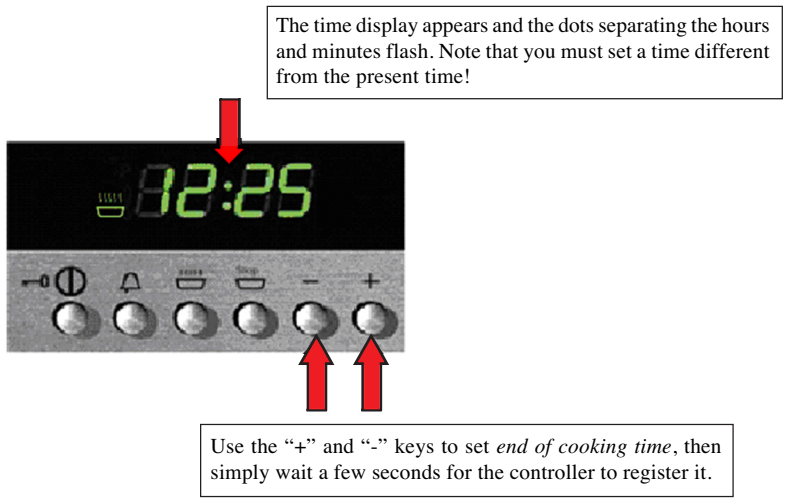
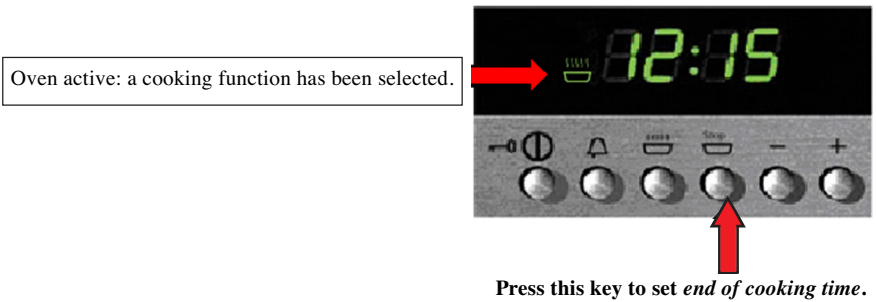



The normal *time display* returns with the auto-timer cooking symbol to show that the oven is working.

At the *end of cooking time* the oven beeps twice at an interval of two seconds and the symbols flash. Then the *temperature display*, the *time display* and the heating elements switch off.

Press any key to silence the buzzer. The oven beeps three times and the symbols disappear.

! If you select no other functions within 8 seconds from silencing the buzzer, the oven automatically switches off.

4. Setting cooking start and end times

You can combine the *cooking time* and *end of cooking time* functions to set the start and end times for cooking. In this way you can program your electronic oven to cook while you are out or to defrost foods ready for you to cook when you get back. A great help in the kitchen!



The order in which you set the two functions is not important.



Example: We want to start cooking a dish 30 minutes before we get home so that it will be ready for us when we do.

Place the dish in the oven and select the cooking function you want (*Grill + fan* shown by way of example only). Adjust the default temperature as required.



Set a cooking time of 30 minutes.

Set the *cooking time* (see section 2. Setting *cooking time*).



Before you set *end of cooking time*, note the present time.



When you set *end of cooking time*, the timer display present time plus *cooking time* by default.

Use the “+” key to set a time e.g. 10 minutes later. The timer registers this time after a few seconds. The display switches off and the oven enters stand-by mode. The present time is displayed.



At 12:25, the oven switches on in *Grill + fan* mode for 30 minutes, and switches off at 12.55 according to our time settings.



- **Hint!** This is a good time to activate the *child lock* to prevent young children from tampering with or accidentally switching on the oven.



REPLACING THE OVEN LIGHT

IMPORTANT:

The oven light must have these precise features:

- a) it must be able to resist high temperatures (up to 300°C)
- b) power supply: see V/Hz indicated on data plate.
- c) power 25W.
- d) E 14 connection.

Before proceeding, disconnect the appliance from the main electricity supply.

- to prevent damage, place a tea cloth in the oven
- unscrew the glass cover of the light
- unscrew the old light bulb and replace it with the new one
- put back the glass cover and remove the tea cloth
- connect the appliance to the main electricity supply

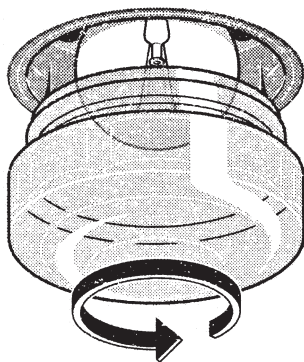

REMOVING THE OVEN DOOR

The oven door can be removed quickly and easily. To do so, proceed as follows:

- Open the door fully.
- Lift the two levers shown in fig.
- Close the door as far as the first stop (caused by the raised levers).
- Lift the door upwards and outwards to remove it from its mountings.

To replace fit the door, fit the hinges in their mountings and lower the two levers.

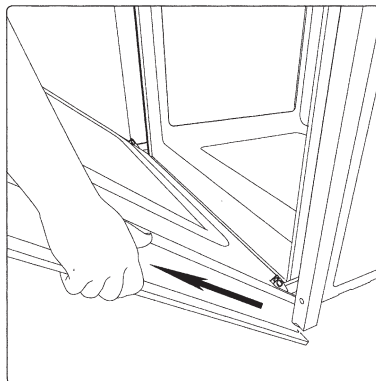
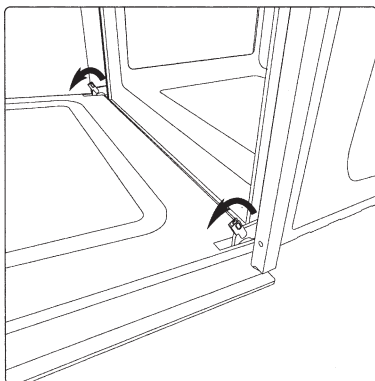

INSTALLATION INSTRUCTIONS

Flush fitting

The oven can be installed under a work top or in a cooking column. Figure shows the installation dimensions.

Make sure that surrounding materials are heat resistant. Align the oven centrally with respect to the side walls of the units surrounding it and fix it in place with the screws and Allen screws provided.

See the accompanying instructions for combining the oven with multi-functional gas or gas-electric cookers.

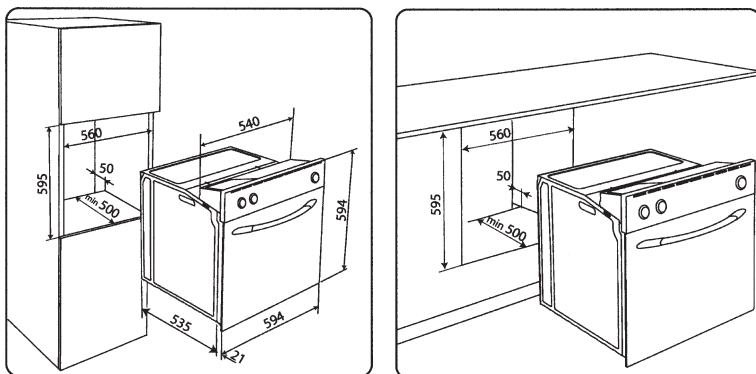

GAS OR ELECTRICAL CONNECTIONS

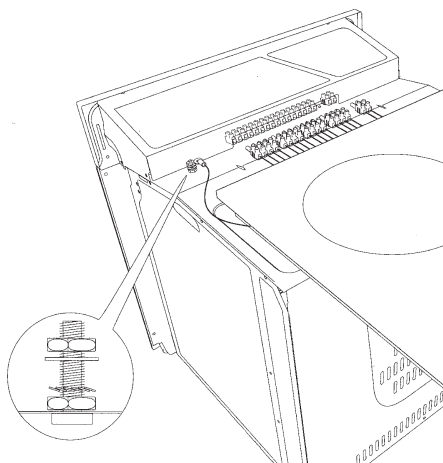
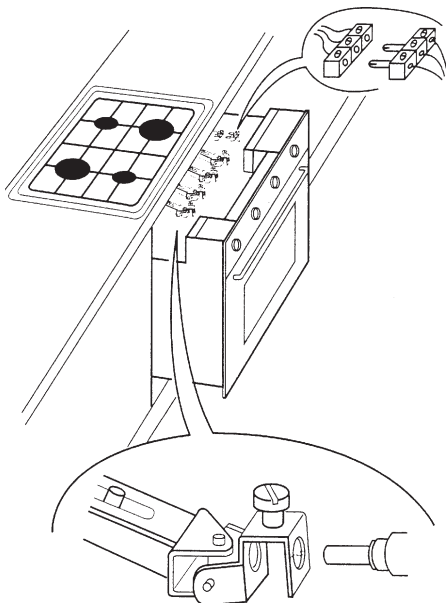

ELECTRICAL CONNECTIONS

Before connecting the oven to the mains power supply, make sure that:

- The supply voltage corresponds to the specifications on the data plate on the front of the oven.
- The mains supply has an efficient earth (ground) connection complying with all applicable laws and regulations. Correct earthing (grounding) is a legal requirement. If the appliance is not pre-fitted with a power cable and/or plug, use only suitable cables and plugs capable of handling the power specified on the appliance's data plate and capable of resisting heat. The power cable should never reach a temperature 50° C above ambient temperature at any point along its length. If the appliance is to be connected directly to mains terminals, fit a switch with minimum aperture of 3 mm between the contacts. make sure that the switch is of sufficient capacity for the power specified on the appliance's data plate, and compliant with applicable regulations. The switch must not break the yellow-green earth wire. The socket or switch must be easily reachable with the oven fully installed.

N.B. The manufacturer declines all responsibility for damage or injury if the above instructions and normal safety precautions are not respected.

* **CABLE TYPES AND DIAMETERS** 230V~ H05RRF 3 x 1,5 mm²

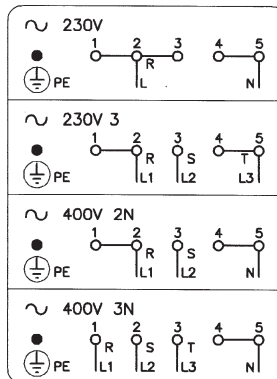
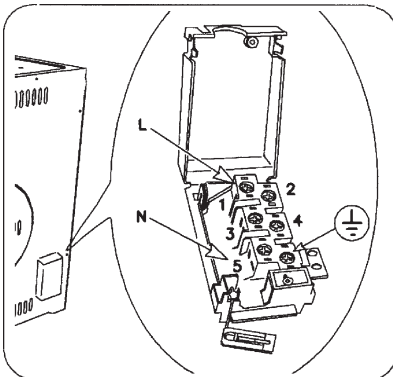
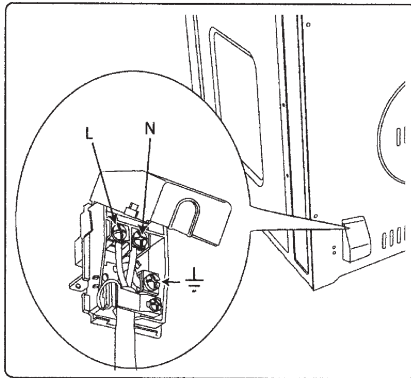

* **H05RN-F**

The manufacturer declines all responsibility for possible inaccuracies contained in this pamphlet, due to printing or copying errors. We reserve the right to make on our own products those changes to be considered necessary or useful, without jeopardizing the essential characteristics.

COD. 2.000.74.1

TIMER TOUCH CONTROL



Setting the clock



Figure 1

“Auto” and “0:00” will start flashing when the unit is switched on for the first time. To set the clock, press the central button for about 3 seconds. When  appears, press “+” or “-” to set the correct time.

Wait until a beep tells you that the clock has been set (figure 1).

To set the time at a later stage, press “+” and “-” together for 3 seconds and then adjust the clock as described above.

Minute counter



Figure 2

As this minute counter does not control the oven, when it finishes counting the oven will continue to work.

To set, press the central button for 3 seconds until  appears (figure 2). Press “+” and “-” to set the required time.

To set the minute counter at a later stage, press the central button for 3 seconds and adjust as described above.

The minute counter beeps when it finishes counting. To disable it, press any button.

Cooking time



Figure 3

This is a semi-automatic cooking function. It can be used to set cooking times.

Press the central button for 3 seconds. Then press it again until “dur” appears (figure 3). Press “+” and “-” to set the required cooking time.

End of cooking time



Figure 4

The end of cooking time can also be set.

Press the central button for 3 seconds. Press the central button twice consecutively and wait for "End" to appear (figure 4). Press "+" and "-" to set the required end of cooking time.

The oven will work in the set mode and at the set temperature until the end of cooking time.

Programming automatic cooking



Figure 5

Cooking function with set times.

Press the central button for 3 seconds. Then press it again until "dur" appears. Press "+" and "-" to set the required cooking time. Wait a few seconds for the setting to be memorised.

Press the central button for 3 seconds. Press it another two times and wait for "End" to appear (figure 4). Press "+" and "-" to set the required end of cooking time.

E.g.:

Current time: 12.30

Cooking time: 10 minutes

End of cooking time: 14.00

The oven will start cooking at 13.50 (14.00 less 00.10) at the set temperature and in the set mode and will stop at 14.00

The oven will beep when it stops cooking. To disable it, press any button.

Adjusting beep volume



To adjust beep volume, press "+" and "-" together. Then press the central button and wait for "ton1" (high volume) to flash. Press "-" to select "ton2" (medium volume) or "ton3" (low volume). Press the central button to set the selected volume.