

USER INSTRUCTIONS



FULLY INTEGRATED FROST-FREE FRIDGE-FREEZER

Ri552FF



CE DECLARATION OF CONFORMITY

The manufacturer of the product/s described herein, to which this description refers, declares on its sole responsibility that the product/s meet the relevant fundamental safety, health and protection requirements of the relevant EU guidelines and that the corresponding test reports are available for examination by the relevant authorities and can be requested from the seller of the appliance, especially with regard to **CE Declaration of Conformity** issued by the manufacturer or with the manufacturer's approval.

Moreover, the manufacturer declares that the parts of the appliance described in this user manual, which come into contact with fresh food, do not contain any toxic substances.

Your 1st Year Guarantee

Your appliance carries a 12 months parts and labour warranty. To fulfil the conditions of your guarantee, the appliance must be correctly installed and operated, in accordance with the instructions, and only be used for normal domestic purposes.

Please note that the guarantee, and service availability, only apply to the United Kingdom.

Customer Service

In case of difficulty please call the Customer Service Helpline on

0870 850 2234

Please ensure you have the model and serial number to hand when calling customer service. Please keep your receipt or invoice in a safe place as they will be required as proof of date of purchase.

Ri552FF

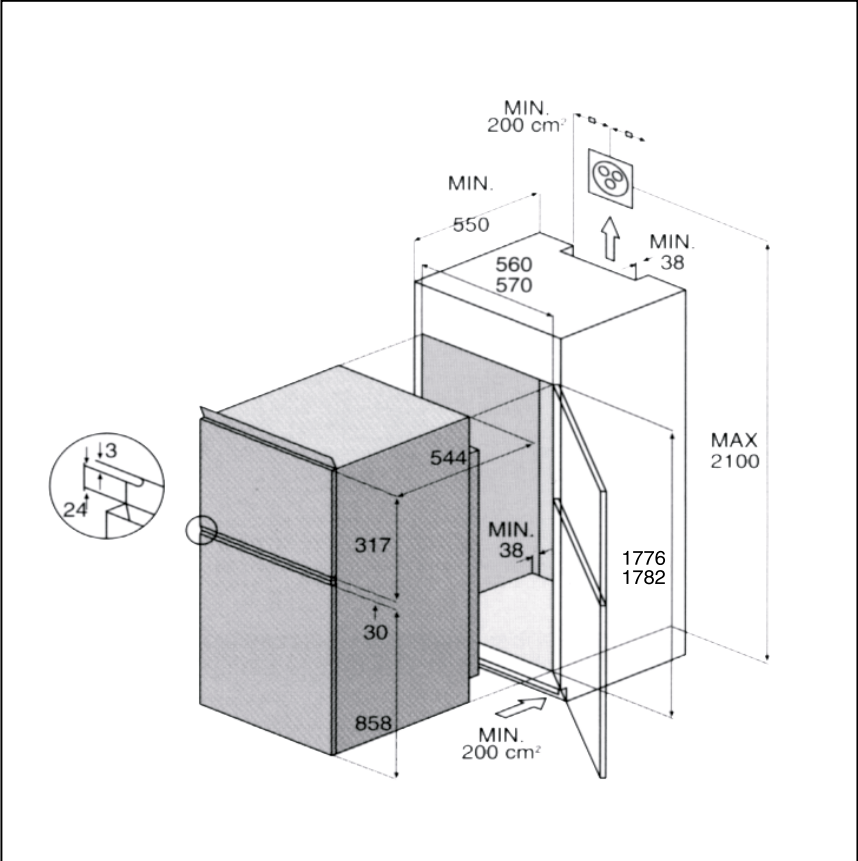

Contents

Cautions-----1~2
Refrigerator diagram-----3
Location-----4
Preparation-----5~7
Functions-----8~9
Operation-----10
Refrigerator storage-----11
Cautions-----12
Suggestions-----13
Freezer storage-----14
Cautions-----15
Defrosting,Cleaning and Cesstion-----16~19
Questions and Answers-----20~22

Cautions

Disposal of the old appliance

Before disposing an old appliance, please make sure it's inoperative and safe. Unplug the appliance and remove or destroy all of the springs, latches, or bolt-locks in order to avoid the risk of child entrapment.

It must be noted that the refrigeration system contains insulating gases and refrigerants, which require specialized waste disposal. The valuable materials contained in a refrigerator can be recycled. Contact your local waste disposal center for proper disposal of an old appliance and contact your local authority or your dealer if you have any question. Please ensure that the pipe work of your refrigerator does not get damaged prior to being picked up by the relevant waste disposal center, and contribute to environmental awareness by insisting on an appropriate, any-pollution method of disposal.

Disposal of the packaging of your new appliance

All the packaging materials employed in the package of your new appliance may be disposed without any danger to the environment.

The cardboard box may be broken or cut into smaller pieces and given to a waste paper disposal service. The wrapping foil is made of polyethylene and the polyethylene pads and stuffing contain no fluorochloric hydrocarbon.

All these valuable materials may be taken to a waste collecting center and used again after adequate recycling.

Consult your local authorities for the name and address of the waste materials collecting centers and waste paper disposal services nearest to your house.

Safety Instructions and Warnings

Before starting the appliance, read the information given in the User's Guide carefully.

The User's Guide contains very important observations relating to the assembly, operation and maintenance of the appliance.

Keep the User's Guide in a safe place and remember to hand it over to the subsequent owner, if you ever sell the appliance.

The manufacturer does not accept responsibility for any damages that may arise due to non-observation of the following instruction.

Cautions

- *Damaged appliances are not to be put into operation. In case of doubt ,consult your supplier.
- *Connection and installation of the appliance are not to be carried out in strict compliance with the relative instructions set forth in the Use's Guide.
- *For the purpose of safety ,the appliance must be properly grounded in accordance with specifications.
- *The plug should be accessible after the appliance positioned.
- *Power cable should inly be replaced by factory authorized service shop.
- *Always remember to unplug the appliance before cleaning.To disconnect the appliance, pull at the plug itself not the cord.
- *Keep alcoholic beverages in airtight bottles or containers and always store in an upright position. In addition, do not store any explosive substances inside the appliance-**Danger of explosion!**
- *Do not damage any parts of the appliance that carry refrigerant by piercing or perforating the refrigerant's grooves with sharp or pointed items,crushing or twisting any tubes, or scraping the coatings off the surfaces. If the refrigerant spurts out and gets into eyes, it may result in serious eye injuries.
- *Do not obstruct or cover the ventilation grille of the appliance.
- *Do not allow children to play with the appliance. In no case should children be allowed to sit on the drawers or hang onto the door.
- *After installation of the appliance the plug should be easily accessible.
- *If the power cable is damaged, an approved cable provided by a manufacturer or a service agent must be used for replacement.
- *Warning: Keep the appliance well ventilated; remove any transport supports from cavity.
- *Warning: Do not use hard objects to remove frost.
- *Warning: Ensure the refrigeration pipeline cannot be damaged.
- *Warning: Do not use electric appliances within the food storage compartment except for models recommended by the manufacturer.

Specifications

- *This appliance is designed for food refrigeration, ice making and frozen food storage.
- *It is intended strictly for household use. If using it for industrial or commercial purpose , be sure to observe the relevant norms and regulations.
- *The refrigerating circuit is leak-proof.

Refrigerator Diagram

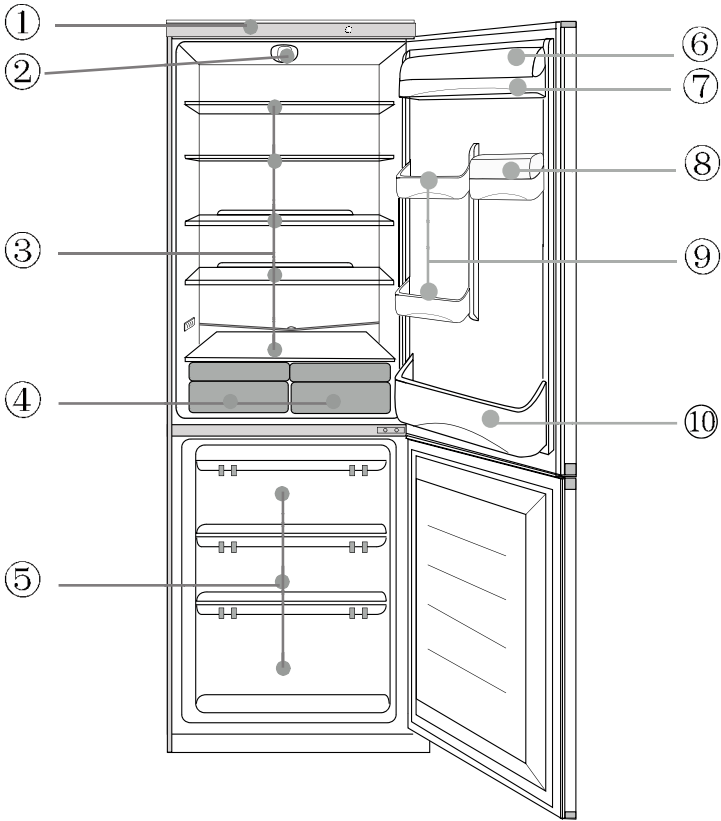

- ① Control panel
- ② Lamp
- ③ Food shelf
- ④ Fresh food container
- ⑤ Drawers
- ⑥ Low bottle holder cover
- ⑦ Low bottle holder
- ⑧ Small bottle holder cover
- ⑨ Small bottle holder
- ⑩ High bottle holder

This diagram may vary slightly with the layout of the refrigerator you have just purchased due to technical improvements.

Location

*The refrigerator should be placed on a flat and solid surface. If the refrigerator is placed on a plinth, flat, strong and fire-resistant materials must be used. The front black foot of the refrigerator can be adjusted clockwise or anti-clockwise to lift or lower the refrigerator if it is placed on an uneven surface.

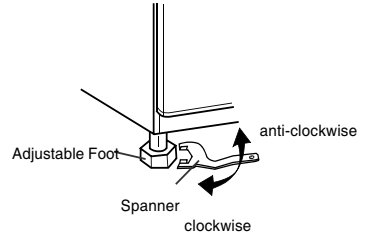

*Prevent the refrigerator from heat sources or direct sunlight.



*The area for built-in refrigerator should be well ventilated with a space over 6cm around the refrigerator.

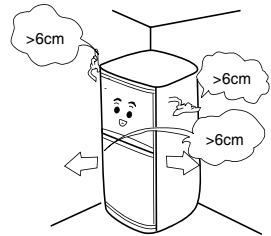

*Never place the refrigerator near to a water source. Clean and dry any water splashes and stains with soft cloth.

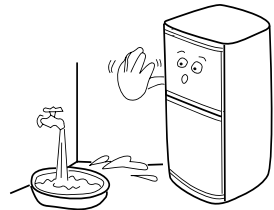

*Never place the refrigerator in an area with an ambient temperature below zero. Never operate the refrigerator in an open area.

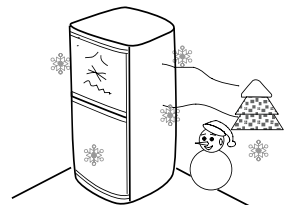

Preparation

1. Unpacking

Remove all packing materials.

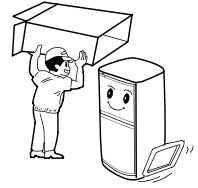

2. Check attached accessories and materials.

Checking should be conducted with reference to the Packing List. Contact the local distributor if shortage is found.



3. Ensure that the refrigerator is properly located.

(Refer to the section of "Location")

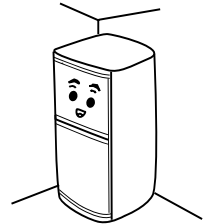

4. Clean the refrigerator before using.

(Refer to the section of "Cleaning")



5. Standby status

Connect the power source a minimum of 30 minutes after the refrigerator has been sited and cleaned.

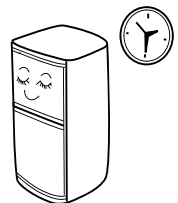

Caution:

After unpacking, write down the model and delivery number of the refrigerator on the Warranty for future inquiries.

Preparation

Left/Right Door Opening

The door of the refrigerator can be opened both from the left or right as required. The following are the steps required to position the door to open to the right.

1. Firmly hold the refrigerator door and remove the screws from the right lower hinge. Remove the door and place aside. Remove the lower pivot pin and install it in the left lower hinge hole.

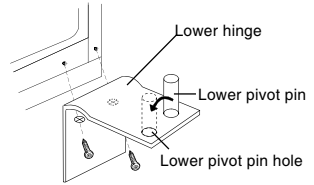

2. Remove the middle hinge and the washer on the middle connection and then the freezer door. Put the door aside.

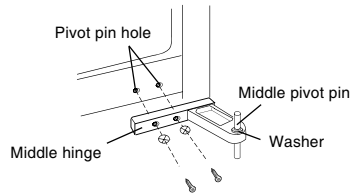

3. Remove the upper right hinge cover and the hinge screws. Install the right upper hinge cover.

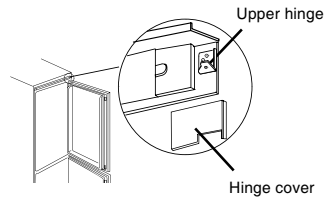

4. Fix the left upper hinge to the left side and then the left upper hinge cover.

5. Mount the refrigerator door to the left of the housing with the middle hinge connected.

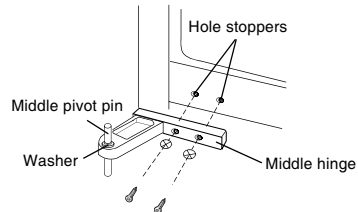

6. Mount the refrigerator door with the top left hole on the down pivot pin of the middle hinge.

7. After installation, open and close the door several times and fix tighten the hinge screws when the door operates normally.

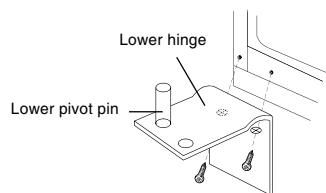

Preparation

Built-in installation

1. Ensure that the doors of the kitchen unit and the refrigerator are of the same opening direction. (Take the right-opening door as an example)

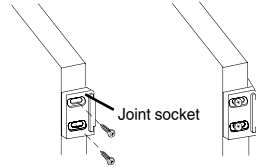

(Figure 1)

2. Fix the joint sockets to the freezer and refrigerator doors with the provided screws (Figure 1).

3. Move the refrigerator into the kitchen unit, ensuring the left side panel of the refrigerator as close as possible to the wall. (Figure 2)

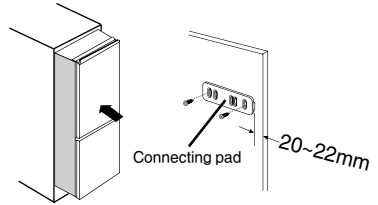

(Figure 2)

(Figure 3)

4. Insert the connecting pad into the joint socket and then fix the connecting pad on the door of the kitchen unit with a margin of 20-22mm. (Figure 3)

5. Properly place the refrigerator with a 3-4mm space between the left side to the wall, ensuring that the doors of the refrigerator and the kitchen unit can be easily opened and closed, and the connecting pad is correctly settled in the joint socket.

6. Fix the upper and lower stiffeners to the upper connection and base panel. The screw holes shall be plugged with the plastic stoppers. (Figure 4)

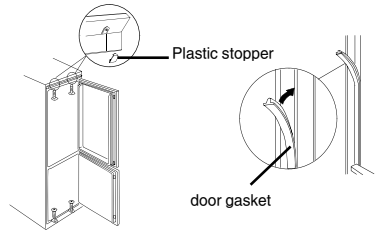

(Figure 4)

(Figure 5)

7. Fill the left gap of the kitchen unit with the gasket. (Figure 5)

8. Remove the screws and the hole stoppers on the left of the middle connection, and fix the connecting pivot to the refrigerator with one end in the hole which was plugged by the stopper and the other end to the inside wall of the kitchen unit. (Figure 6)

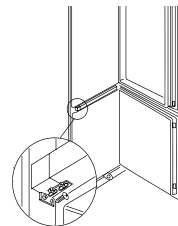

(Figure 6)

Functions

1 Control panel

When refrigerator is connected a power source, the green lamp (E) and the red overtemp warning lamp (G) illuminate.

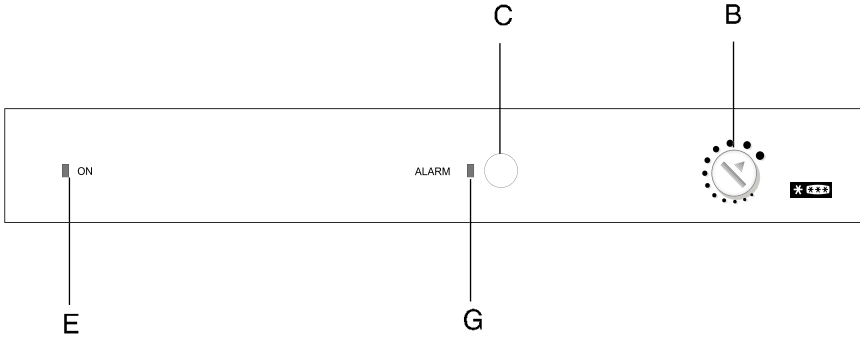

B. Temperature setting

C. Buzzer release

E. Power indicator (green)

G. Over temperature indicator (red)

2 Power indicator

The power indicator will illuminate after the appliance is connected to the power resource.

3 Temperature settings

Turn the temperature knob "B" to set temperatures of the refrigerator. With the value increasing, the temperature goes down and vice versa.

4 Over temperature warning and buzzer release

When the actual temperature as sensed is above set point, the over temperature warning indicator G will blink accompanied by a buzzing. Check to see if the refrigerator door is properly closed or if the refrigerator is first operated. When the temperature in the freezer compartment falls to the desired value, the red over temperature-warning indicator will automatically extinguish. When the refrigerator is first used, the indicator G illuminates.

Pressing the button C will cease the activated over-temp buzzer. When the temperature in the freezer falls down below -5°C , the over-temp warning indicator will extinguish

Functions

5 Forced defrosting

Pressing the button C for 5 seconds, it will enter the forced defrosting mode. Then the machine defrosts, after 20 seconds over.

6 Error indication

Temperature sensors are installed in the refrigerator and the freezer.

The red warning lamp will blink if problems occur with the refrigerator temperature sensor,

Contact authorized after-sales service if the sensors have problems while the cooling system of the refrigerator functions.

Operation

1 Connect the refrigerator to the power supply.

After connection of the power supply, the green indicator illuminates and the refrigerator operates. The red warning indicator might illuminate once in a while and automatically extinguishes when the set temperature in the refrigerator is reached.

2 Temperature setting

Temperatures in the refrigerator and the freezer are controlled by the thermostats. With the value increasing, the temperature goes down and vice versa.

3 Loading the food

Load the refrigerator with food a few hours after the refrigerator is turned on.

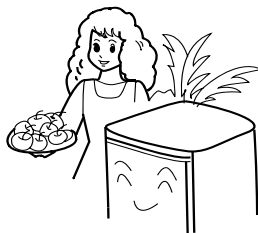

Caution: Some time will be required for the refrigerator to reach the set level when temperature adjustments are made. The length of this period is determined by difference in the existing and set temperatures, the ambient temperature, the frequency with which the door is opened and closed and the amount of food in storage.

Refrigerator storage

The refrigerator is for short-term food storage or for daily consumption.

Although the temperature in most areas in the refrigeration compartment can be regulated between 0°C and 10°C, extended periods of food storage is not recommended. Refrigerator should only be used for short-term storage.

Refrigeration compartment

As cold air circulates inside the refrigerator, temperature differences exist inside the storage compartments. Area ⑥ is the coldest. Different foods should be placed in different areas according to their properties.

1. Eggs and butter
2. Canned food and seasonings
3. Beverages and bottled food
4. Pickled food or canned pickled food
5. Wheaten food, canned food, milk and beancurd
6. Cooked food and sausages
7. Fruit, vegetables and salad

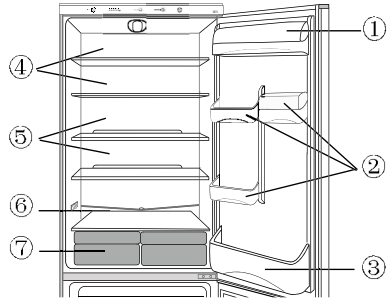

Relocation of the food shelves

Carefully remove and replace the food shelves for desired height and space.

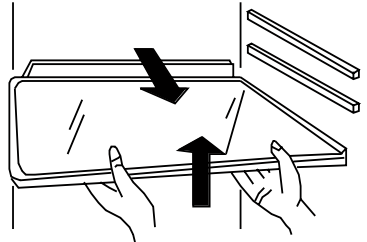

Lamp and its replacement

Lamp: 240V~, 15W

Lamp holder: E14 (lamps exceeding 15W must not be used)

When replacing the lamp

- Unplug the appliance.
- ① To release the lampshade, depress the clip at the back along the arrow; ② Hold both sides of the lampshade and push ensuring that the lugs are freed from the square slots of the lamp holder.
- Rotate the lamp anticlockwise for removing and clockwise for installing.
- When replacing the lampshade, ensure that all the lugs of the lampshade are settled into the slots of the lamp holder.

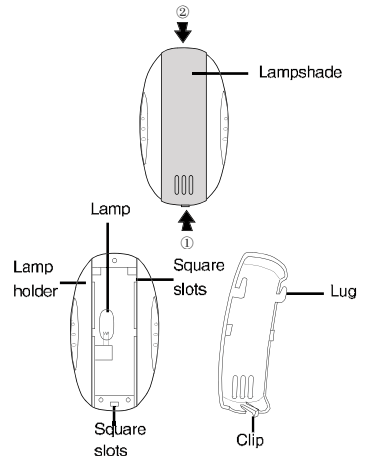

Cautions

*Hot food must be cooled to room temperature before storing in the refrigerator.

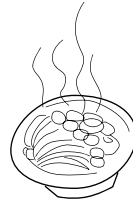

*Dry any water droplets on the food before placing it in the refrigerator.



*It is recommended that food be sealed in suitable storage bags before placing it in the refrigerator. This will prevent moisture in the food from evaporating and prevent vegetables and fruit from withering or altering in flavor.



*Storage of Sorted Food

Food to be stored should be sorted according to consumer requirements. Food consumed daily should be placed in the most convenient area, this will minimize opening periods for the door.

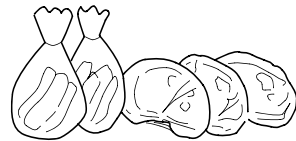

*Do not store excess quantities or weights of food
Food should be stored with spaces in between for better storage results. Never overload shelves, as they may collapse under excessive loads.

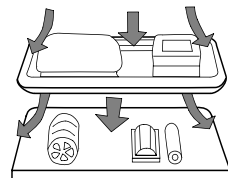

*Do not place food too close to the internal walls. The stored food placed close to internal walls is easily frozen onto the walls.

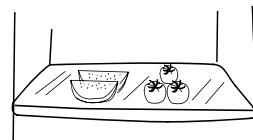

Suggestions

*Storage period will be extended if vegetables are placed with their roots towards the cold source.

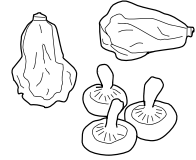

*Leaves of carrots or turnips should be removed before storage.

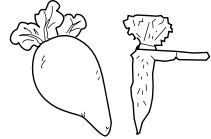

*Eggs should be stored vertically in the egg holder.

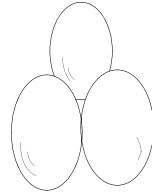

*Frozen food can be placed in the cold compartment before serving, as this will conserve energy.



*Onions, garlic, ginger, water chestnuts and other root vegetables should not be stored in the refrigerator, as these foods are suitable for long-term storage at normal temperatures.



*Ripe squash, melon, pawpaw, bananas and pineapples should not be stored in the refrigerator. Freezing will accelerate the ripening process.

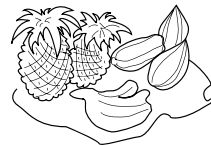

Caution: If the ambient temperature in winter is between 0°C and -10°C , and the refrigerator temperature is low and the temperature in lower section of the refrigerator is around 0/, place the fresh food on the top area of the refrigerator.

Freezer storage

Long-term storage of food

As the freezer storage temperature is very low, fresh food can be stored in the freezer compartment for a long time. Food requiring long-term storage can be stored in the frozen food compartment. Attention should be paid to the storage information printed on the food packing.

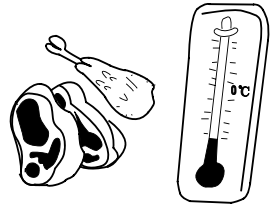

Making water-ice

- *Pour water into the water ice mould up to three-quarters of the mould volume, and then place the mould in the freezing compartment.
- *Do not use a knife or other metal tools to take the ice out of the mould.
- *The ice can be easily removed by hand after the mould has been placed in warm water for a short time.

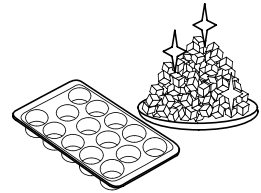

Do not load excessive food

Quantity of fresh food to be loaded is subjected to the capacity of the refrigerator. (refer to the requirements on the nameplate)



Cautions

*Hot food should not be stored in the refrigerator until it has cooled down to room temperature.

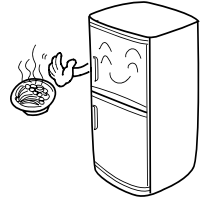

*Food cut into small portions will freeze faster and be easier to defrost and cook. The recommended weight for each portion is less than 2.5kg.



*The outside of any food packing should be dried before storage in the freezer, and any packing materials should be odor-free, airtight, non-poisonous and nontoxic.

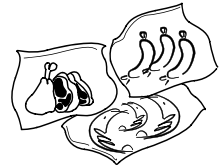

*Food should be stored in accordance with any information printed on the packing.

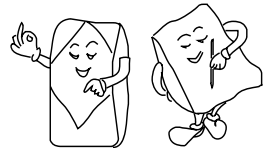

*Only remove the required amount of food from the refrigerator. Defrosted food cannot be re-stored in the freezer unless it is first cooked.

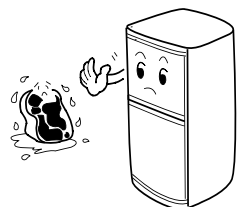

Defrosting

Defrosting the refrigerator

The refrigerator is designed for automatic defrosting. Frost formed on the back wall will melt and flow via the drainpipe to the evaporating container over the compressor on the back of the refrigerator, where the heat generated by the compressor will evaporate the water. It is normal for frost and water droplets to form on the back wall of the freezer.

Water Outlet

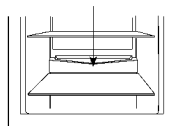

Cleaning Rod

Caution: Always keep the drain over the vegetable and fruit tray clear to ensure the normal flow of defrosted water. Use the pin provided to clear any blockages.

Defrosting the freezer

The frost free system completely eliminates the need for defrosting. Air is circulated around the freezer via a fan, removing moisture from the compartment.

Cleaning

Cleaning

The refrigerator should be cleaned regularly to prevent the formation of bad odors.

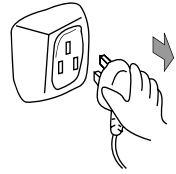

*Disconnect the power before cleaning the refrigerator.

*Clean the refrigerator with soft towel or sponge wet with warm water. (mild detergent)



Caution: Do not use a hard brush, steel brush, detergent, gasoline or other solvents, hot water, acid or alkali for cleaning.

* Dry water drop on the surface of the refrigerator with a soft cloth.



Caution: Do not use excessive amounts of water for cleaning the refrigerator. Use a dry cloth to clean the switch and the lamp.

*Clean the back and sides of the refrigerator regularly.

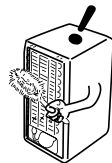

*Always keep the door gasket clean.



Cessation

Power failure

Even in summer, food can be stored in the refrigerator for a few hours after a power failure.

*Don't put additional food into the refrigerator during a power failure.

*If prior notice of a power failure is given, make some ice and put it in a container in the top of the cold storage compartment.

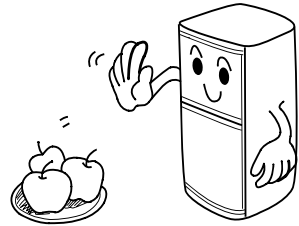

Caution: Temperature in the refrigerator will rise during a power failure or in the event of technical problems, and the storage period will be reduced.

Operation cessation

*If the power failure lasts for an extended period, unplug the refrigerator and clean the refrigerator as previously described.

*Keep the door of refrigerator open when the power is turned off to prevent any food remaining in the compartment from producing bad odors.

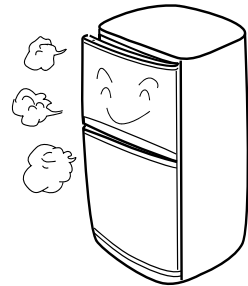

Caution: It is recommended that the refrigerator is not turned off.

Caution: The refrigerator should never be restarted until a period of at least five minutes has elapsed.

Cessation

During Vacations

*Remove the food from refrigerator if the vacation is short. Turn the temperature selection knob to the proper position, and make sure that the door of the refrigerator is properly closed.

*If the vacation is long, take out the food from the refrigerator and disconnect the power. Wait until the frost inside melts, clean and dry the compartment. Leave the door open to prevent formation of bad odor.

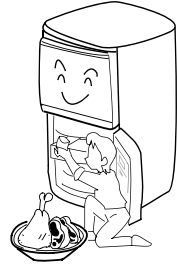

Moving the refrigerator

*Unplug the refrigerator.

*Remove all the food.

*Secure the shelves and the fresh food container with the tape.

*Tightly close and tape the door of the refrigerator.

*Do not tilt the refrigerator more than 45 degrees, thus problems may be resulted to the cooling system.

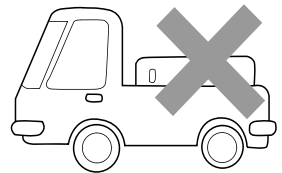
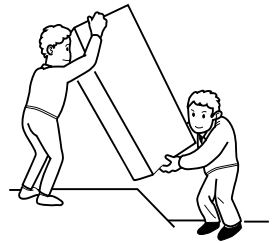

Caution: never place the refrigerator horizontally.

Questions and Answers

Following circumstances are not problems:

- *A slight sound might be produced by the evaporator and the pipes due to temperature changes.

- *The compressor will operate for comparatively longer periods if excessive quantity of food is stored or the ambient temperature is high.

- *A slight sound might be produced by the thermostat, start capacitor or heat protector when the appliance is first started.

- *Wipe with soft cloth the water drops, which might appear on the external surface and the middle connection of the appliance.

- *The two sides of the external surface and the middle connection of the appliance will be warm due to heat radiation of the appliance.

- *A slight sound may be heard when the appliance is first started due to the operation of the compressor and motor. The sound will be lower and lower gradually a short period later.

- *The temperature of the refrigerator and the compressor will rise and the compressor will run for comparatively longer periods when the refrigerator is first started.

Questions and Answers

Following circumstances are not problems:

*A slight continuous sound will be heard when the liquid refrigerant circulates.

*Excessive vibration will be resulted in the following circumstances:

- a) The refrigerator is not well positioned and adjusted.
- b) The refrigerator is placed on a wood floor or near to wooden furniture.

*Electricity consumption specified in the technical parameters is the standard issued by state authorities. This is determined under the following operating conditions for the refrigerator: ambient temperature: 25 degrees Centigrade; temperature in the cold storage compartment: 5 degrees Centigrade; Door: closed; continuous operation: 24 hours.

*When the ambient temperature and humidity are high (exceeding 32 degrees Centigrade and 75%, respectively), a thick layer of ice will form on the back wall of the cold storage compartment. In such circumstances, it is recommended that automatic mode is selected, food with a high moisture content is sealed before storage, any food in the compartment is loosely packed and the door is not opened unnecessarily.

*Liquid refrigerant in the refrigerator will make a sound similar to that of flowing water.

*In winters, it is necessary to keep the refrigeration temperature to 0°C not above 0°C and below 10°C.

Questions and Answers

Please determine the cause of the problem before making any repairs.

Operation failure of the refrigerator	<ul style="list-style-type: none">*Disconnection of power supply (plug, socket and fuse);*Voltage is low.
Failure of lamp	<ul style="list-style-type: none">*The bulb is bad;*Power supply is connected.
Excessive noise.	<ul style="list-style-type: none">*Contact between the refrigerator and a wall or other article;*Uneven placement.
Failure of set temperature	<ul style="list-style-type: none">*The thermostat is not properly set.*The door is not properly closed; or the door is opened for long period.*The refrigerator is in direct sunlight, or close to a heat source;*The area is poorly ventilated, or the two sides of the refrigerator are blocked or badly contaminated.
Strange odor	<ul style="list-style-type: none">*Failure to seal food properly;*Rotting food inside refrigerator;*Failure of regular cleaning of the refrigerator.
Long operation period of the compressor	<ul style="list-style-type: none">*Initial operation*Large quantity of food loaded*Hot weather*Frequent opening of the refrigerator door*Not properly closed door*Improper setting of the thermostat (see the section of "Operation")
Thick frost formation on back wall in refrigerator compartment	<ul style="list-style-type: none">*Thermostat not properly set (see section "Operation")*Door is not closed.*Frequent opening of the refrigerator door*Hot weather*Excessive moisture
Water drops form on middle front and door decal	<ul style="list-style-type: none">*High ambient temperature or heavy moisture. Wipe clean with a soft cloth.*Thermostat is set too high.
Accumulated of spilt water in the refrigerator compartment	<ul style="list-style-type: none">*Water outlet is blocked. Clean the outlet with the cleaning rod.



The symbol  on the product or on its packaging indicates that this product may not be treated as household waste. Instead it shall be handed over to the applicable collection point for the recycling of electrical and electronic equipment. By ensuring this product is disposed of correctly, you will help prevent potential negative consequences for the environment and human health, which could otherwise be caused by inappropriate waste handling of this product. For more detailed information about recycling of this product, please contact your local city office, your household waste disposal service or the shop where you purchased the product.

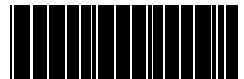

00607111520Q