



CM105

Caple Microwave Oven & Grill



TECHNICAL INFORMATION



CM105

Caple Microwave Oven & Grill

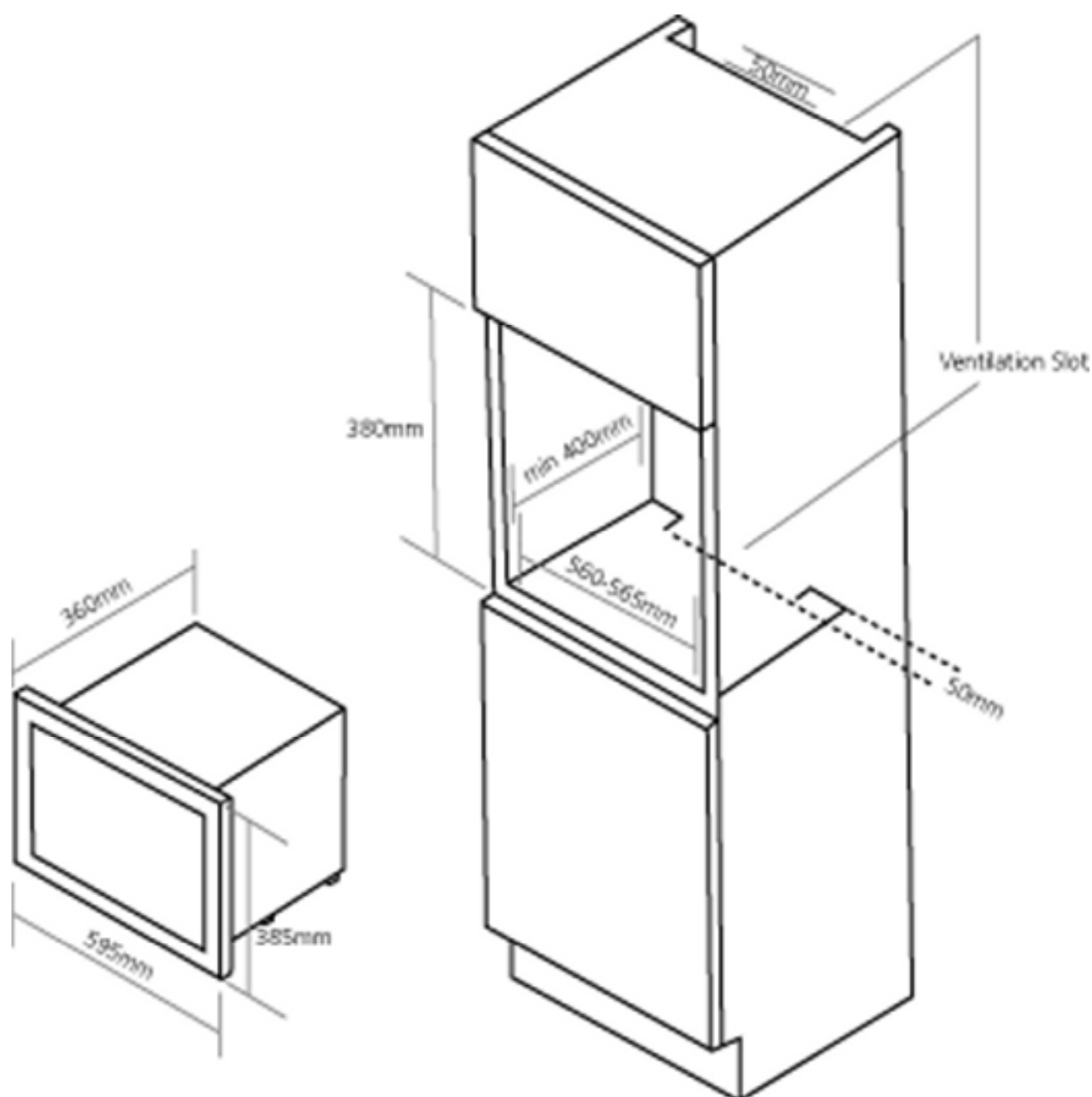

Building-in Kit for Capele Combination Microwave

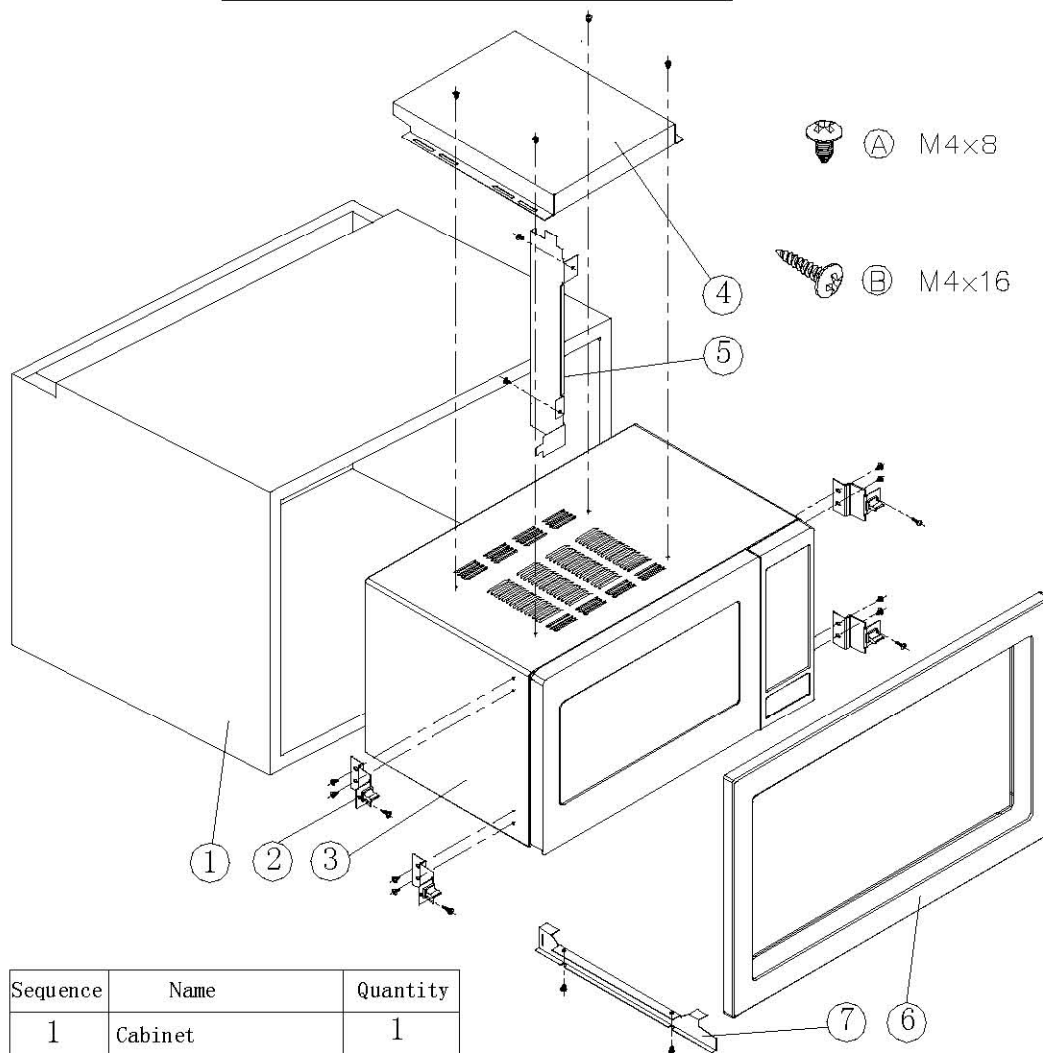

Sequence	Name	Quantity
1	Cabinet	1
2	Front Frame Clip	4
3	Microwave Oven	1
4	Upper Exhaust Duct	1
5	REAR SPACER for rear of microwave	1
6	Front Frame	1
7	BOTTOM SPACER for under microwave	1

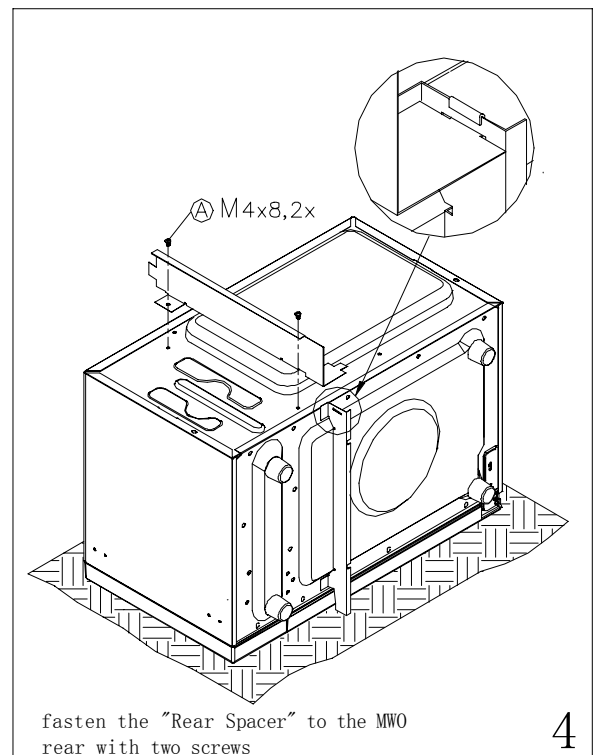
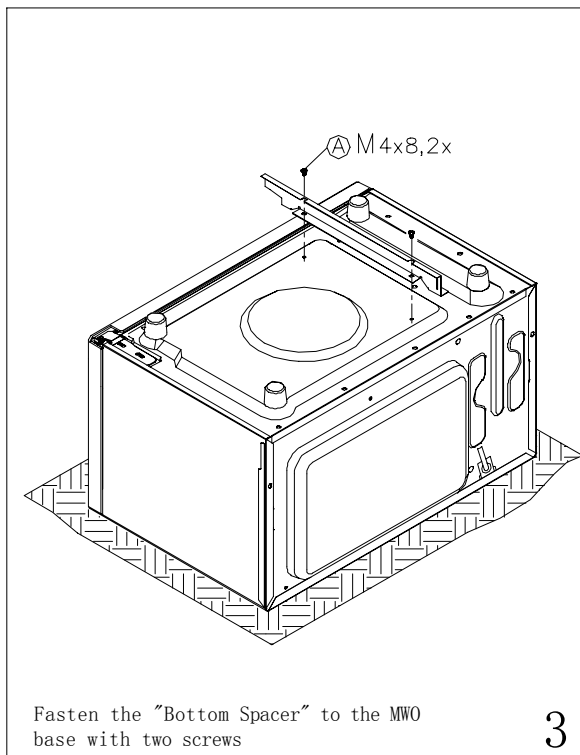
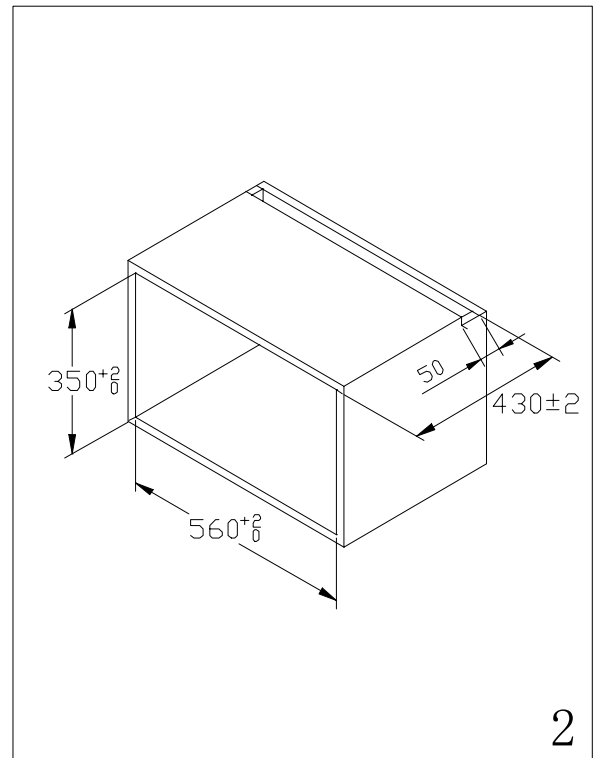
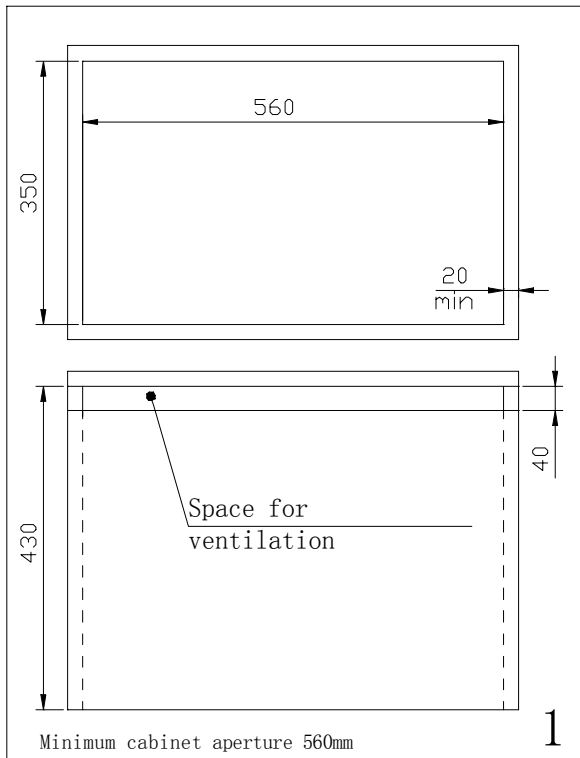

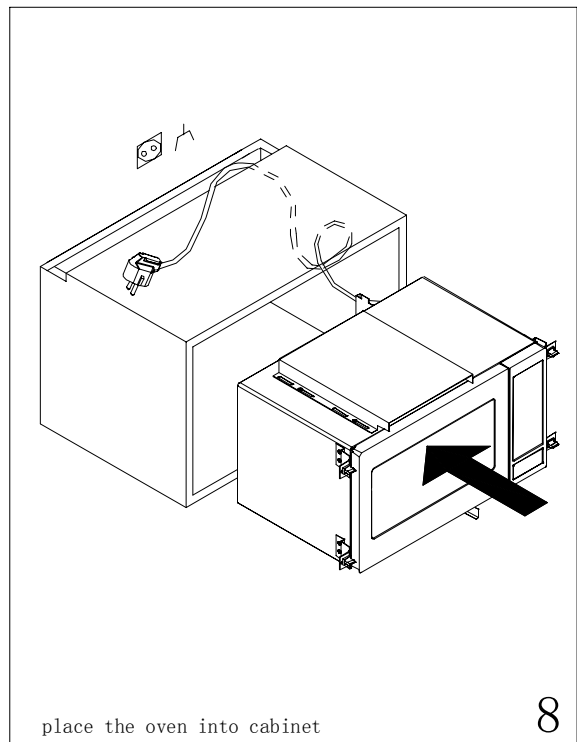
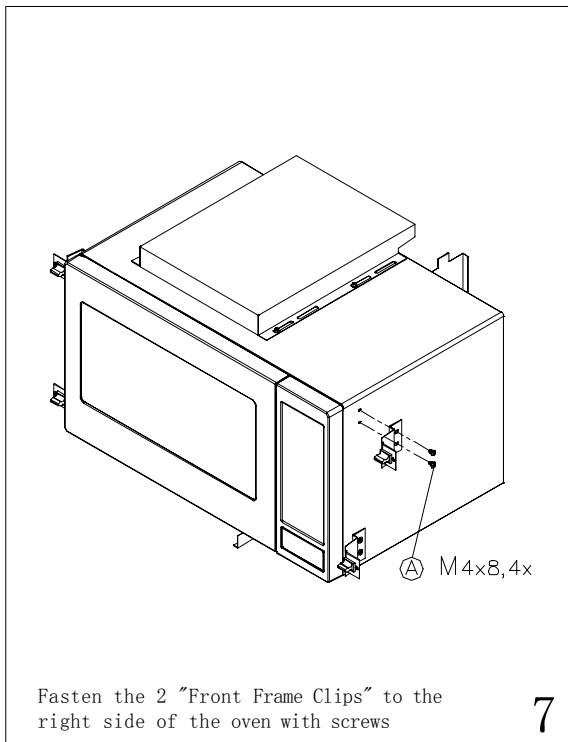
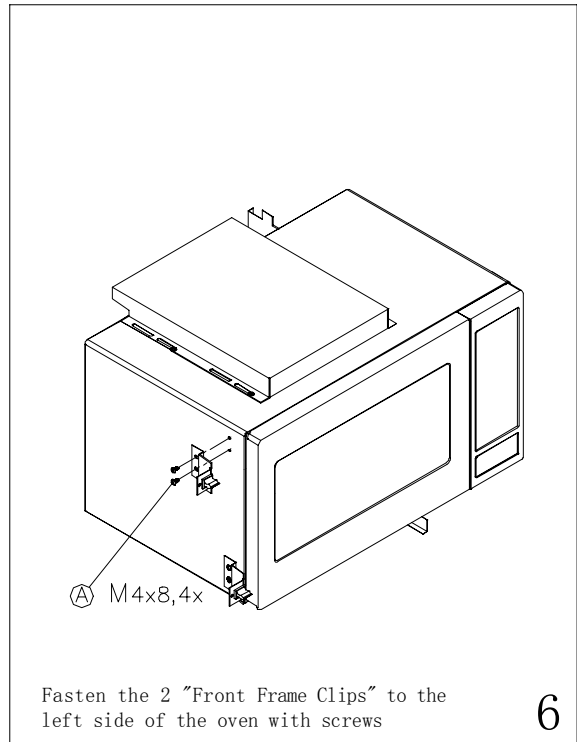
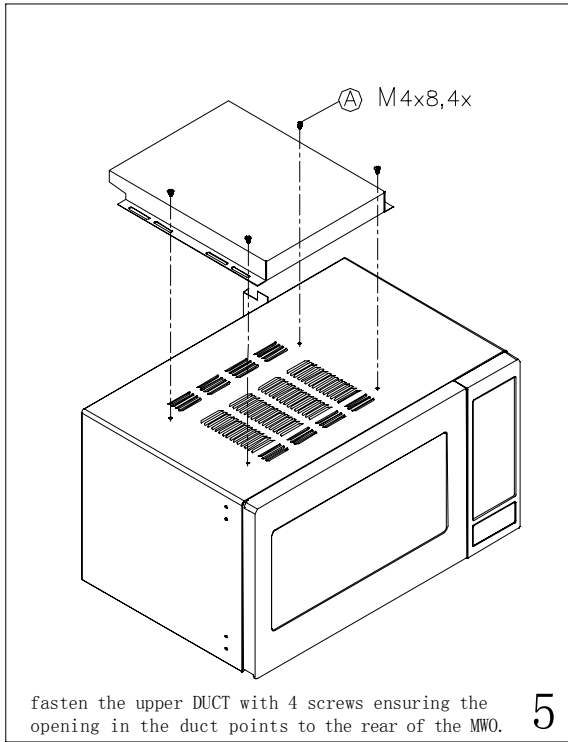

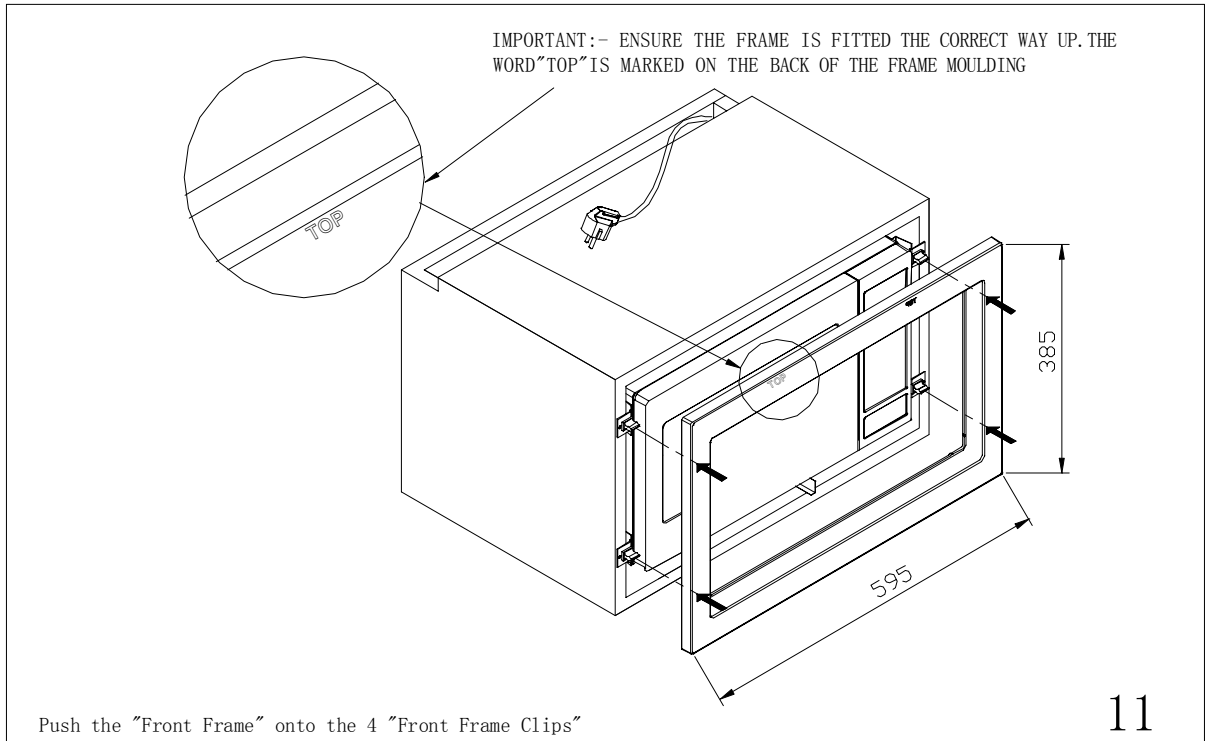
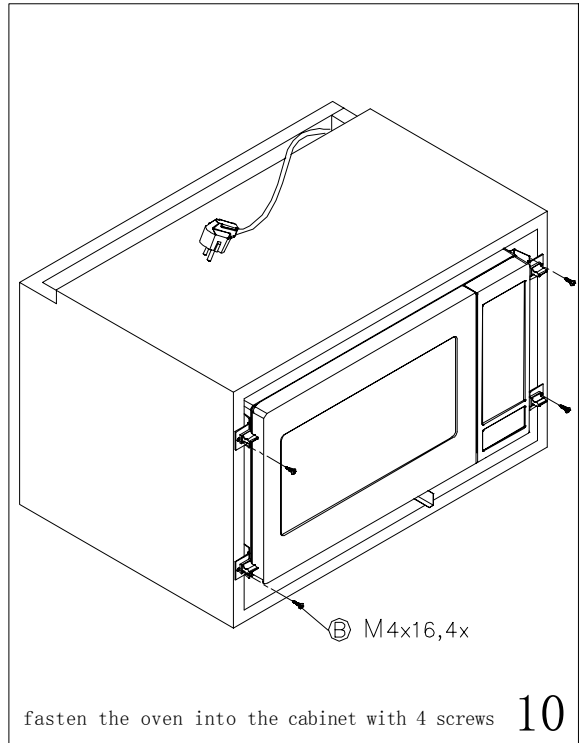
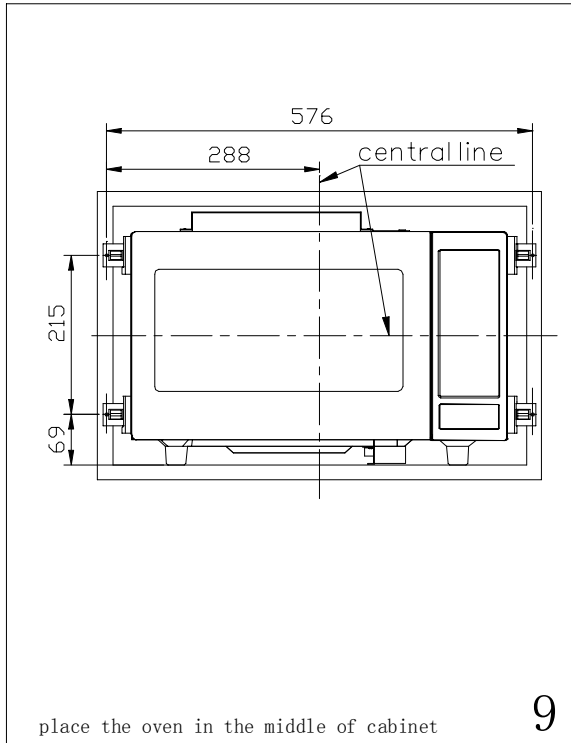

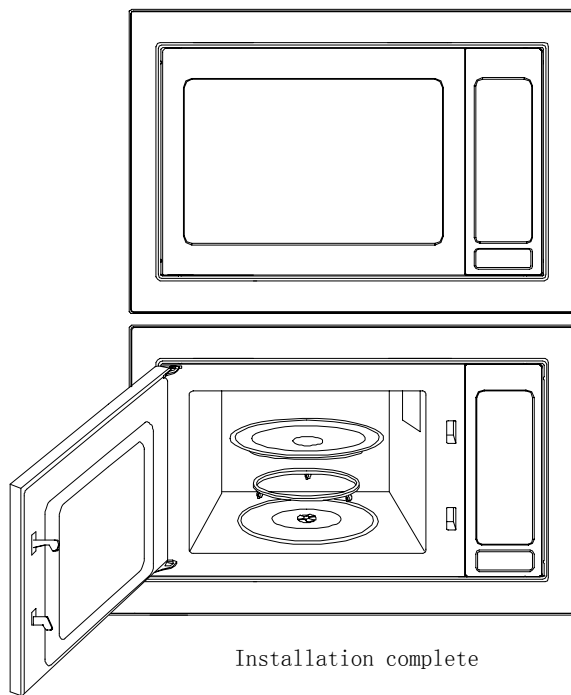

Installation complete

12

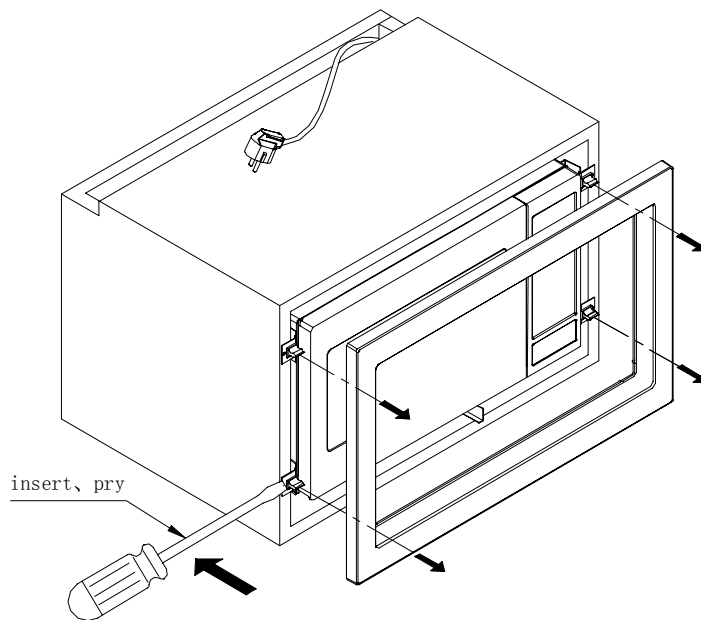

insert, pry

TO REMOVE FRAME

Insert flat bladed screwdriver and pry the front frame from the fixing clips.

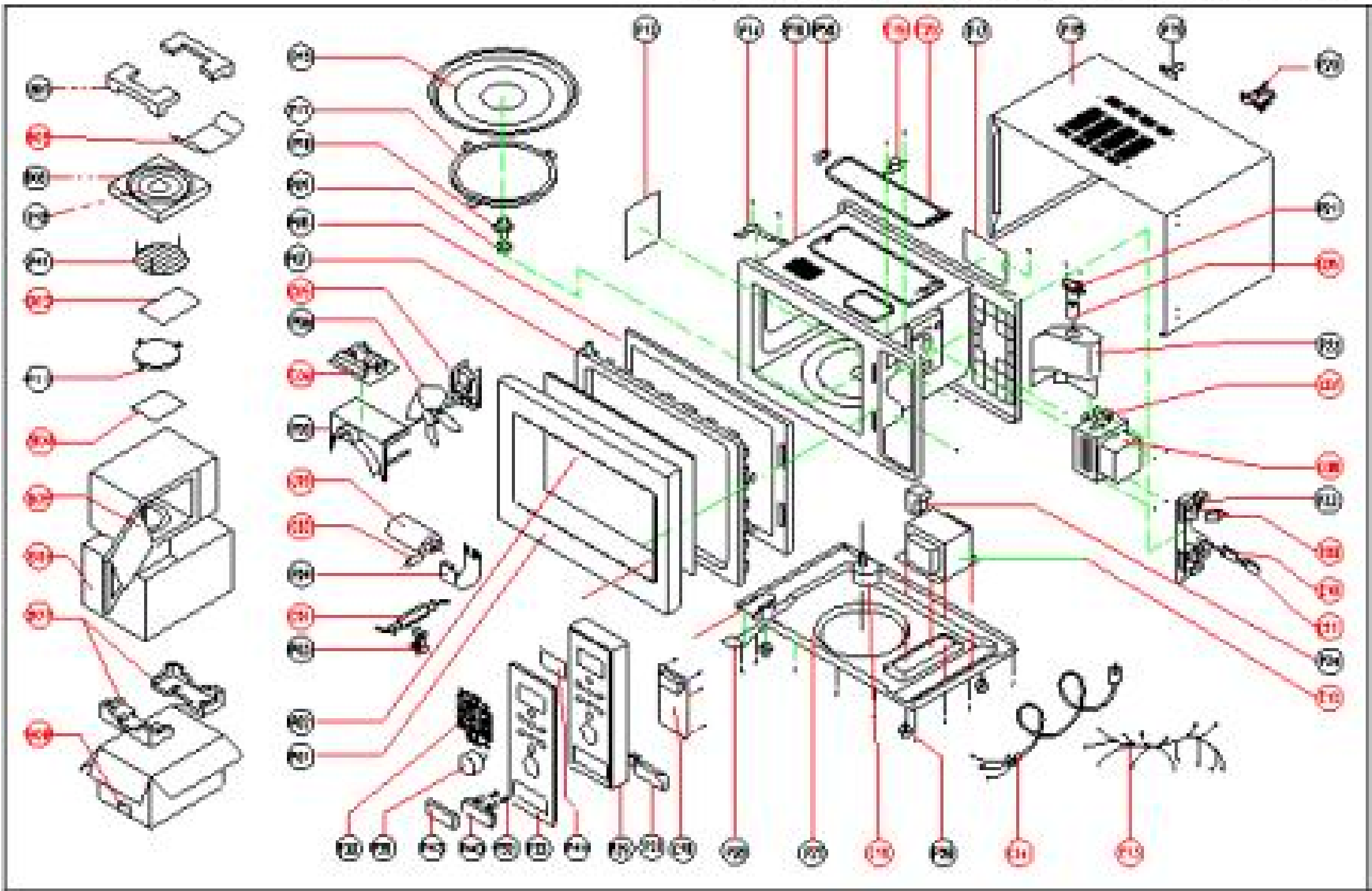

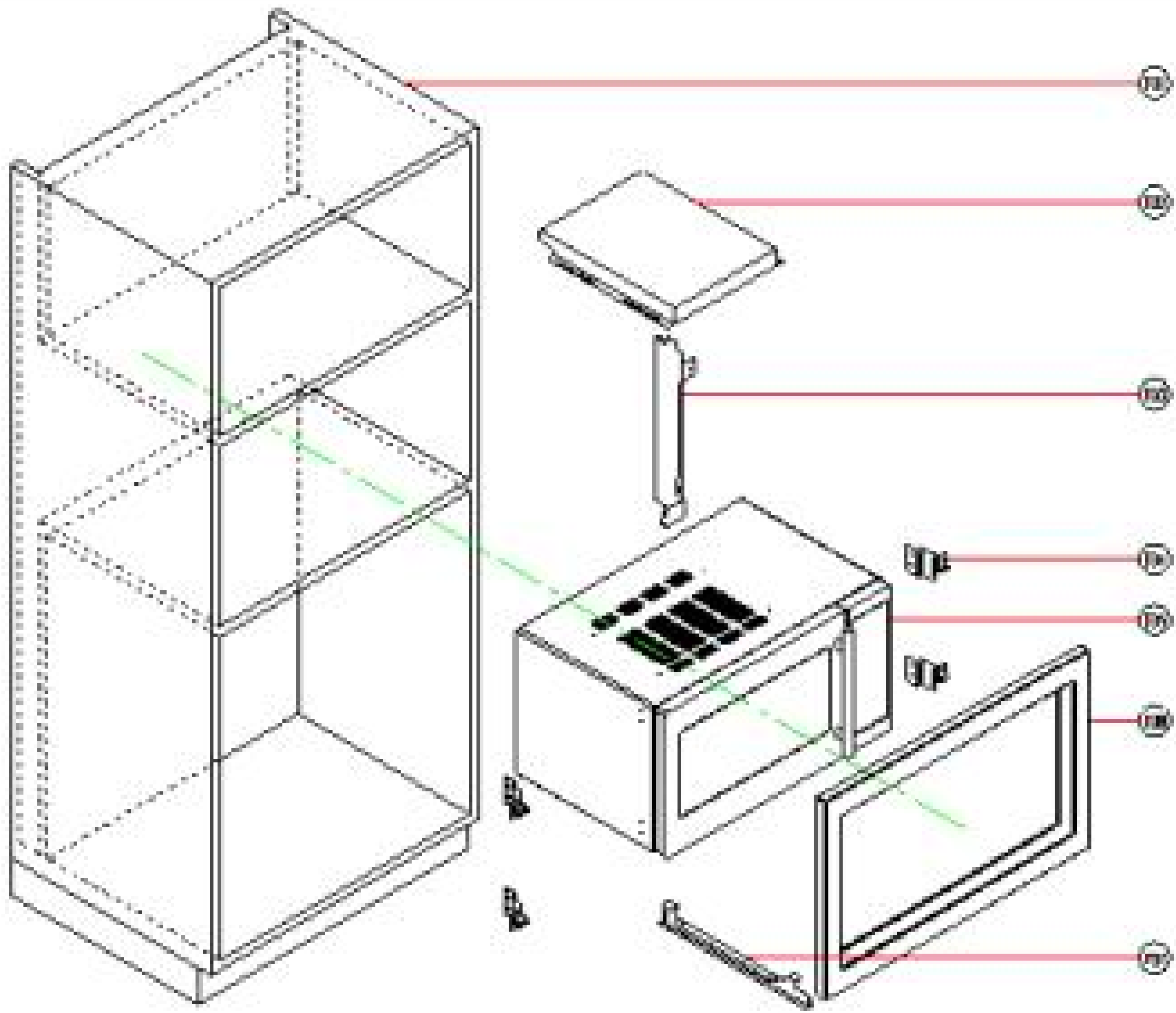



CM104 - Caple Microwave Oven & Grill

Parts and Components List

Art.	Name	Count	Art.	Name	Count
P01	door (with inlaids)	1	C01	h.v. fuse	1
P02	door window	1	C02	h.v. diode	1
P03	fuse socket	1	C03	h.v. capacitor	1
P04	capacitor holder	1	C04	wave filter	1
P05	fan shroud	1	C05	fan motor	1
P06	fan blade	1	C06	lamp	1
P07	door frame	1	C07	thermostat	1
P08	choke cover	1	C08	magnetron	1
P09	washer	1	C09	microswitch	1
P10	shaft	1	C10	microswitch	1
P11	roller ring	1	C11	microswitch	1
P12	glass tray	1	C12	transformer	1
P13	splash shield	1	C13	wiring harness	1
P14	upper hinge	1	C14	power cord	1
P16	cavity	1	C15	turntable motor	1
P17	label	1	C16	p.c. board	1
P18	outer enclosure	1	C19	thermostat	1
P19	heater holder	1	C20	heater	1
P20	power cord holder	1			
P21	lamp socket	1			
P22	air duct	1			
P23	microswitch mounting	1	F01	cabinet	1
P24	shockproof rubber	1	F02	upper exhaust guide	1
P25	transformer bracket	4	F03	back cover board	1
P26	foot	1	F04	shutter holder	4
P27	base plate	1	F05	microwave oven	1
P28	lower hinge	1	F06	shutter	1
P29	control panel	1	F07	down cover board	1
P31	lever	1			
P32	button spring	1	B01	upper foam cushion	1
P33	metal shell	1	B02	turntable cushion	2
P38	key pads	1	B03	plastic bag	1
P39	knob	1	B04	manual	1
P40	button	1	B05	protection film	1
P41	baking plate	1	B06	plastic bag	1
P43	button shell	1	B07	lower cushion	2
P44	display	1	B08	carton	1
P58	ceramic holder	1	B09	cardboard	1