



SO108

Caple Steam Oven 450mm



INSTRUCTION MANUAL

List of contents

Introduction	p.3
Steam cooking	
Steam cooking	p.4
Safety instructions	p.5
Care for the environment	p.6
Your oven, how it works	p.7
Accessories	p.8
How to install your oven	
Electrical connection	p.9
Fitting	p.10
How to use your oven	
Setting the time	p.11-12
Cooking immediately	p.13-14
Managing the water	p.14
Delayed cooking	p.16
The timer	p.17
Cooking times	p.18-19
How to maintain your oven	p.20
Changing the light bulb?	p.21
Troubleshooting ?	p.21

Dear Customer,

You have just acquired a CAPLE oven and we would like to thank you.

We have invested all our dedication and know-how in this appliance so that it would best meet your needs. With innovation and performance, we designed it to be always easy to use.

In the CAPLE product range, you will also find a wide choice microwaves, cooking hobs, ventilation hoods, cookers, that you can coordinate with your new CAPLE oven.

CAPLE

As part of our commitment to constantly improving our products, we reserve the right to make changes to them based on technical advances to their technical and functional features and appearance.



Warning: Before installing and using your appliance, please carefully read this Guide to Installation and Use, which will allow you to quickly familiarise yourself with its operation.

Steam cooking

Overview

Steam cooking presents nothing but advantages if you follow the instructions for use. Healthy and natural, steam cooking preserves the full flavour of foods. A delicate sauce or aromatic herb seasonings add that something extra that makes the difference.

This kind of cooking releases no odours. There is no need to season the cooking water with herbs or spices; however, you can flavour a fish by placing it on a bed of seaweed or make a savoury poultry dish by adding a bunch of rosemary or tarragon.

You can simultaneously cook meat, fish and vegetables.

Steam cooking gently reheats pasta, rice and mashed potatoes with no risk of food sticking or drying out.

It facilitates cooking custard creams and tarts, rice pudding... covered with aluminium foil, the condensation water does not add moisture to the preparations.

There is no need to season before cooking, not even the steam water.

To make meat look more appetising, quickly brown it on all sides with hot butter in a pan.

Compared to boiling, steam offers nothing but advantages:

It is quick: cooking starts immediately whereas for food in a water-filled dish, the cook time only begins counting down once the water returns to a full boil.

It is healthy: vitamins (those that are water soluble) and minerals are well preserved because they scarcely dissolve in the condensation water that touches the food.

Moreover, no fats are used for this type of cooking.

The steam maintains the taste of food. It does not add odours, nor the taste of the grill or the pan. Furthermore, it takes nothing away because the food is not diluted in the water.

Words of advice: there is no point in using this cooking method to prepare fish that is not fresh or vegetables left in the refrigerator for a week: the results will be catastrophic!

therefore do not hesitate to save both time and money by cooking items side by side, but without touching. For example, you can cook a fish next to a dessert.

Steam is also appropriate for blanching, defrosting and reheating or even holding warm, especially sauces.

First use a very small amount of fat to heat meats like poultry, veal and pork so that they take on an appetizing browned appearance. Then finish cooking them using the steam method.

Cut into pieces, food cooks faster and more evenly than if left whole.

Safety instruction



Warning

Keep this user guide with your appliance. If the appliance is ever sold or transferred to another person, ensure that the new owner receives the user guide. Please become familiar with these recommendations before installing and using your oven. They were written for your safety and the safety of others.

Safety instructions

— This oven was designed for use by private persons in their homes. It is intended solely for cooking foodstuffs. This oven does not contain any asbestos-based components.

— This appliance is not intended for use by people with (including children) impaired physical, sensorial or mental abilities, or people lacking in knowledge or experience, unless they receive prior supervision or instructions on using the appliances through a person responsible for their safety.

— When you receive the appliance, unpack it or have it unpacked immediately. Give it an overall inspection. Make note of any concerns or reservations on the delivery slip and make sure to keep a copy of this form.

— Your appliance is intended for standard household use. Do not use it for commercial or industrial purposes or for any other purpose than that for which it was designed.

— Do not modify or attempt to modify any of the characteristics of this appliance. This would be dangerous to your safety.

— Warning: Accessible parts may become hot during use. Young children should be kept away

— Never pull your appliance by the door handle.

— During cooking, ensure that the door of your oven is completely closed so that the seal can do its job properly.

— Please make sure children do not play with the appliance.

— When in use, the appliance becomes hot. Do not touch the heating elements located inside the oven. In doing so, you would run the risk of suffering serious burns.

— When placing dishes inside or removing them from the oven, use heat-protective kitchen gloves.

— At the end of cooking, do not touch the dishes with bare hands.

— Do not place heavy weights on the open oven door, and make sure that children are able neither to climb nor sit on it.

— The oven must be turned off when cleaning inside the oven.

— Intensive and prolonged use of the appliance may give rise to the need for additional ventilation, by opening a window, or by increasing the power of the mechanical fan.

— Additionally to the accessories supplied with your oven, only use dishes which resist high temperatures (follow the manufacturer's instructions).

— After using your oven, make sure that all the controls are in their stop position.

— Never use steam or high-pressure devices to clean the oven (requirement imposed by electrical safety concerns).

— Children should be supervised to ensure they do not play with the appliance.

Steam cooking

Care for the environment

— This appliance's packing materials are recyclable. Recycle them and play a role in protecting the environment by depositing them in municipal containers provided for this purpose.



— Your appliance also contains many recyclable materials. It is therefore marked with this logo to indicate that used appliances must not be mixed with other waste. Recycling of the appliances organised by your manufacturer will thus be undertaken in optimum conditions, in accordance with European directive EC/2002/96 relating to electrical and electronic equipment waste. Consult your city hall or your retailer to find the drop-off points for used appliances that is nearest to your home.

— We thank you for your help in protecting the environment.



Warning

Installation should only be performed by installers and qualified technicians.

This appliance complies with the following European directives:

- Low Voltage Directive EEC/73/23 modified by directive EEC/93/68 for insertion of EC marking.

- Electromagnetic Compatibility Directive 89/336/EEC modified by directive 93/68/EEC for insertion of EC marking.

- EC regulation no. 1935/2004 concerning materials and objects intended for contact with food substances.

Your oven, how it works

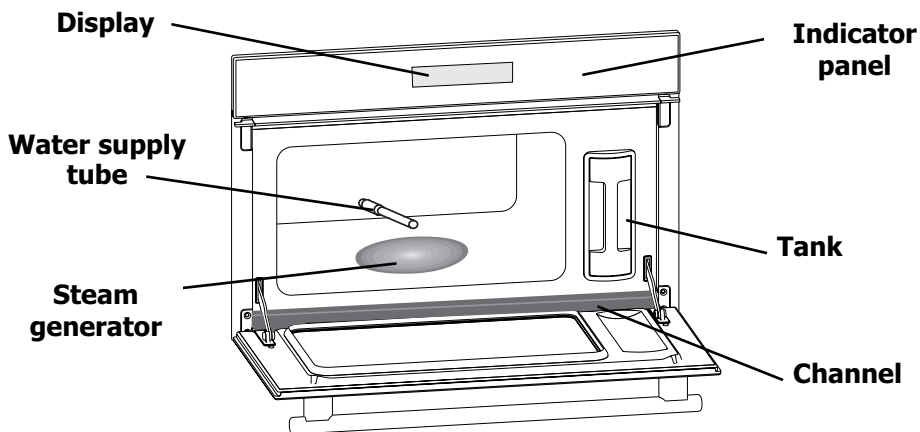

The indicator panel in detail

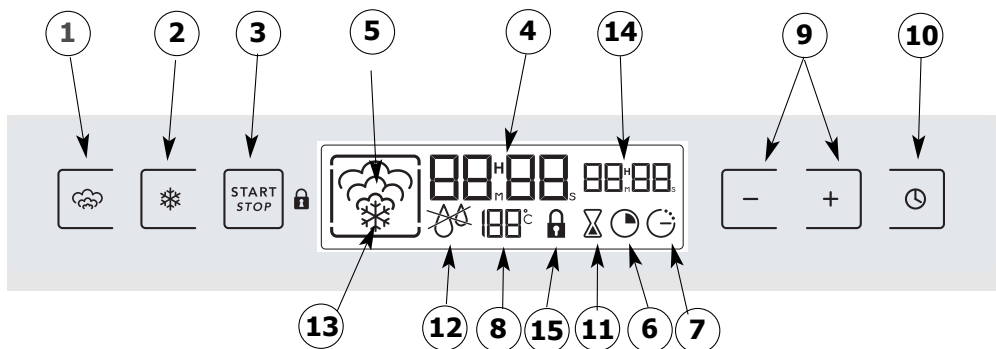

- | | |
|--|---|
| <ol style="list-style-type: none">1. Steam cooking control2. Defrosting button3. Start/Stop control4. Time and delay display or timed period5. Steam cooking symbol6. Cooking time symbol7. End of cooking time symbol | <ol style="list-style-type: none">8. Temperature display9. +/- controls for timer10. Selector button : SET11. Autonomous timer12. Water circuit problem signal13. Defrosting symbol14. Display of the cooking period or delayed start time15. Control panel locked |
|--|---|

Accessories

Tin ware

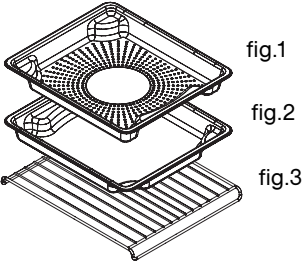

Food dish (fig.1)

Pierced stainless steel cooking dish to prevent contact between food and condensation water.

Condensate dish (fig.2)

Dish to recover the condensation water.



When cooking place the fig.1 dish on the fig.2 dish in reverse order so that they do not fit into each other (see diagram).

When storing place the fig.1 dish on the fig.2 dish in the same order so that they fit into each other.

Grid (fig.3)

Stainless steel removable support grid: it must be placed in the oven.

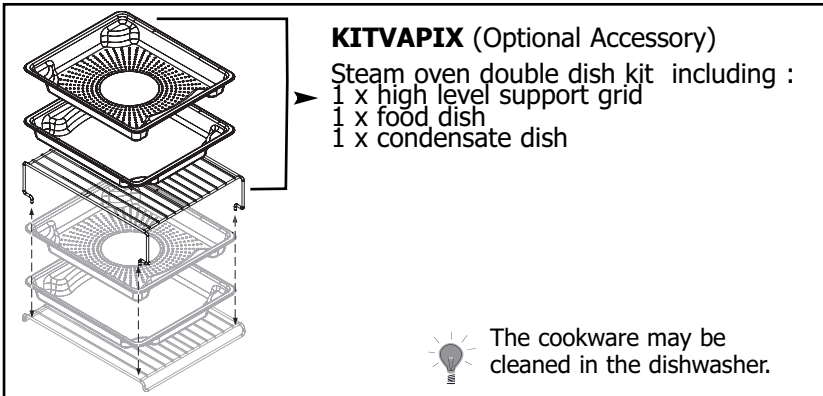

KITVAPIX (Optional Accessory)

Steam oven double dish kit including :
1 x high level support grid
1 x food dish
1 x condensate dish



The cookware may be cleaned in the dishwasher.

Removable tank

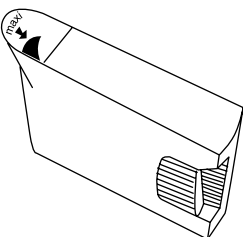

Tank for the independent water supply of your oven. It can hold about 1 litre (maximum level).



Use of water that is low in calcium will make cleaning your oven easier.



The use of distilled water is forbidden (not suitable for food use).

How to install your oven

Electrical connection

For a permanent connection, make sure a system of disconnection that complies with the installation regulations. The appliance must be placed in such a way as to leave the plug accessible if it is flush-fitted.

Use of an earthed power socket, connected in compliance with current safety standards

Your installation must be fitted with a 10 amp device for thermal protection.

Do not use the oven if the supply cord or its plug are damaged. In this case, they must be replaced by the manufacturer, its after-sales service or similarly qualified persons, to avoid any danger.

It is necessary to allow the disconnection of the appliance from the supply after installation either with the plug which should remain accessible, or by incorporating a switch in the fixed wiring in accordance with the wiring rules.

How to install your oven

Fitting

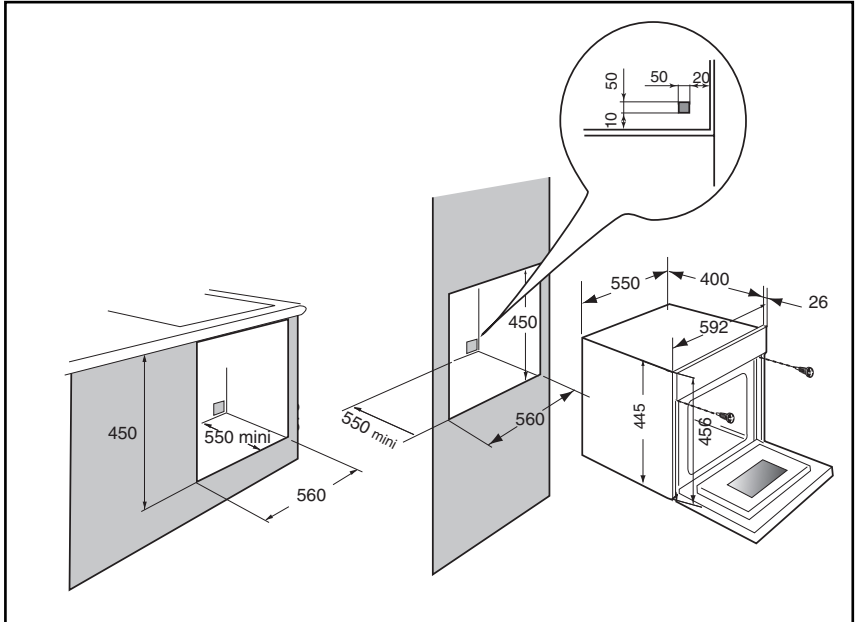

1. Place the appliance in the hole.
The appliance must be horizontal. Check this position.
2. For improved stability, attach the oven to the unit using 2 screws, via the holes provided for this purpose on the side posts.
3. Carry out the electrical connection.



Make sure that the rating plate remains accessible after installation.

How to use your oven

Setting the time

The first time the oven is turned on:
Set the time.

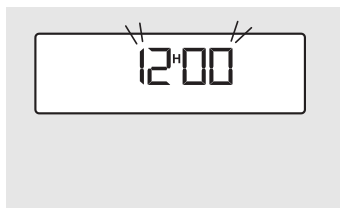

1 The display flashes on 12.00.

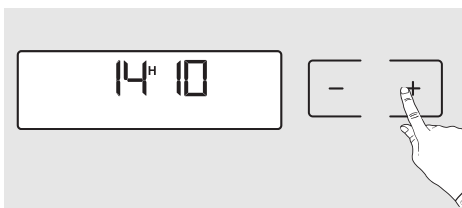

2 Use the + and - buttons to adjust the time.

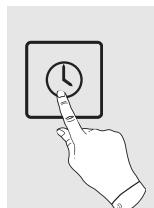

3 Validate with SET.

Changing the time

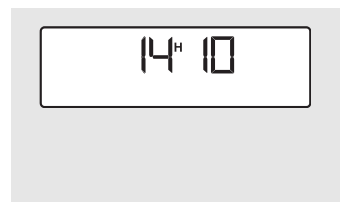

1 The time is displayed.

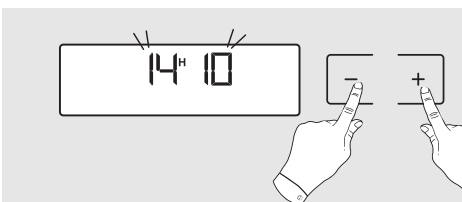

2 Press on the + and - buttons simultaneously until the time starts to flash. Adjust the time using the + and -button.

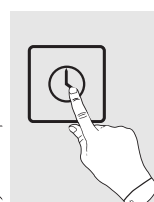

3 Validate with SET



If the time set is not validated by the SET button, it is automatically recorded after one minute.

Reducing energy consumption

After one minute of inactivity, display brightness is reduced, in order to reduce energy.

Locking the control panel

The control panel can be locked. This can only be activated when you are not using timed or delayed cooking features.

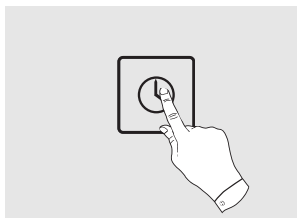

1 Hold down the START/STOP button for a few seconds.

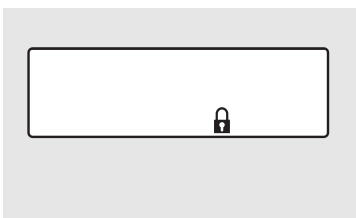

2 A beep sounds and a "padlock" appears on the screen. From this moment, no button is live.

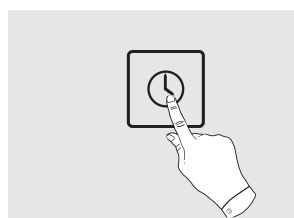

3 To unlock, hold down the START/STOP button for a few seconds. A beep sounds and the padlock disappears.

Cooking immediately

Operational principle

The water contained in the tank reaches the cavity via a tube. This water is transformed into steam on contact with a hot surface placed in the lower part of the cavity: the steam generator.

There is no need to add water to the cooking dish. To guarantee TRUE STEAM COOKING, your oven is supplied with a set of specially designed for cookware to perfection.

- ⚠ You MUST IMPERATIVELY fill the water tank up to the **maximum** level before starting cooking. Put the tank back in place, and push it as far as possible until it **CLICKS INTO PLACE**.
- ⚠ When cooking, the appliance gets hot. Hot steam may escape when you open the door of the appliance. Keep children out of the way.

Steam cooking

Steam cooking at 100°C.

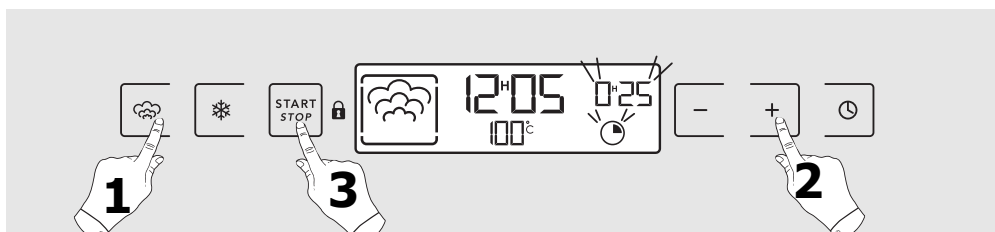

- 1** Press the button . A time of 25 minutes is suggested.
- 2** Adjust the cooking time as necessary (minimum 5 min and maximum 60 min by pressing on + and - buttons)
- 3** Validate with the START STOP button.

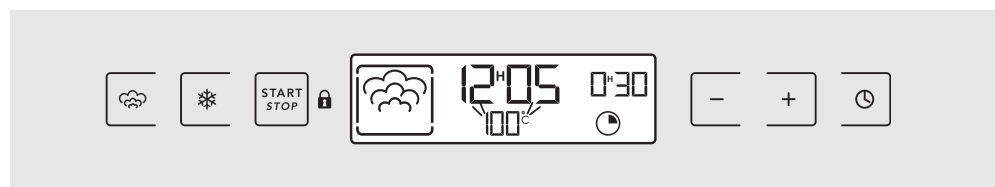

- 4** The symbol comes on. When the temperature is reached, 100° becomes constant, and a beep sounds.

In order to avoid altering the results of the cooking, avoid opening the appliance door during cooking.

Defrosting

Defrosting at 60°C.

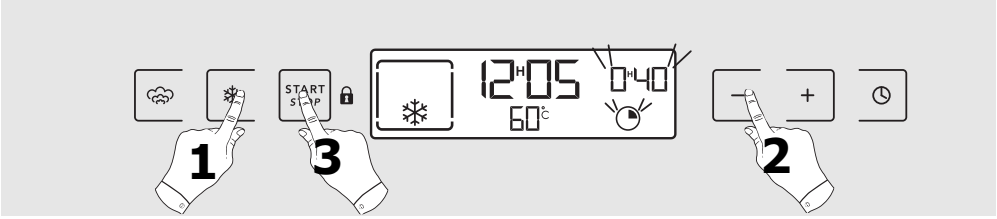

- 1** Press the button ❄️ .
A time of 40 minutes is suggested.
- 2** Adjust the cooking time as necessary (minimum 5 min and maximum 60 min by pressing on + and - button.
- 3** Validate with the START button.

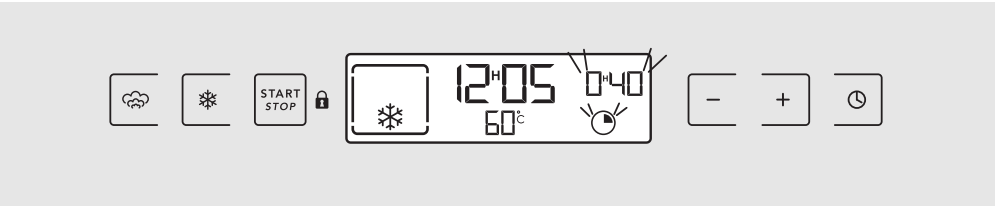

- 4** The symbol ❄️ comes on. When the temperature is reached, 60° becomes constant, and a beep sounds.

Modifying the cooking time

During cooking, you can modify the cooking time by using the + and - buttons.

Stopping the appliance during cooking

You can stop the cooking at all times by pressing on START/STOP (hold the button down for about 1 second).

If the steam production has not yet started (about 1 minute), the oven will stop immediately and the time setting will disappear.

If the steam production has already started, the time passes to 3 minutes and during this period, the steam evacuates before you open the oven.

At the end of cooking

0m00s displays. The display animation stops. Beeps are heard for a 3 minute period.
To stop the beeps, press on STOP and open the door.

⚠️ You MUST IMPERATIVELY empty the tank



In order to make sure the oven is reliable, the fan continues to operate for a certain period after the end of cooking.

Advice

Freeze small portions; defrosting will be faster, more homogenous and quality will be preserved. When semi-defrosted, you can turn over the food items or spread them out (for example vegetables patties). Protect pastries with a cling wrap or keep the original packaging. Wipe fish and sausages before grilling: humidity stops them from becoming golden brown. For large pieces (roasts, etc.) proceed in steps by turning the piece over several times and adjust the time accordingly.

VEGETABLES	Patties (spinach, etc.)	placed on dish	25 min
	In blocks	placed on dish	40/45 min
	Trout (whole)	placed on dish	30 min
FISH	Salmon steak	placed on dish, turned over half way through	25 min
	Filets (protected by a cling wrap)	placed on dish	15/20 min depending on thickness
	Prawns	placed on dish	10/12 min
MEATS	Chicken thighs	placed on dish, turned over half way through	40/45 min
	Poultry breast (protected by a film)		25 min
	Sausages	placed on dish	25 min
	Chops (pork, veal, etc.)	placed on dish, protected by a cling wrap, placed on the grill	25/30 min
	Liver cubes (for skewers)	to be separated half way through	55/60 min
FRUIT	Mixed berries	placed on dish	15 min
	Stewed fruit (apple, etc.)	protected by a cling wrap	35/40 min
PASTRIES	Doughnuts	kept in packaging, placed on the grill	15 min
	Chocolate croissants	kept in packaging, placed on the grill	15 min

Reheating

You can reheat a cooked dish in your steam oven. The dish will not dry out, will not become overcooked and will not splatter or stick. Adjust steam sequence at 100°C, place the dish or plate on the grill, protect with aluminium foil or cling wrap to avoid drops of water accumulating and heat for 20 to 25 minutes depending on the dish and your preferences.

Examples:

A plate of sauerkraut: 20 min

A bowl of soup (300 ml): 20/25 min

Managing the water

In case of problems related to the water circuit during cooking, the 'no water' symbol appears and a beep sounds. This fault is specifically related to:

- an empty tank,
- a wrongly-fitted tank.

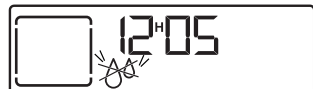

After checking these two points, the cooking will recommence automatically after the door.

Delayed cooking

Steam cooking

Steam cooking at 100°C.

You can program the cooking time so that your dish is ready at a time of your choice.

For example:

It is 10 o'clock, and you have to go out, your dish should be ready at 12 o'clock and it will take 20 minutes to cook.

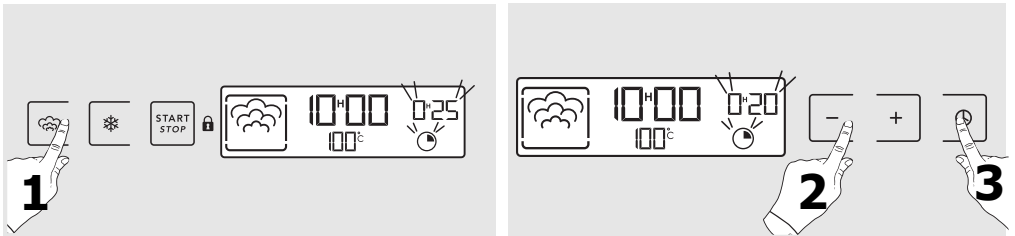

1 Press the button . A time of 25 minutes is suggested.

2 Adjust the cooking time as necessary (minimum 5 min and maximum 60min) by pressing on + and - button.

3 Validate with the SET button.

For example : 20 min.

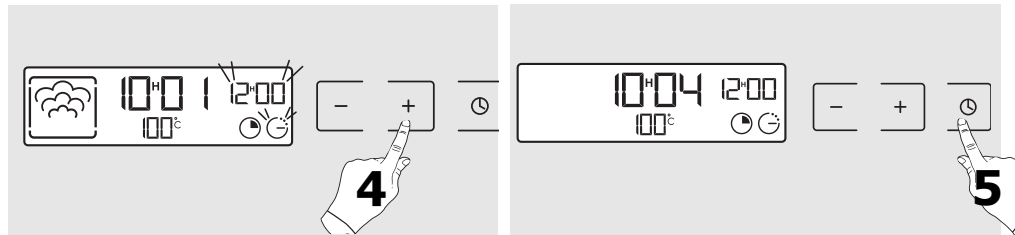

4 The time and the end of cooking time symbol display and flash. The adjustment of the end of cooking time is now possible:
Press the + or - buttons
For example : 12h00

5 Validate with the SET button.
The time and the end of cooking time become constant.
The symbol for the length of cooking time displays.

If the programming is not validated by touching SET, the recording of the program is cancelled, the time display disappears and the time is displayed again.

Modification of cooking time and the end of cooking time

You can consult or modify the length of cooking time and the end of cooking time, at all times.

To cancel the programming, press START/STOP.

How to use the timer

Timer

Your oven is fitted with an electronic timer that is independent of the operation of the oven, and allows time to be counted down.

 This function is independent of your oven. It can not order the end of automatic cooking.

However, this function can be used even during operation of the oven. In this case, the display of the timer is given priority over the display of the time.

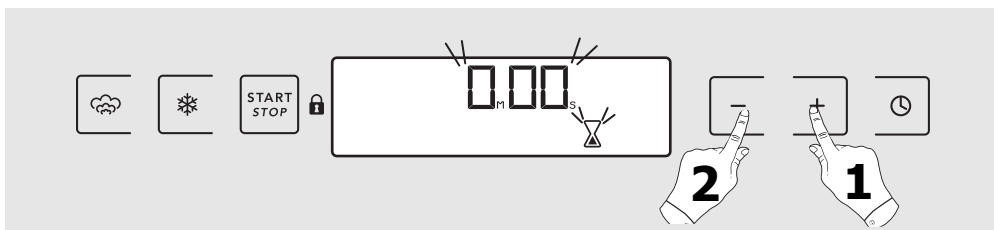

1 Hold the SET button down for a few seconds. 00m00s and the timer symbol flash.

2 Adjust to the period required (maximum 9 minutes and 50 seconds) using the + and - buttons. After a few seconds, the timer counts down the time.

Once the time has run out, beeps will sound every few seconds. 0m00s displays and flashes.

The beeps can be stopped by holding down SET or START.

Modifying and stopping the timer

Once the countdown has started, you can modify the time remaining by holding down SET then pressing the + or - buttons.

To cancel the timer, hold SET down for a few seconds, then return the time to 0m00s.

Cooking times

VEGETABLES	TIME <small>Whatever the quantity</small>	PREPARATION	REMARKS
Artichokes (Small)	40 to 45 min .	placed upside down in the dish	<ul style="list-style-type: none"> • These times depend on the nature, size and freshness of the vegetables. Follow the instructions given in the "Preparation" column. • The cooking time is the same regardless of the quantity to be cooked. <i>For example :</i> 1 or 4 artichokes, same cooking time. • To check how well done the food is, test the thickest part of the vegetable; if it is cooked, it will not resist.
Asparagus	35 to 40 min.	for the tips, reduce the cooking time	
Broccoli	18 min.	in little flowerets	
Carrots	20 to 22 min.	in fine slices	
Celeriac	25 to 30 min.	in fine slices	
Pumpkin	15 to 20 min.	in cubes	
Mushrooms	15 min.	in fine strips	
Cabbage	30 to 35 min.	Brussels sprouts	
	22 min.	Flowers in little bunches	
	30 to 35 min.	Green shredded	
Courgettes	10 to 15 min.	in slices	
Chinese artichokes	20 min.	(fresh) stir during cooking	
Spinach	20 min.	(frozen) " " "	
	35 min	core removed and cut in two	
Chicory	30 min.	lengthwise	
Fennel	22 min.	cut in 2	
Green beans	30 to 35 min.		
Turnips	15 to 20 min.	cubed	
Fresh peas	20 to 25 min.	/	
Leeks	25 min.	cut in 2	
Potatoes	25 min.	sliced	
	40 to 45 min.	whole	
SHELLFISH	TIME	PREPARATION	REMARKS
Scallops	10 to 12 min.	with aromatic herbs	<ul style="list-style-type: none"> • Arrange the shellfish on a grill or glass dish, and add a few aromatic herbs • Arrange seafood on a bed of seaweed.
Mussels/Whelks	20 to 25 min.	with aromatic herbs	
Crabs/Lobster/	25 min.	/	
Dublin Bay	30 to 35 min.	according to weight	
Prawns	12 to 15 min.	/	
FRUITS CUSTARDS	TIME	PREPARATION	REMARKS
Apples/ pears/ peaches	10 to 15 min.	whole, peeled	Time according to ripeness
puree	25 min.	strips of fruit	
Custards	10 min.	in ramekins	

FISH	TIME	PREPARATION	REMARKS
Pike	25 to 30 min.	whole (1kg)	<ul style="list-style-type: none"> *Steaks :slices of fish 2 or 3 cm thick (180/200g) per person. • Always insist on very fresh products • Place whole fish directly into the dish or on bay leaves, fennel or other herbs. • At the end of cooking, remove the skin which will come away easily.
Cod/hake	13 to 15 min.	steaks (180g)*	
Sea bream	20 to 25 min.	whole (1kg)	
Haddock	15 min.	fillets	
Herring	20 min.	whole (200g)	
Monkfish	15 to 20 min.	steaks (180 g)	
Lotte	15 min.	according to thickness	
Mackerel	20 min.	whole (250g)	
Whiting/cod	15 min.	fillets	
Skate	25 to 30 min.		
Mullet	15 min.	whole (200g)	
Mullets	10 min.	fillets	
Dogfish	20 min.	thick slice (6 to 10 cm long)	
Salmon	15 to 20 min.	steaks (180/200 g)	
Sole	10 to 12 min.	fillets	
Tuna	20 to 25 min.	steaks (180/200 g)	
Whole trout (1kg)	20 to 25 min.	whole (200g) 13 to 15 min.	
MEATS/ EGGS	TIME	PREPARATION	REMARKS
Beef	15 to 30 min.		<ul style="list-style-type: none"> • The brown under grill in another dish.
Pork (filet mignon)	25 min.	Joint 800 gr.: 55 to 60 min.	
Poultry (breast, fillet) (Paupiettes)	20 to 25 min.	Chicken drumsticks : 35 to 40 min.	
Sausages	25 min.	Turkey roast joint : 50 to 60 min.	
Black pudding	20 min.	Morteau 400 g piece	
Eggs eggs that are very fresh and stored at room temperature	7 min. 5 to 6 min. 8 min. 10 to 12 min.	<u>Boiled eggs</u> : Place directly on the grill. <u>Fried eggs</u> : broken in an individual dish on the grill and cover with cling film <u>Soft-boiled</u> : Place directly on the grill. Hard / Cocotte see detailed recipes.	
RICE, PASTA COUCOUS	TIME	PREPARATION	REMARKS
Place directly in a dish, covered with water or milk. The steam is not sufficiently wet to saturate these foodstuffs that swell. Place a sheet of aluminium foil over the dish to protect it from the droplets of water.			
Rice pudding	30 min.	100g of washed rice - 20 cl of milk 2 dessertspoons of sugar	<ul style="list-style-type: none"> •Separate grains with a fork at the end of the cooking.
Couscous	20 min.	200g (1/4 litre of water)	

How to maintain your oven

Maintenance

Cavity (after each use)

Wipe out the cavity with a dry cloth after the steam generator has cooled or leave the cavity to dry out with the door open.

Water supply tube (Once per month)

Remove the water supply tube by unscrewing it. Remove any scale that may have formed on the inside (using a fine, pointed object such as a skewer or knitting needle).

Steam generator tube (Once per month)

Pour half a glass of spirit vinegar onto the generator. Leave to work for a few minutes, clean and rinse with water.

Do not use harsh abbrasive cleaners or sharp metal scrapers to clean the oven door glass sinc ethey can scratch the surfaces, wich may result in shattering of glass.

Cleaning the channel

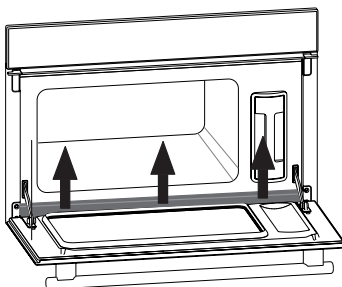

Dismantle this channel by pulling upwards. Wipe it and replace it, using the three notches provided for this purpose.



The oven must not be cleaned with a steam cleaner.

Changing the light bulb ?



The bulb is by the far right corner.

⚠ Always switch the oven off at the mains before changing the bulb in order to safeguard against electric shocks.

- Turn the cover slightly anti-clockwise (left).
- Unscrew the bulb the same way.

The bulb is a :

- 25 W
- 220/240 V
- Type E14 suitable up to 300°C
- Change the bulb and reassemble the unit making sure the seals are positioned correctly.
- Switch the oven back on at the mains.

Troubleshooting

IF YOU REALIZE THAT	POSSIBLE CAUSES	WHAT SHOULD YOU DO?
The display panel is not lit up.	A fault in the oven electrical supply. Electric card out of order.	- Check that the tank has been pushed in completely. - Contact the After-Sales Service.
The light doesn't work.	The bulb needs replacing. The oven is not switched on at the mains. The fuse has blown.	- Change the bulb. - Switch the oven on at the mains. - Change the fuse.
Water or steam leaking from the door during cooking.	The door is not shut correctly. The door seal is faulty.	- Contact the After-Sales Service.

In all cases, if you are unable to solve the problem yourself, please contact the After-Sales Service without delay.