



CM107

Caple Built-in Microwave & Grill



INSTRUCTION MANUAL

1/NOTICES TO THE USER	
• Safety recommendations	3
• Operating principle	4
• Protecting the environment	4
2/INSTALLING YOUR APPLIANCE	
• Before hook-up	5
• Electrical connection	5
• Building in	6
3/DESCRIPTION OF YOUR APPLIANCE	
• The Appliance	7
• Accessories	8
• Control panel	9
• Selectors	10
• Display	11
4/USING YOUR APPLIANCE	
• Timer	11
• Setting and adjusting the time	12
• Stopping the turntable	12
• Programming	13
• Using the power levels	13
• Microwave function	14
• Express Microwave Programme	14
• Reheating on two levels	15
• Keep warm function	15
• Automatic cooking	15
• Guide to automatic functions	16
• Defrosting	18
• Speed Defrost function	19
• Defrosting guide	20
• Grill function	21
• Grill function cooking guide	21
• Microwave + Grill function	22
• Microwave + Grill function cooking guide	22
• Fan heat function	23
• Fan heat cooking guide	24
• Fan heat + Microwave function	25
• Microwave + Fan heat cooking guide	26
• Memory programmes M1 / M2 / M3	26
• Child Safety	27
5/CARING FOR AND CLEANING YOUR APPLIANCE	27
6/TROUBLESHOOTING	28
7/FUNCTIONAL APTITUDE TESTS	29

**Important:**

Keep this user guide with your appliance. If the appliance is ever sold or transferred to another person, ensure that the new owner receives the user guide. Please become familiar with these recommendations before installing and using your appliance. They were written for your safety and the safety of others.

• SAFETY RECOMMENDATIONS

Your appliance is designed for standard household use for cooking, reheating and defrosting foods. The manufacturer declines any responsibility in the case of inappropriate use.

The appliance is not intended to be used by persons (including children) with reduced physical, sensory or mental abilities, or persons lacking experience or awareness, unless using it with the help of a person responsible for their safety, or under supervision and with prior instruction in its use.

Ensure that the cookware is suitable for use in a microwave oven.

To avoid damaging your appliance, never operate it while empty or without the turntable.

Do not interfere with the openings on the lock on the front of the appliance; this could cause damage to your appliance that would require a service call.

The seal and frame of the door must be regularly examined to ensure that they have not deteriorated. If these areas are damaged, discontinue use of the appliance and have a specialised technician check it.

While heating food items in plastic or paper containers, monitor the microwave's contents for there is a risk of spontaneous combustion.

For the microwave and microwave + fan heating functions, the use of metallic cookware, forks, spoons, knives or metal

staples or fasteners for frozen foods is not recommended.

The contents of baby bottles and baby food jars should be shaken or stirred and their temperature checked before consumption to avoid burns.

Never heat a baby bottle with the nipple on (risk of explosion).

Make sure children do not play with the appliance. Do not allow children to use the microwave oven without supervision, unless appropriate instructions have been given so that the child can use the oven safely and understands the dangers of incorrect operation.

Always use oven mitts to remove dishes from the oven. Some dishes absorb the heat of foods and, therefore, are very hot.

Liquids and other foods should not be heated in sealed containers because they may explode.

It is recommended that you avoid heating eggs in their shells and whole hard-boiled eggs in the microwave oven because they run the risk of explosion, even after cooking is complete.

Heating beverages in the microwave oven can cause sudden and/or delayed splattering of boiling liquid, so precautions must be taken when handling their containers.

In the case of small quantities (a sausage, a croissant, etc.) place a glass of water next to the food.

Excessive cooking times may dry out foods and carbonise them. To avoid such incidents, never use the same times recommended for cooking in a traditional oven.

If smoke appears, stop or unplug the oven and leave the door closed to smother any flames that may appear.

• OPERATING PRINCIPLE

The microwaves used for cooking are electromagnetic waves. They are commonly found in our environment in the form of radio-electric waves, light or infrared rays.

Their frequency is in the 2450 MHz range.

Their behaviour:

- They are reflected by metals.
- They travel through all other materials.
- They are absorbed by water, fat and sugar molecules.

When food is exposed to microwaves, its molecules begin moving rapidly, which causes heating.

The penetration depth of waves into the food is approximately 2.5 cm; if the food is thicker, the core of the food will be cooked by conduction, as in traditional cooking.

It is valuable to note that the microwaves trigger within the food a simple thermal phenomenon and that they are not harmful to one's health.

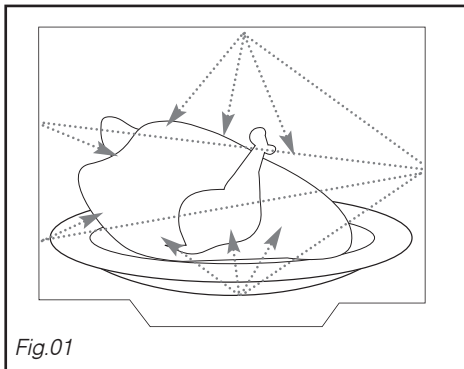

Fig.01

• PROTECTING THE ENVIRONMENT

This appliance's packing materials are recyclable. Recycle them and play a role in protecting the environment by disposing of them in municipal containers provided for this purpose.



Your appliance also contains various recyclable materials. Thus it is stamped with this logo to indicate to you that used appliances should be mixed with other waste. The recycling of appliances organised by your manufacturer will take place under the best conditions, in compliance with European directive 2002/96/CE concerning electrical and electronic equipment waste. Consult your city hall or your retailer to find the drop-off points for used appliances that is nearest to your home. We thank you for your help in protecting the environment.

• **BEFORE HOOK-UP**

 **Warning:**
Ensure that your appliance has not suffered any damage during transport (deformed seal or door, etc...). If you see any kind of damage, before doing anything else, contact your retailer.

In order to easily locate the reference information for your appliance, we recommend that you note these data on the "After-Sales Service Department and Customer Relations" page.

• **ELECTRICAL CONNECTION**

Ensure that:

- The electrical installation has sufficient voltage.
- The electrical wires are in good condition.
- The diameter of the wires complies with the installation requirements.
- Your electrical installation is equipped with 16-ampere thermal-sensitive protection.

In case of doubt, consult your electrician-installer.

The electrical connections are made before the appliance is installed in its housing.

Electrical safety must be provided by a correct build-in. During installation and maintenance operations, the appliance must be unplugged from the electrical grid; fuses must be cut off or removed.

The oven must be connected with a power cable (standardized) with three 1.5 mm² conductors (1 ph + 1 N + ground) that must be connected to a monophasic 220-240 V network via a CEI 60083 standardised receptacle (1 ph + 1 N + ground lead) or in accordance with installation rules. The safety wire (green-yellow) is connected to the appliance's terminal  and must be connected to the ground lead of the electrical set-up.

In the case of connections with an electric receptacle, it must remain accessible after installation of the appliance.

The oven's neutral conductor (blue wire) must be connected to the network's neutral conductor.

In your electrical installation, allow for a user-accessible device that must be able to separate the appliance from the main power supply and whose contact opening is at least 3 mm above all the terminals.

If the power cable is damaged, it should be replaced by the manufacturer, its after-sales service department or by a qualified person to avoid danger.

 **Warning:**
We cannot be held responsible for any accident resulting from an inexistent, defective or incorrect ground lead.

If the oven malfunctions in any way, unplug the appliance or remove the relevant fuse at the oven's connection lead-in.

• BUILDING IN

The oven can be installed under a worktop or in a column of cabinetry (open* or closed) having the appropriate dimensions for *built-in installation* (Fig.02).

Do not use your appliance immediately (wait approximately 1 to 2 hours) after having moved it from a cold location to a hot location because the condensation may cause a malfunction.

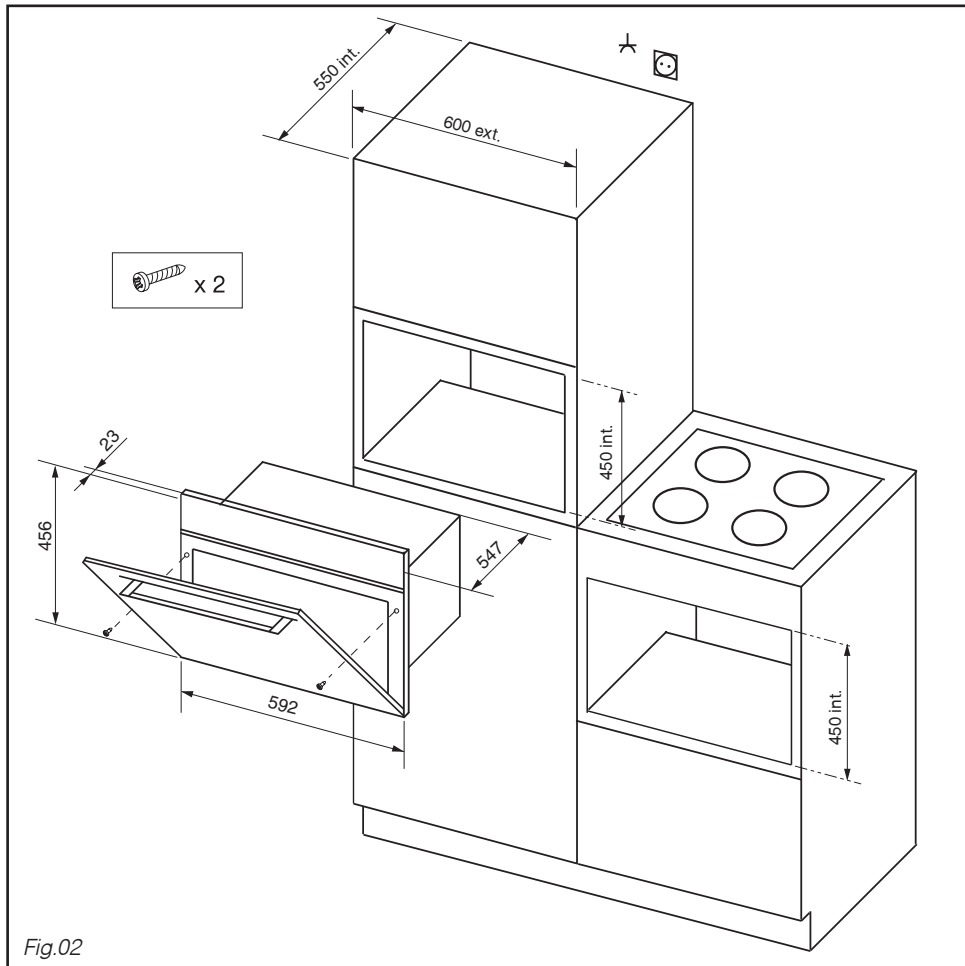

• **THE APPLIANCE**

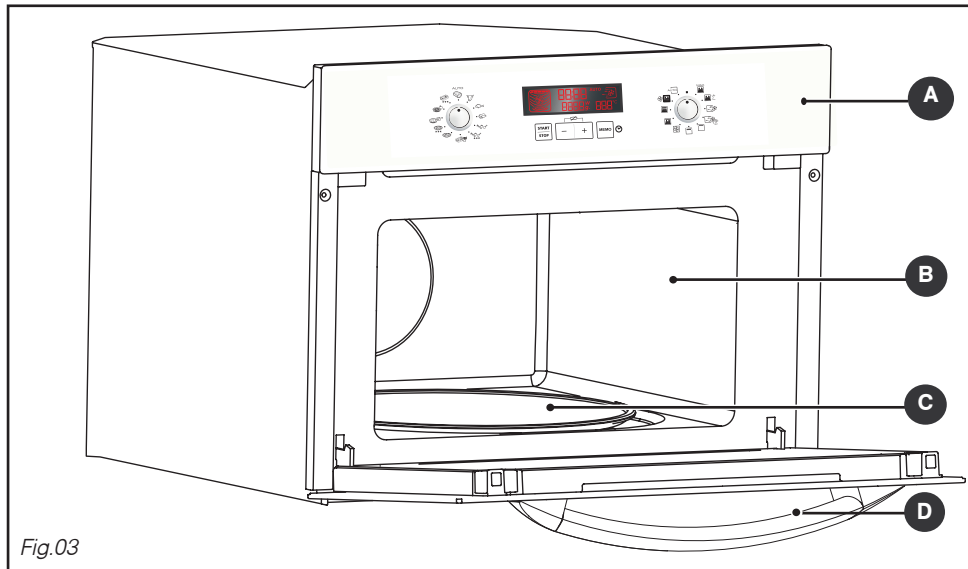

Fig.03

- A Control panel**
- B Cavity**
- C Turntable**
- D Door handle**

• **Turntable:** Enables even cooking of foods with no handling.

It rotates indiscriminately in both directions. If it is not rotating, ensure that all the components are properly positioned.

Do not attempt to rotate it manually; you risk damaging the drive system.

It can be used as a cooking dish. To remove it, take hold of it using the access zones defined in the cavity.

• **The driver:** causes the glass turntable to rotate (Fig.04).

• **The base rollers:** The wheels must be placed in the right direction (Fig.04).

In the event of poor rotation, ensure that there are no foreign matter under the wheels.

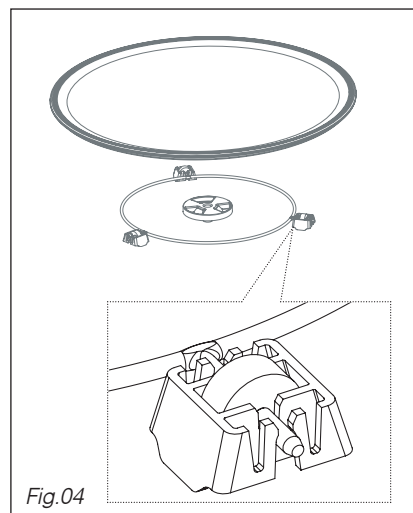
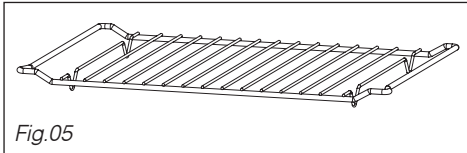

Fig.04

3/DESCRIPTION OF YOUR APPLIANCE

•ACCESSORIES

• **Grid** (Fig.05): Allows you to toast, brown or grill. The grid should not under any circumstances be used with other metal cookware on the microwave, grill + microwave or fan heat + microwave settings. However, you can reheat food in an aluminium tray if you insulate it from the grid using a plate.



• **Side racks** (Fig.06): 2 two shelf supports with hooks allow you to use the grid at three heights.

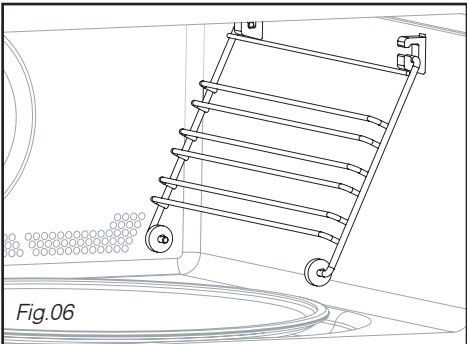

The three insertion heights are available based on the type of cooking and food (Fig.07/08). For the **Grill or Grill + Microwave functions**, use the grid at insertion level 1 for thick foods such as roasts and at insertion level 3 for thinner foods such as chops or sausages.

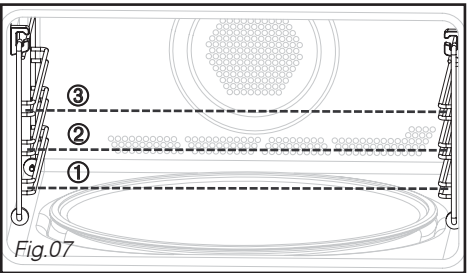

For the **fan heat or microwave + fan heat function**, insert the grid at level 1 or 2 depending on the dish.

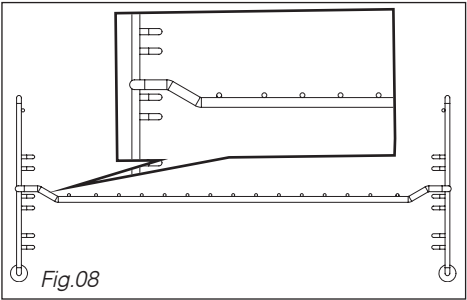

3/DESCRIPTION OF YOUR APPLIANCE

• CONTROL PANEL

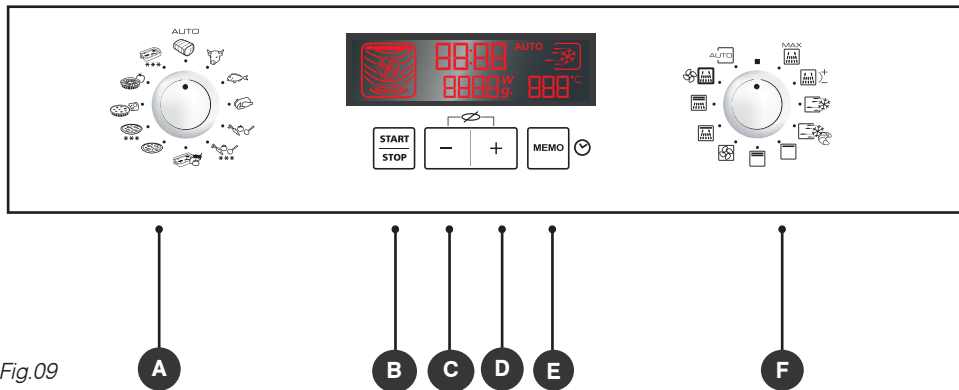

Fig.09

- A** The automatic programme selector allows you to choose the automatic function and the category of food.
- B** The START/STOP touch control allows you to start a programme, and suspend or stop a programme underway.
- C** The “ - / + ” touch controls allow you to set the time, duration of programmes, weight of the food, memorised programmes and the temperature for fan heat cooking programmes.
- D** Pushing both touch controls simultaneously stops the rotation of the turntable to allow for the use of dishes that require all the space available in the oven.
- E** The MEMO touch control lets you programme and initiate the memory function.
Pressing for five seconds allows you to access the CLOCK function to set the time.
- F** The FUNCTION selector lets you choose the programme type.

3/DESCRIPTION OF YOUR APPLIANCE

•SELECTORS

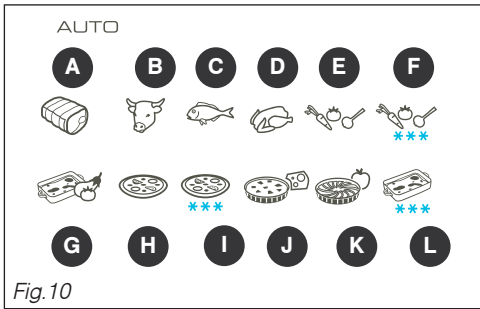

Fig.10

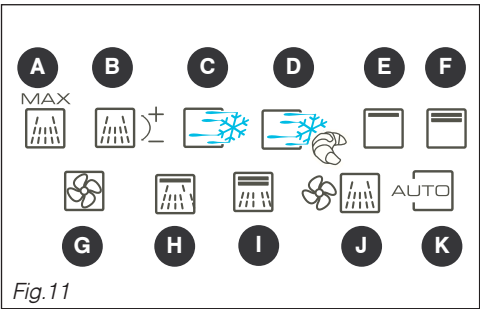

Fig.11

AUTOMATIC PROGRAMME SELECTOR

FUNCTION SELECTOR

- A** PORK, VEAL, TURKEY
- B** BEEF
- C** FISH
- D** POULTRY
- E** VEGETABLES
- F** FROZEN VEGETABLES
- G** FRESH PREPARED MEAL
- H** PIZZA
- I** FROZEN PIZZA
- J** FRESH QUICHE
- K** FRESH TART
- L** FROZEN PREPARED MEAL

- A** 1000 W MICROWAVE
- B** MICROWAVE
- C** SPEED DEFROST
- D** SPEED DEFROST PASTRY/BREAD
- E** LOW GRILL
- F** HIGH GRILL
- G** FAN HEAT
- H** MICROWAVE + LOW GRILL
- I** MICROWAVE + HIGH GRILL
- J** FAN HEAT + MICROWAVE
- K** AUTOMATIC PROGRAMMES

• **DISPLAY**

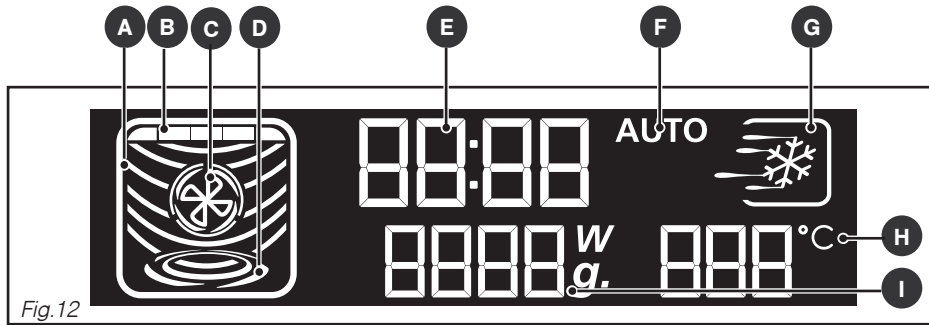

Fig.12

The display guides you through programming the various settings :
 Time, Programme length, Microwave power level (**W**atts),
 Food weight (**g**rams), Stop turntable, Automatic programmes

COOKING ANIMATION depending on the selected function

- | | |
|--------------------------------|----------------------------------|
| A MICROWAVE | F AUTOMATIC PROGRAMMES |
| B GRILL | G SPEED DEFROST |
| C FAN HEAT | H FAN HEATING TEMPERATURE |
| D TURNTABLE | I MICROWAVE POWER |
| E TIME/PROGRAMMING TIME | FOOD WEIGHT |
| | MEMORY 1 / 2 / 3 |
| | CHILD SAFETY |

• **TIMER**

You can also program the "TIMER" function on your microwave oven.

Programming



Turn the selector to the off position.
 Press the +/- touch controls to enter the desired time, e.g. 10 minutes.

Confirm the selection by pressing START/STOP.

The countdown of the entered time begins.

Three beeps are sounded to announce the end of the programme.

To cancel, press START/STOP for two seconds.











Display



• SETTING AND ADJUSTING THE TIME

After hooking up your appliance or after an extended power outage, "12:00" will flash in the display.

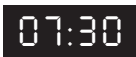
To set the time on the clock		Display
	Press the +/- touch controls to set the time, e.g 6:30.	
	Confirm by pressing the MEMO touch control.	
	There is a beep to confirm that the time has been set.	
To change the time		Display
	Press and hold the MEMO touch control for five seconds. The time display flashes.	
	Enter the new time (e.g. 7:30) by pressing the +/- touch controls.	
	Confirm by pressing the MEMO touch control.	
	There is a beep to confirm that the new time has been set.	



Comments:





If you do not press the MEMO touch control, the time adjustment is cancelled.

Your appliance is equipped with a save function so that the time will continue to be displayed for one day in the event of a power outage.

• STOPPING THE TURNTABLE

If you think that there is not enough space for your dish to rotate freely in the oven, programme the STOP TURNTABLE FUNCTION before or during the programme.

Note: It is not possible to stop the turntable during an automatic defrosting programme.

Programme	Display
 <p>Press the + and - touch controls at the same time; the turntable symbol changes. To cancel this function, repeat the same procedure.</p>	 
 <p>Comments: You must turn the cookware and stir its contents halfway through the programme if the stop turntable function is activated.</p>	

• PROGRAMMING

Your appliance is now hooked up and the correct time is set.

Open the door using the handle. Place the food in the appliance, then close the door.

If the door is not closed properly, the appliance will not function.

Opening the door during operation does not cancel the current programme; it merely suspends it. To restart the oven, close the door and press the START/STOP touch control.



If programming is not followed by any action after one minute, three beeps are sounded to invite you to start or modify the programme. If you do not give any instructions, after one minute the settings are cancelled and you will have to reprogramme.

Press the START/STOP touch control when the door is closed to interrupt the programme.

To cancel the programme, open the door and press START/STOP or press and hold the START/STOP touch control for two seconds with the door closed.

To enter a second programme after the end of the first one, open the door and close it.



Three beeps are sounded to indicate the end of each programme and the time is again displayed in the display panel.

If the door is left open, the light turns off after 10 minutes.

To eliminate moisture, your appliance is equipped with a delayed ventilation function. The oven's ventilation continues to function after the end of the programme. It will stop automatically.



• USING THE POWER LEVELS

Power level	Use
1000 W/900W	Quickly reheating beverages, water and dishes containing a large volume of liquid. Cooking dishes containing alot of water (soups, sauces, tomatoes, etc.).
800 W/700W	Cooking fresh or frozen vegetables.
600 W	Melting chocolate.
500 W	Cooking fish and seafood. Reheating on two levels. Cooking dried beans at low heat. Reheating or cooking fragile, egg-based dishes.
400 W/300W	Low-heat cooking of dairy products, jams.
200 W	Manual defrosting. Softening butter, ice cream.
100 W	Defrosting pastries containing cream.

MICROWAVE OVEN OUTPUT: 1000 W

• MICROWAVE FUNCTION

1000W Direct programming



Turn the function selector to choose the maximum power microwave function. The microwave display lights up; 1000 W appears in the display.

The clock's digits start flashing in the display.



Press the +/- touch controls to adjust the programme time, e.g. 10 minutes.



Confirm the selection by pressing START/STOP. The oven turns on and the programme begins.

Display



1000W

00:00

10:00

Programming by power level



Turn the function selector to choose the variable power microwave function. The maximum power level, 1000 W, flashes in the display.



Press the +/- touch controls to reduce the power of the microwave oven, e.g. 500 W. Confirm the power level by pressing START/STOP; the clock's digits begin flashing in the display.



Press the +/- touch controls to adjust the programme time, e.g. 10 minutes.



Confirm the selection by pressing START/STOP. The oven turns on and the programme begins.

Display



1000W

500W

00:00

10:00



Comments:

If the door is opened during cooking, the oven stops and the remaining time flashes in the display. To continue the programme, simply close the door and press START/STOP.

The duration can be adjusted at any time by simply pressing the + / - touch controls.

• EXPRESS MICROWAVE PROGRAMME

Express programming



Turn the function selector to the stop position, then press the START/STOP touch control for one second to enter an express programme time of 15 seconds.

The microwave operates at its maximum power level (1000 W). The oven turns on and the programme begins.



You can enter an express program ranging up to 2 min 30 s. Up to one minute, each time you press START/STOP adds 15 seconds to the programme. After that, 30 seconds are added until the maximum time of 2 min 30 s is reached.

Display

00:15

02:30



Comments:

After starting the programme, you can modify its duration by pressing the + / - touch controls up to 2 min 30 s.

• REHEATING ON TWO LEVELS

When using the 500W microwave power level function, you can reheat two dishes at the same time. Place one plate on the turntable and the other on the grid inserted level 3



Recommendations:

Cover the plates with plastic food wrap for microwave use or with another inverted plate. The programme times indicated below are given for reheating refrigerated foods or preserved goods at room temperature.

Food type	Quantity	Duration
Foods of uniform consistency, like mashed potatoes, sweet peas, celery, etc.	two 200-g plates	4 - 6 minutes
Foods of uneven consistency, such as cassoulet, stews, ravioli, etc.	two 300-g plates	6 - 8 minutes

• KEEP WARM FUNCTION

If you leave your dish in the oven without opening the door at the end of a programme with microwaves, a “keep warm” function starts up after a couple of minutes to maintain the temperature of your dish. (HH= Heat and Hold) A triple beep after 15 minutes announces the end of the keep warm programme.

• AUTOMATIC COOKING

Thanks to the automatic cooking function, the cooking mode and duration are automatically programmed based on the food type and weight. Nine automatic cooking positions are available using the AUTO selector.

- PORK, VEAL, TURKEY
- BEEF
- FISH
- POULTRY
- VEGETABLES
- FROZEN VEGETABLES

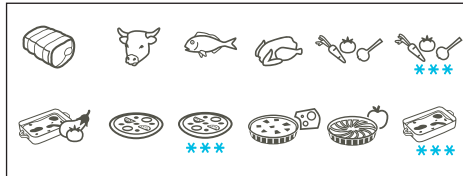

- FRESH PREPARED MEAL
- PIZZA
- FROZEN PIZZA
- FRESH QUICHE
- FRESH TART
- FROZEN PREPARED MEAL

Programming automatic cooking time based on food weight

Display



Turn the function selector to choose the AUTO cooking function. The corresponding display lights up. Turn the AUTO selector to choose the food type you wish to cook, e.g. fish.



100 g flashes in the display.







Press the +/- touch controls to adjust the weight, e.g. 150 g. Confirm by pressing START/STOP.

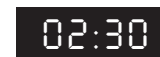







The necessary cooking duration is automatically calculated (e.g. 2 min 30 s). This duration appears in the display. The programme begins.





• **GUIDE TO AUTOMATIC FUNCTIONS**

<p>Pork Veal Turkey</p>  <p>Beef</p> 	<p>This function allows you to cook and brown roasts that weigh 500 g - 2000 g.</p> <p>Cooking is carried out through a combination of the microwave + fan heating and microwave functions.</p> <p>Use a dish suitable for microwave ovens that is heat-resistant, preferably in terra cotta (less splattering than in a glass dish).</p> <p>When possible, cook roasts without fatty exterior layers to avoid smoke and grease splattering. You will achieve better results with leaner roasts.</p> <p>Remove the meat from the refrigerator one hour before placing it in the oven to let it reach room temperature.</p> <p>Place the dish on the grid inserted level 2.</p> <p>To tenderize meat, after cooking, wrap it in aluminium paper and let it set for 10 minutes.</p>
<p>Fish</p> 	<p>This function allows you to cook and brown fish weighing 100g - 1000 g. All fish types can be cooked in the microwave oven. Just make sure that the fish is fresh.</p> <p>Cooking is carried out in the microwave mode.</p> <p>You can cook fish in filets, slices or whole (in this case cut a sliver into the thickest part to obtain best results).</p> <p>Place the fish in a round or oval dish for microwave use, add two to three tablespoons water, lemon juice or white wine and cover with the dish's lid or plastic food wrap; season after cooking.</p> <p>Place the dish on the turntable.</p>
<p>Poultry</p> 	<p>This function allows you to cook and brown a whole chicken or chicken parts (thighs) weighing 500 g - 2000 g.</p> <p>Cooking is carried out using the microwave oven + fan heating or grill mode.</p> <p>Use a dish suitable for microwave ovens that resists high temperatures, preferably in terra cotta (less splattering than in a glass dish).</p> <p>Chicken thighs can be placed directly on a glass drip tray.</p> <p>Before cooking pierce the skin to avoid splattering.</p> <p>Oil, salt and pepper the poultry and sprinkle with spices if desired.</p> <p>Whole chicken: Place the dish on the grid at level 1.</p> <p>Chicken thighs: up to 900 g, place the dish on the grid at level 2.</p> <p>Once cooked, leave the chicken in the oven for five minutes before serving.</p>

• **GUIDE TO AUTOMATIC FUNCTIONS**

<p>Vegetables Fresh</p>  <p>Frozen</p> 	<p>This function allows you to cook vegetables that weight 100 g to 1000 g. Vegetables are cooked with the microwave function.</p> <p>Choose fresh vegetables and before cooking add:</p> <ul style="list-style-type: none"> - up to 200 g: 2 tablespoons water - up to 500 g: 0.5 dl water - up to 1000 g: 1 dl water <p>Use an appropriately-sized dish and cover (except when you are cooking mushrooms). Place the dish on the glass turntable.</p> <p>After cooking, wait a few minutes before serving the vegetables.</p>
<p>Ready-made dishes Fresh</p>  <p>Frozen</p> 	<p>This function allows you to reheat refrigerated ready-made dishes (lasagna, potatoes au gratin, Parmentier casserole, fish gratin, etc.) weighing 100 g to 1000 g.</p> <p>The dishes are reheated using the microwave function.</p> <p>Remove the product from its packaging and place in an appropriately sized, microwave safe dish that is heat-resistant. For better results, cover the microwave-safe dish with microwave plastic food wrap or with another inverted plate.</p> <p>Place the dish on the turntable. Wait two minutes before serving to allow for even heat distribution.</p>
<p>Pizza - Fresh</p>  <p>Frozen</p>	<p>Remove the pizza from its packaging and place it directly on the grid inserted level 2.</p> <p>The weight to be entered should correspond to the pizza's <u>actual</u> weight.</p> <p>The fresh pizza function is used for pizzas weighing 100 g to 750g.</p> <p>Fresh pizza is cooked using the microwave + fan heating function.</p> <p>The frozen pizza function is used for pizzas weighing 100 g to 700g.</p>
<p>Fresh Tarts</p> 	<p>This function allows you to cook and brown fresh tarts from 27 to 30 cm in diameter.</p> <p>Cooking is carried out through the microwave oven + fan heating mode.</p> <p>Use a microwave-safe tart mould that is heat-resistant (in Pyrex glass, porcelain, etc.).</p> <p>When you use ready-made crust, do not remove the parchment paper.</p> <p>Cut the excess paper to the dimensions of the dish.</p> <p>Place the tart mould on the grid inserted level 2.</p> <p>Tips: Do not use a metallic mould.</p>
<p>Fresh Quiche</p> 	<p>This function allows you to cook and brown fresh quiches from 27 to 30 cm in diameter.</p> <p>Cooking is carried out through the microwave oven + fan heating mode.</p> <p>Use a microwave-safe tart mould that is heat-resistant (in Pyrex glass, porcelain, etc.).</p> <p>When you use ready-made crust, do not remove the parchment paper.</p> <p>Cut the excess paper to the dimensions of the dish.</p> <p>Place the tart mould on the grid inserted level 2.</p> <p>Tips: Do not use a metallic mould.</p> <p>Begin cooking the quiche as soon as the filling has been poured into the crust. Never let the crust soak or it will not cook properly.</p>

• DEFROSTING

Using your microwave oven to defrost frozen vegetables enables you to save a lot of time. To defrost food, use the SPEED DEFROST   function or the MICROWAVE function set to power level 200 W (defrost).

Note:

Small cuts of meat and fish can be cooked immediately after defrosting. Larger cuts such as meat roasts or whole fish will still be slightly frozen at the end of the defrost programme. We recommend that you let them sit for a period at least as long as the defrosting time so that they reach a uniform temperature.

Foods covered with ice crystals will take longer to defrost. In this case, you can increase the defrost time.

Recommendations:

The defrost time depends on the appliance type. It also depends on the shape, size, initial temperature and quality of the food.

In most cases, food should be removed from its packaging. Remember to remove the metal staples from packaging.

Halfway through the defrost time, the pieces should be turned over, mixed and separated if they were frozen together.

If you defrost large pieces of meat or fish that prevent the rotation of the turntable, engage the Stop Turntable function. If you do this, remember to stir food regularly.

Defrost the meat and fish by placing it on an upside-down saucer positioned on a plate; this allows juices to flow out. If it stays in contact with the food, it will overheat.

Never refreeze food unless it has been cooked.

Length of defrost programmes:

The durations of defrost programmes were calculated based on food frozen at -18°C. This gives you an indication of the required defrosting time, but the actual duration may vary based on the thickness, shape, size and packaging of the food.

Choosing a programme :

Two automatic defrost programmes are available:



defrosting meats, poultry, fish, vegetables, ready-made dishes







defrosting bread and pastry



Choose the 200 W microwave function (defrosting power level) if you want to defrost quantities that are not covered by the SPEED DEFROST programmes. Enter the desired defrosting time. You can refer to the following table for suggested defrosting times.

• SPEED DEFROST FUNCTION

Choose the type and quantity of food that you wish to defrost and the automatic function will programme the appropriate defrosting time.

Speed defrost	Display
 <p>Turn the function selector to choose the "Speed Defrost" function. The corresponding display lights up. 50 g appears in the display.</p> <p>Press the +/- touch controls to adjust the weight, e.g. 400 g. Confirm the selection by pressing START/STOP.</p> <p>The necessary programme time is automatically calculated (e.g. 6 min 30 s). The time appears in the display with the appropriate functions for defrosting. The programme begins.</p>	   



Comments:

Proceed in the same manner for breads and pastry, choosing the specific Speed Defrost function .

The defrost time is automatically calculated based on the weight of the food.

This may depend on the initial temperature of the food (the times are calculated for food frozen at -18°C).

For foods weighing over 350 g (except for bread/pastry), a beep is sounded halfway through the Speed Defrost programme to remind you that it is time to turn over the food to achieve better results; the word "turn" is displayed. After turning the food, close the door and press START/STOP to continue the defrosting programme.

With the Speed Defrost function, the defrost time cannot be modified.

To achieve even results, the **STOP TURNTABLE** function cannot be used with the Speed Defrost function.

As for foods that do not appear in the food category recommendations, use the 200 W MICROWAVE function. Refer to the comments below to find the recommended programme times.

• DEFROSTING GUIDE

Defrosting pastry

Food	Quantity	Time	Recommendations
Flaky or shortcrust pastry	400 g	1 - 3 min	Place on kitchen paper and turn halfway through defrosting

Defrosting shellfish

Food	Quantity	Time	Recommendations
Scallops	500 g	5 - 7 min	Place on a plate, mix halfway through defrosting.
Peeled prawns	100 g	1 - 2 min	
Whole pink prawns	200 g	2 - 4 min	
Langoustine / Gambas (10)	500 g	6 - 8 min	

Defrosting fish, meat and vegetables

Food	Quantity	Time
Fish: whole/fillets/steaks	100 g	1 - 2 min
	200 g	3 - 5 min
	400 g	5 - 7 min
	500 g	7 - 9 min
	750 g	12 - 14 min
	1000 g	17 - 19 min
Turkey/pork/veal/beef/poultry Roasted/sliced/in pieces, etc.	100 g	1 - 2 min
	200 g	3 - 5 min
	400 g	5 - 7 min
	500 g	7 - 9 min
	750 g	12 - 14 min
	1000 g	17 - 19 min
	1250 g	23 - 25 min
	1500 g	28 - 30 min
Cauliflower/broccoli/carrots/mushrooms/ mixed vegetables, etc.	500 g	7 - 9 min
	750 g	12 - 14 min
	1000 g	17 - 19 min

Defrosting fruit

Food	Quantity	Time
Strawberries	250 g	7 - 9 min
Raspberries/sour cherries	250 g	6 - 8 min
Gooseberries/blueberries/blackcurrants	250 g	5 - 7 min

• GRILL FUNCTION

This function enables you to cook and brown foods such as au gratin dishes and meats. It can be used before or after cooking, depending on the recipe.



Please note:

The accessible areas of the oven can become hot when the grill is used. It is advisable to keep small children under supervision.

If the appliance is being used in combined mode, it is recommended that children only use the oven under adult supervision because of the temperatures generated.

When using the grill, you must protect your hands when removing dishes and use cookware that is heat-resistant, such as Pyrex glass or ceramic.

There are two grill settings: LOW GRILL and HIGH GRILL.

As a general rule, it is recommended that you use the HIGH GRILL setting to grill meats and fish and the LOW GRILL setting in the grill + microwave mode to brown or crisp more delicate food. Insert the grid based on the height of the cookware or the food.

Programming the GRILL function



Turn the selector to choose the Grill function, e.g. High Grill. The grill display lights up.

The clock's digits start flashing in the display.



Press the +/- touch controls to adjust the programme time, e.g. 10 minutes.



Confirm the selection by pressing START/STOP. The oven turns on and the programme begins.

Display



Comments:

The duration may be adjusted at any time by simply pressing the +/- touch controls.

• GRILL FUNCTION COOKING GUIDE









Place the food on the grid inserted level 3. Turn the food over midway through the programme.

Food	Quantity	Duration
Chitterlings sausage, black pudding, sausages (<i>pierce them with a fork</i>)	4 - 6 pieces	22 - 30 minutes
Pork chops	4 pieces	27 - 32 minutes
Lamb chops	4 pieces	15 - 17 minutes
Beef spare ribs	800 g	23 - 25 minutes
Smoked bacon	4 - 6 slices	18 - 25 minutes

• MICROWAVE + GRILL FUNCTION

This function lets you simultaneously use the grill and the microwave, which enables quick cooking. You can use any of the grid levels with any microwave power level settings up to 700 W.

Programming the GRILL + MICROWAVE FUNCTION

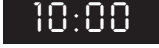
		Display
	Turn the selector to choose the LOW GRILL or HIGH GRILL + MICROWAVE setting, e.g. LOW GRILL + MICROWAVE. The corresponding display lights up and the maximum microwave power level, 700 W, flashes in the display.	 
 	Press the +/- touch controls to reduce the power of the microwave oven, e.g. 500 W. Confirm the power level by pressing START/STOP; the clock's digits begin flashing in the display.	
 	Press the +/- touch controls to adjust the programme time, e.g. 10 minutes. Confirm the selection by pressing START/STOP. The oven turns on and the programme begins.	 



Comments:

The duration can be adjusted at any time by simply pressing the +/- touch controls.

• MICROWAVE + GRILL FUNCTION COOKING GUIDE

Use a dish suitable for microwave ovens that is heat-resistant, preferably in terra cotta (less splattering than in a glass dish).

Place the food in a dish and place it on the grid inserted level 1. Turn the food over midway through the programme.









When possible, cook roasts without fatty exterior layers to avoid smoke and grease splattering.

To tenderize meat, season the roast after cooking, wrap it in aluminium paper and let it set for 10 minutes.

Food	Quantity	Programme	Duration
Lamb shoulder (boned and tied)	1300 g	200 W + GL 3	40 - 45 min
Boneless rib steak	800 g	200 W + GL 3	18 - 23 min
Chicken, Guinea fowl	1200 g	500 W + GL 3	25 - 27 min
Roast turkey	800 g	300 W + GL 3	27 - 32 min
Pork roast	1000 g	300 W + GL 3	35 - 40 min
Roast veal	1200 g	300 W + GL 2	50 - 55 min

• FAN HEAT FUNCTION

The fan heat function allows you to cook and brown foods like in a traditional oven.

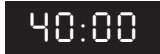
Programming the FAN HEAT function	Display
 <p>Turn the selector to choose the FAN HEAT function. The corresponding display lights up; the temperature (200°C) flashes in the display.</p>	
 <p>Press the +/- touch controls to choose the programme temperature, e.g. 180° C. Confirm the temperature by pressing START/STOP.</p>	
 <p>The clock's digits start flashing in the display.</p>	
 <p>Press the +/- touch controls to adjust the programme time, e.g. 40 minutes.</p>	
 <p>Confirm the selection by pressing START/STOP. The oven turns on and the programme begins.</p>	



Comments:

The duration may be adjusted at any time by simply pressing the +/- touch controls.

“°C” flashes until the programme temperature is reached .

You can preheat your microwave oven for fan heat programmes just as you would a traditional oven.



Please note:

Never preheat your oven in the Fan Heat + Microwave mode because this could damage the appliance.



Recommendations:

The cooking temperature can be adjusted in increments of 10°C, from 50°C to 250°C.

The cooking time ranges from 0 to 90 minutes.

It is preferable to enter a minimum time and then to add time if necessary; monitor the colour of foods.

Always insert the grid at level 1 or level 2; this will optimise heat distribution and the quality of the cooking.

Use cookware designed to be heat-resistant.

Protect your hands when you remove the dish because the cookware may reach high temperatures.

If you want to defrost food after using the fan heat function, we recommend that you let your oven cool down for 10 minutes; this will give you better results.

• FAN HEAT COOKING GUIDE

* Preheat the oven to the temperature indicated.

Food	Temperature	Grid level	Duration
Meat			
Pork roast (1 kg)	160°C	On the grid at level 2	90 min
Veal roast (1 kg)	180°C	On the grid at level 2	70 - 75 min
Roast beef (1 kg)	220°C*	On the grid at level 2	38 - 40 min
Lamb (leg, shoulder, 1.5 kg)	180°C	In a dish at level 2	50 - 60 min
Poultry (1.2 kg)	180°C	On the grid at level 1	70 - 75 min
Large poultry	180°C	On the grid at level 1	90 - 120 min
Rabbit	230°C	In a dish at level 2	40 - 45 min
Fish (1.2 kg)			
Whole (snapper, salmon, whiting)	180°C	In a dish at level 2	35 - 45 min
Vegetables			
Potatoes au gratin	180°C	On the grid at level 2	50 - 55 min
Lasagna	180°C	On the grid at level 2	40 - 45 min
Stuffed tomatoes	180°C	On the grid at level 2	45 - 55 min
Pastry			
Savoie cake	150°C	On the grid at level 2	35 - 45 min
Genovese cake	150°C	On the grid at level 1	35 - 45 min
Genovese roll	150°C	In a dish at level 2	20 - 25 min
Cake	160°C	On the grid at level 1	40 - 50 min
Biscuits	180°C	In a dish at level 2	18 - 22 min
Cookies	160°C	In a dish at level 2	20 - 25 min
Cream	160°C	On the grid at level 2	35 - 45 min
Madeleines	170°C	In a dish at level 2	Double-boiler 20 - 30 min
Pound cake	170°C	On the grid at level 2	40 - 50 min
Cheesecake	170°C	On the grid at level 1 springform mould, 26 cm diameter	65 - 75 min
Kouglof	180°C	On the grid at level 1 in a special mould	45 - 50 min
Puff pastry	180°C	In a dish at level 2	35 - 40 min depending on size
Short crust tart	200°C	On the grid at level 2	40 - 45 min
Flaky crust tart	250°C*	On the grid at level 2	30 - 40 min
Miscellaneous			
Pâté in terrine (1 kg)	190°C	On the grid at level 1	90 min
Savoury tarts	170°C	On the grid at level 2 20 cm mould	55 - 65 min
Stewed dishes (ragout, bœeufsteak)	160°C	On the grid at level 1, depending on the dish	90 - 180 min
Bread (500 g flour)	220°C*	On the grid at level 2	25 - 30 min

• FAN HEAT + MICROWAVE FUNCTION

The fan heat + microwave cooking mode combines microwave cooking with fan heat cooking, which allows you to save considerable time.

The following microwave power levels are available : 100-200-300-400-500 W.

The cooking temperature can be adjusted in increments of 10°C, from 50°C to 250°C.

The cooking time can be set between 0 and 60 minutes.

Programming the FAN HEAT + MICROWAVE function



Turn the selector to choose the FAN HEAT + MICROWAVE function. The corresponding display lights up, the maximum microwave oven power, 500 W, flashes in the display



Press the +/- touch controls to reduce the power of the microwave oven, e.g. 300 W. Confirm the power level by pressing START/STOP; the temperature (200°C) flashes in the display.



Press the +/- touch controls to choose the programme temperature, e.g. 180° C. Confirm the temperature by pressing START/STOP; the clock's digits begin flashing in the display.



Press the +/- touch controls to adjust the programme time, e.g. 40 minutes. Confirm the selection by pressing START/STOP.

The oven turns on and the programme begins.

Display



Comments:

The duration may be adjusted at any time by simply pressing the +/- touch controls.

Until the programme temperature is reached, the "°C" symbol flashes.

A beep is sounded to indicate that the programme temperature has been reached and the "°C" symbol stops flashing.

You can preheat your microwave oven for fan heat programmes just as you would a traditional oven.



Please note:

Never preheat your oven in the Fan Heat + Microwave mode because this could damage the appliance.



Recommendations:

When using the oven in the combined fan heat + microwave mode, do not use metal cookware.

Cooking on two levels :

To simultaneously cook an 800 g roast veal and 800 g of potatoes au gratin, set the appliance as follows : 55 minutes at 170°C, microwave power level at 300 W. We recommend that you place the potatoes on the turntable and the roast veal on a dish inserted at level 3.

• MICROWAVE + FAN HEAT COOKING GUIDE

Use a dish suitable for microwave ovens that is heat-resistant, preferably in terra cotta (less splattering than in a glass dish).







When possible, cook roasts without fatty exterior layers to avoid smoke and grease splattering.

After cooking, season the roast, wrap it in aluminium paper and let it sit for 10 minutes. The roast will be juicier.

Food	Qty	Programme MICROWAVE + FAN HEATING	Duration (min)	Recommendations
Lamb shoulder on the bone	1300 g	200 W + 200°C	32 - 37	In a dish, on the grid, level 2
Boneless rib steak	800 g	200 W + 200°C	23 - 28	In a dish, on the grid, level 2
Chicken, guinea fowl	1200 g	200 W + 200°C	35 - 40	In a dish, on the grid, level 1
Roast turkey	800 g	300 W + 180°C	32 - 37	In a dish, on the grid, level 2
Pork roast	1200 g	300 W + 180°C	47 - 52	In a dish, on the grid, level 2
Veal - roast	1000 g	300 W + 180°C	37 - 42	In a dish, on the grid, level 2

• MEMORY PROGRAMMES M1 / M2 / M3

The three memory functions allow you to record three common programmes that you can then select rapidly.

Programming a memory touch control		Display
	Access the memory function by pressing the MEMO touch control. M1 flashes. (Press the touch control again to switch to M2... M3.) Enter the cooking programme of your choice.	
	Instead of pressing START/STOP, confirm your programme by pressing the MEMO touch control for a second. M1 (M2/M3) is displayed and a beep confirms the programme was saved.	
Using a memorised programme		Display
	Press the MEMO touch control ; M1 is displayed. Choose memory programme M2 or M3 by again pressing the touch control . The memorised programme is displayed.	
	Confirm the selection by pressing START/STOP, the oven turns on and the programme begins.	





Comments:

Follow the same procedure to cancel and replace the previously entered programme. You can use the memory feature for all functions except for automatic programmes.

• CHILD SAFETY

You can activate the “CHILD SAFETY” function to prevent the unauthorised use of your microwave oven.

Programming	Display
 <p>Open the door and press the START/STOP touch control for five seconds, until the key symbol appears in the display. Two beeps are sounded to confirm that your microwave oven is temporarily locked.</p> <p>No programmes are available.</p>	
<p>To cancel: Follow the same procedure:</p>  <p>Press the START/STOP touch control for five seconds with the door open. The key symbol disappears and the clock is displayed.</p> <p>Two beeps are sounded to confirm the procedure.</p>	

5/CARING FOR AND CLEANING YOUR APPLIANCE

It is recommended that you regularly clean your oven and remove any food build-up on the inside and outside of the appliance. Use a damp, soapy sponge. If the appliance is not cleaned regularly, its surface could become damaged, permanently affecting the appliance's lifespan and possibly causing a safety hazard. If the door or door hinge are damaged, the oven should not be used until it has been repaired by an authorised person.

Do not clean the appliance with a steam cleaner.

The use of abrasive products, alcohol or thinner is not recommended; they may damage the appliance.

In the event of odour or caked-on dirt, boil water with lemon juice and vinegar in a cup for two minutes and clean the insides with a bit of dishwashing liquid.

To clean the ceiling of your oven cavity, tilt the grill resistor downward (*fig. 13*). Remove the grill resistor by pressing on the stem in the upper left (*fig. 14*).

The table can be removed to facilitate cleaning. To do this, use the access zones provided for this purpose. If you remove the drive, do not let water penetrate into the the motor axle hole.

Don't forget to return the drive, base rollers and turntable.

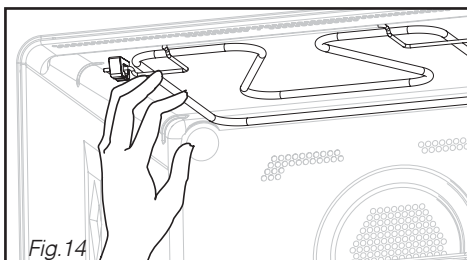
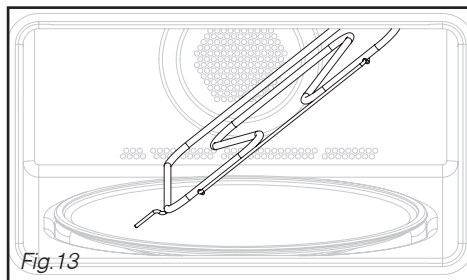

6/TROUBLESHOOTING

If you have doubts about the proper functioning of your appliance, this does not necessarily mean that there is a breakdown. In any event, check the following items:

You observe that ...	What should you do?
The time counts down, but the appliance is not working (the turntable is not rotating and food is not heated). "Time/demo" flash alternately in the display.	Your appliance is in DEMONSTRATION mode. Simultaneously press the START/STOP , "+" and "-" touch controls for five seconds.
The appliance does not start.	Check the electrical connection of your appliance. Ensure that your oven's door is fully closed. Ensure that the child safety feature  is not activated.
The appliance continues to make noise after the end of the cooking time.	To evacuate residual water vapour, your appliance is equipped with a delayed ventilation feature. The fan continues to function for 15 minutes after the end of the programme.
The appliance is noisy. The turntable does not rotate properly.	Clean the wheels and the rolling area under the turntable. Ensure that the wheels are properly positioned.
You see steam on the window.	Wipe the condensation away with a cloth.
Food is not heated during a microwave programme.	Ensure that the cookware is suitable for microwave ovens and that the power level is appropriate.
Smoke comes from the grill at the beginning of a programme.	Remove all cooking residue from the heating element before each use.
The appliance is creating sparks.	Thoroughly clean the appliance: remove grease, cooking particles, etc. Remove any metal items from the walls of the oven. Never use metal items with the grid.

EN 7/FUNCTIONAL APTITUDE TESTS

Functional aptitude tests in accordance with CEI/EN/NF EN 60705 norms 60705.
 The International Electrotechnical Commission, SC.59K, has established a standard for comparative performance tests conducted on various microwave ovens.
 We recommend the following for this appliance:

Test	Load	Approx. time (min)	Power level	Cookware / Tips
Set custard (12.3.1)	1000 g	16 - 18	500 W	Pyrex 227 On the turntable
	750 g	13 - 15		Pyrex 220 On the turntable
Savoie cake (12.3.2)	475 g	6 - 7	700 W	Pyrex 827 On the turntable
Meat loaf (12.3.3)	900 g	14	700 W	Pyrex 838 Cover with plastic film. On the turntable
Defrosting meat (13.3)	500 g	11 - 12	200 W	On the turntable
Defrosting raspberries (B.2.1)	250 g	6 - 7	200 W	On a flat plate On the turntable
Potatoes au gratin (12.3.4)	1100 g	23 - 25	Low grill + 700 W	Pyrex 827 On the turntable
Chicken (12.3.6)	1200 g	24 - 26	High grill + 500 W	Place on the grid inserted at level 1 (from the bottom) Turn midway through
		35 - 40	Fan heat 200°C + 200 W	In an enamelled earthenware dish Place on the grid inserted at level 1 (from the bottom)
Cake (12.3.5)	700 g	20	Fan heat 220°C + 200 W	Pyrex 828 Place on the grid at level 1

EN After Sales Service:

Any maintenance on your equipment should be undertaken by:

- either your dealer,
- or another qualified mechanic who is an authorized agent for the brand appliances.

When making an appointment, state the full reference of your equipment (model, type and serial number). This information appears on the manufacturer's nameplate attached to your equipment.