

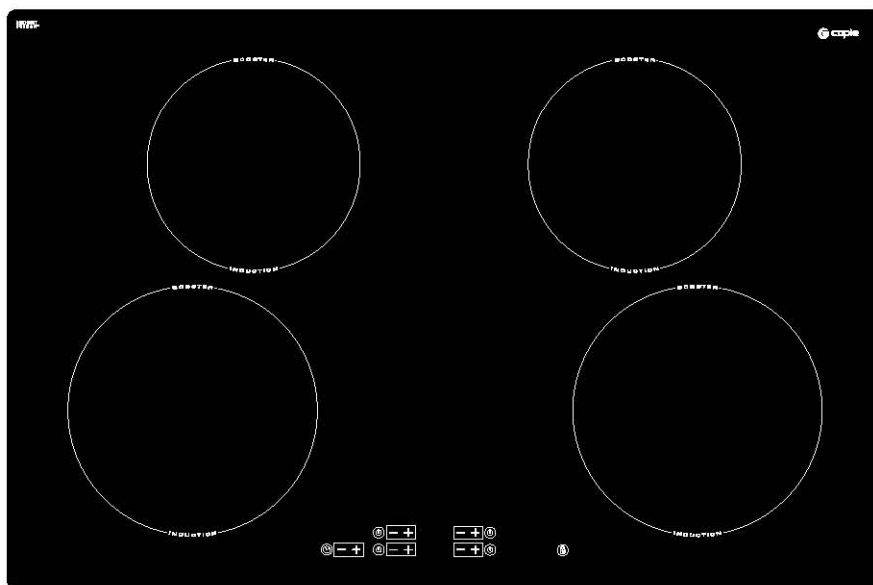

C8611

Caple Induction Hob 77cm



INSTRUCTION MANUAL

- Safety Guidelines _____ 4
- Environmental Protection _____ 4
- After Sales Service _____ 5
- Description of Your Appliance _____ 5

- 1 / INSTALLING YOUR APPLIANCE**
- Proper positioning _____ 6
- Building in _____ 6
- Hook-up _____ 7

- 2 / USING YOUR APPLIANCE**
- Description of the top _____ 8
- Cookware for induction _____ 9
- Which cooking zone should you use based on your cookware? _____ 9
- Description of control panel _____ 10
- Powering on /Stop _____ 10
- Adjusting the power _____ 10
- Adjusting the timer _____ 10
- child safety use _____ 11
- Safety during operation _____ 12

- 3 / DAILY CARE OF YOUR APPLIANCE**
- Protecting your appliance _____ 13
- Maintaining your appliance _____ 13

- 4 / SPECIAL MESSAGES, DIFFICULTIES**
- During initial use _____ 14
- When powering on _____ 14
- During operation _____ 14

- 5 / COOKING CHART**
- Cooking chart for food types _____ 15

As part of our commitment to constantly improving our products, we reserve the right to make changes to them based on technical advances to their technical and functional features and appearance.

 Warning
Before installing and using your appliance, please carefully read this Guide to Installation and Use, which will allow you to quickly familiarise yourself with its operation.

• SAFETY GUIDELINES

We have designed this cooking hob for use by private persons in their homes.

These cooking hobs are meant to be used exclusively for cooking beverages and foodstuffs and do not contain any asbestos-based materials.

• Residual heat

A cooking zone can remain hot for several minutes after use.

An "H" is displayed during this period.

Avoid touching the hot areas during this time.

• Child safety device

Your hob is equipped with a child safety device that locks its operation after use or during cooking (See " Child Safety use" section).

Do not forget to unlock it before using the hob again.

• For users of pacemakers and active implants

The functioning of the hob conforms to current electromagnetic interference standards and thus is in total compliance with legal requirements (89/336/CEE directives).

In order to avoid interference between your cooking hob and a pacemaker, your pacemaker must be designed and programmed in compliance with the regulations that apply to it.

Consequently, we can only guarantee that our own product is compliant.

With regard to the compliance of the pacemaker or any potential incompatibility, you can obtain information from the manufacturer or your attending physician.

For Australia only :

- Young children should be supervised to ensure that they do not play with the appliance.
- The appliance is not intended for use by young children or infirm person without supervision.
- If the supply cord is damaged, it must be replaced by the manufacturer or its service agent or a similarly qualified person in order to avoid hazard.
- Do not install the product if you see any damage on it.

For Service issues, phone number : 1300 553 720, fax number : 1300 553 719



Electrical Danger

Ensure that the power cables of any electrical appliances plugged in close to the hob are not in contact with the cooking zones.

If a crack appears in the glass worktop, immediately disconnect your appliance to avoid the risk of electric shock.

To do this, remove the fuses or use the circuit breaker.

Do not use your hob until you have replaced the glass worktop.

• ENVIRONMENTAL PROTECTION

This appliance's packaging material is recyclable. Help recycle it and protect the environment by dropping it off in the municipal receptacles provided for this purpose.



Your appliance also contains a great amount of recyclable material. It is marked with this label to indicate the used appliances that should not be mixed with other waste. This way, the appliance recycling organised by your manufacturer

will be done under the best possible conditions, in compliance with European Directive 2002/96/EC on Waste Electrical and Electronic Equipment. Contact your town hall or your retailer for the used appliance collection points closest to your home.

We thank you doing your part to protect the environment.

Any maintenance on your equipment should be undertaken by:

- either your dealer,
- or another qualified mechanic who is an authorized agent for the brand appliances.

When making an appointment, state the full reference of your equipment (model, type and serial number). This information appears on the manufacturer's nameplate attached to your equipment.

• DESCRIPTION OF YOUR APPLIANCE

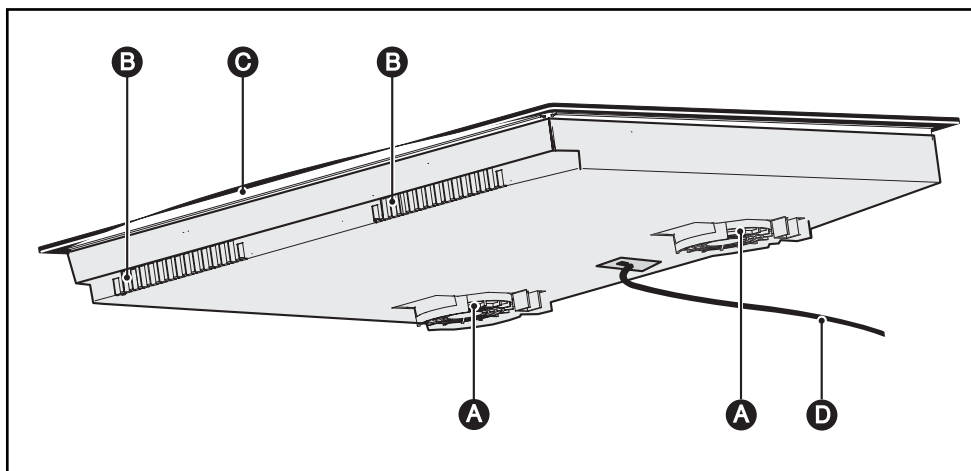

- A** Air intake
- B** Air outlet
- C** Vitroceramic glass
- D** Power cord

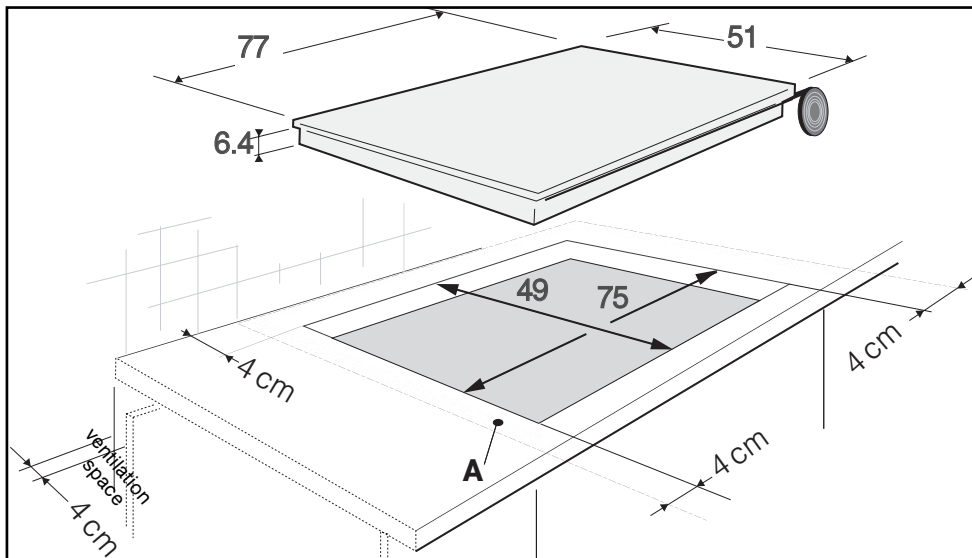

• PROPER POSITIONING

Your appliance should be positioned so that the plug-in unit is accessible.

The distance between the edge of your appliance and the side and rear walls (or partitions) must be at least four centimetres (area A).

Your appliance can be easily integrated above a cabinet, an oven or a build-in-ready household appliance. You must simply ensure that the air intakes and air outlets are clear (See "Description of Your Appliance" section).

• BUILD-IN

Follow the diagram above.

Glue the foam seal underneath your appliance by following the outline of the worktop upon which your appliance will rest. This will allow you to achieve an airtight seal with the worktop.

Attach the clips to the hob.*

* depending on the model



Tip

If your oven is located below your hob, the hob's thermal safety measures forbid the simultaneous use of the hob and the pyrolysis program of your oven. Your hob is equipped with an anti-overheating safety device.

This safety can be activated, for example, when the hob is installed over an oven that is not sufficiently insulated. If this occurs, a series of small lines appear in the control panel. In this case, we recommend that you increase the ventilation of your hob by creating an opening in the side of your cabinet (8 cm x 5 cm) and/or that you install the oven insulation kit (reference 75X1652) that is available from the Post-Sales Service Department.



Warning

You must ensure that the air intakes located under your cooking appliance remain clear at all times.

For all types of installation, your induction hob needs proper ventilation.

For models and 80cm, make sure that the cross member of the unit does not block the flow of air. If necessary, use a bevel.

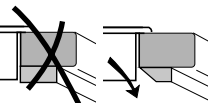

• HOOK-UP

These hobs must be connected to the power grid via an electrical outlet that complies with EIC publication 60083 or an all-pole cut-off device that complies with installation regulations in effect.

When power is first supplied to your hob, or after an extended power outage, an indicator light will appear on the control panel. It automatically disappears after approximately 30 seconds, or as soon as any touch control on the control panel is pressed. This display is normal and, if needed, serves as an indication to the after-sales service staff. In all cases, the user of the hob should disregard it.



Warning

If the power cable is damaged, it should be replaced by the manufacturer, its after-sales service department or by a person with similar qualifications to avoid danger.

• 220-240 V monophase hook-up ~ -

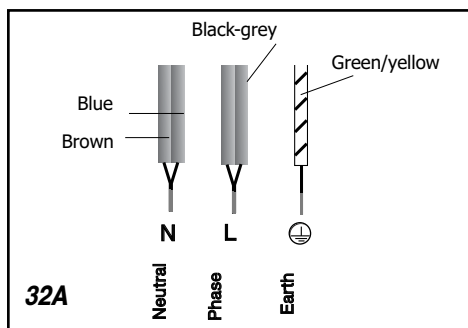

• hook-up 400V 2N ~ - 16A

Separate the two phase wires (L1 and L2) before hooking up.

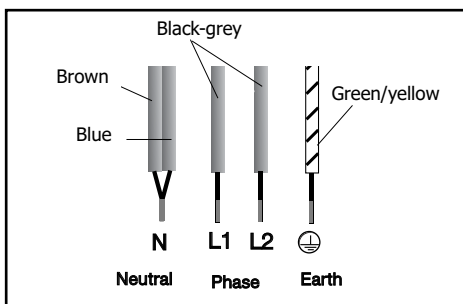

For a 400 V 2N triphase hook-up, if your hob malfunctions, check that the neutral conductor is properly connected.

- **DESCRIPTION OF THE TOP**

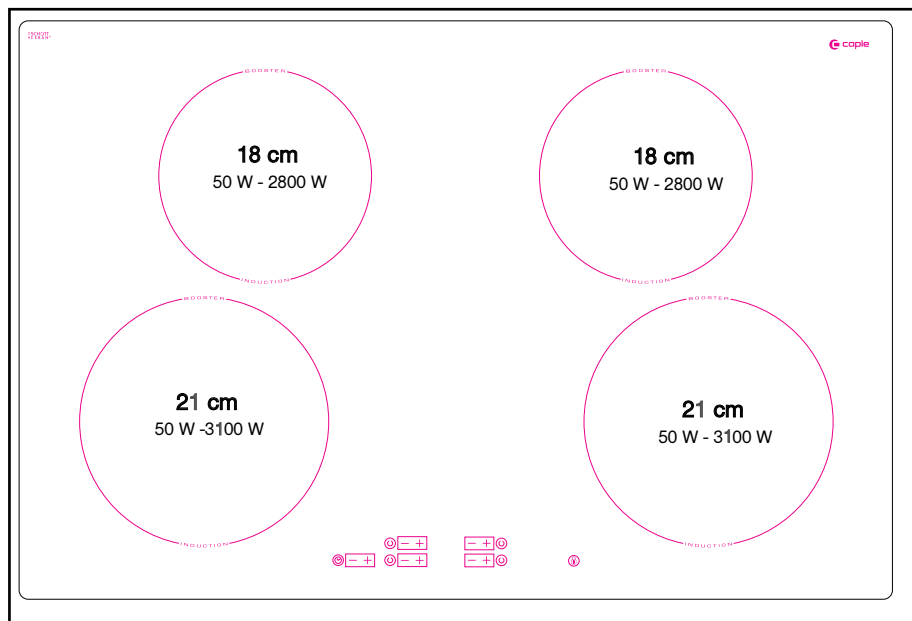

C861I

• COOKWARE FOR INDUCTION

• The induction principle

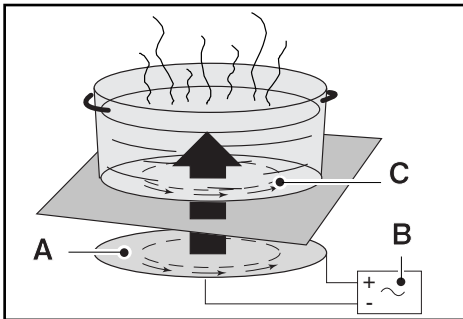

- A** Inductor
- B** Electronic board
- C** Induced electric current

The principle of induction is based on a magnetic phenomenon.

When you place your cookware on a cooking zone and you turn it on, the electronic boards in your cooking hob produce "induced" currents in the bottom of the cookware and instantly raise its temperature. This heat is then transferred to the food, which is simmered or seared depending on your settings.

• Cookware

Most cookware is compatible with induction. Only glass, terra cotta, aluminium without a special finish on the bottom, copper and some non-magnetic stainless steels do not work with induction cooking.

We recommend that you select cookware with a thick, flat bottom. The heat will be distributed better and cooking will be more uniform.



By choosing cookware that displays this logo on its bottom or on its packaging, you can be certain that it is perfectly compatible with your hob under normal operating conditions. To help you choose, a list of cookware is provided with this guide.

• WHICH COOKING ZONE SHOULD YOU USE BASED ON YOUR COOKWARE?

Cooking zone	Cookware to use
16 cm	10 18 cm
18 cm	12 22 cm
21 cm	18 24 cm
23 cm	12..... 26 cm
28 cm	12 32 cm



Tip

To check the suitability of your cookware:

Place the vessel on a cooking zone at power level 4.

If the display remains on, your cookware is compatible.

If the display flashes, your cookware cannot be used with induction cooking.

You can also use a magnet to test the cookware.

If a magnet "sticks" to the bottom of the cookware, it is compatible with induction.

• DESCRIPTION OF THE CONTROL PANEL

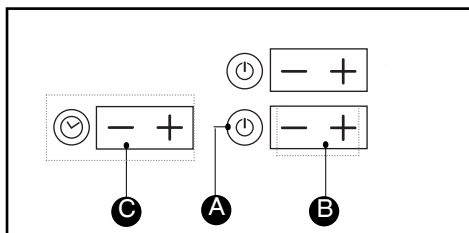

- A** Start/stop touch control.
- B** Power - + touch controls.
- C** Power - + touch controls.

• POWERING ON

Press the start/stop button for the cooking zone you want to use. A flashing 0 and a bip indicate that the cooking zone is on. You can then choose the desired power level.

If you do not select a power level, the cooking zone will automatically turn itself off.

• STOP

Press the start/stop button for the cooking zone used or the power "-" button until 0 is displayed.

• ADJUSTING THE POWER

Press the + power button, and a bip* will confirm that your settings from 1 to P (maximum power) are actually taken into account.

When it is switched on you can move directly to maximum power "P" by pressing the "-" button.



Tip

For simultaneous use, favour the use of cooking zones located on opposite sides of the hob.

On the same side, the use of a cooking zone at maximum power results in an automatic limitation of the other cooking zone on that side, which is indicated in the power level display.

• ADJUSTING THE TIMER

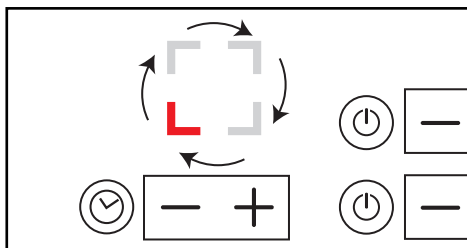

There is a timer for each cooking zone.

Use the ☺ button to select the cooking zone on which you would like to use the timer.

If you press this button several times, a rotating symbol will show which cooking zone the timer is being used for.

The timer may only be used for one cooking zone at a time.

To use the timer:

- turn on the cooking zone
- select the rotating symbol for this cooking zone.

The timer only operates if there is something on the cooking zone.

- adjust the timing by pressing "+" on the timer (or "-" adjusting from 99,98,97,...min).

As soon as you release the button, the power display will show the power of the cooking zone or a "t".

When you have finished cooking, the cooking zone turns itself off, the timer shows 0 and a **bip** sounds. Press any button to stop the bip.

- To change the timer settings, press the - or + buttons on the timer.

- To stop the timer, press the ☺ button.

- To use the timer on a different cooking zone, choose a new use by pressing the ☺ button several times.

When the previous timing stops, set your timing for the new cooking zone using the "+" or "-" buttons.

• **CHILD SAFETY” USE**



Your hob has a child safety device which locks the controls when the hob is not in use (when cleaning for example) or when it is being used for cooking (to maintain your settings). Due to safety reasons, only the “stop” control is always active. It authorises a heating zone to be switched off even when the hob is locked.

• **How do you lock your hob?**

Maintain pressure on the lock key until the led on top lights up and a beep confirms your maneuver.

• **Hob locked when in operation**

The display of cooking zones in operation alternately indicates power and the locking symbol .

When you press the **power** or **timer** controls for the zones in operation, the lock led lights up. It will switch off after a few seconds. Only the “stop” control remains on at all times.

For cooking zones that are not in operation, the  symbol and the led light up when you press the “**start/stop**” controls

This display will switch off after a few seconds.

• **The hob is locked when switched off**

The led above the lock key is switched off. Press this control briefly to switch on the led. The led displays when you press the **start / stop** key in any zone.

• **How do you unlock your hob?**

Press the lock control until the led switches off and a double beep confirms your maneuver.



Tip

Remember to unlock your hob before using it again (see chapter on “child safety use”).

• SAFETY DURING OPERATION

• *Residual heat*

After intensive use, the cooking zone that you have just used can remain hot for several minutes.

An "H" is displayed during this period.

Avoid touching the hot areas during this time.

• *Temperature limiter*

Each cooking zone is equipped with a safety sensor that constantly monitors the temperature of the bottom of the cookware. In the event that an empty vessel is left on a cooking zone that is on, this sensor automatically adjusts the power output of the hob, thereby avoiding any risk of damage to the cookware or the hob.

• *"Small Items" safety*

A small object (such as a fork, a spoon, a ring, etc.) left alone on the hob is not detected as a piece of cookware.

The display flashes and no heat is produced.



Warning

Several small objects together on a cooking zone may be detected as cookware.

If the display remains on: power may be supplied and the objects may be heated.

• *Protection against overflows*

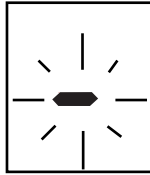

The hob may shut down (with the adjacent symbol in the display) automatically in any of these three situations:

- Overflow that spills onto the touch controls.
- Damp towel placed over the touch controls.
- Metallic object placed on the touch controls.

Clean the hob or remove the object, then begin cooking again.

• *Auto-Stop system*

If you forget to switch off a cooking zone, your hob has an "Auto-Stop system" safety function which automatically cuts off the power to the cooking zone, after a predefined period (between 1 and 10 hours depending on the power used).

If this safety system is used, the cutoff to the cooking zone is displayed as "AS" or "A" on the control panel and a "bip" sounds for about 2 minutes. Simply press any of the control buttons to stop this.

A double bip will confirm your action.

• **PROTECTING YOUR APPLIANCE**

Avoid hard shocks from cookware:
The vitroceramic glass worktop is very sturdy; however, it is not unbreakable.

Do not place any hot lids flat on your cooking hob. A suction effect may damage the vitroceramic surface.

Avoid dragging cookware across the surface, which may in the long-term result in the degradation of the decorative finish of the vitroceramic top.

Avoid placing cookware on the frame or cover (depending on the model).

Avoid using cookware with rough or bumpy bottoms: they can capture and transfer particles that may produce stains or scratches on your hob.

These defects that do not result in appliance malfunction or do not make it unsuitable for use are not covered by the warranty.

Do not store cleaning products or flammable products in the cabinet underneath your cooking hob.

Do not heat unopened canned goods; they may burst.

Of course, this precaution applies to all types of cooking.

Never use a sheet of aluminium for cooking. Never place items wrapped in aluminium foil or packaged in aluminium dishes on your cooking hob.

The aluminium will melt and permanently damage your cooking appliance.

Objects not intended for cooking should never be placed on the hob (risk of powering on, scratches, etc.).

Steam cleaning should never be used. The steam jet could damage your hob.

• **MAINTAINING YOUR APPLIANCE**

TYPE OF STAINS/SPOTS	USE	WHAT TO DO
Light.	Disinfectant sponges.	Thoroughly moisten the zone to be cleaned with hot water, then wipe off.
Accumulation of baked-on soil. Overflow of sugary preparations, melted plastic.	Disinfectant sponges. Scraper for glass.	Thoroughly moisten the zone to be cleaned with hot water. Use a scraper for glass to remove the large bits, follow with the rough side of a disinfectant sponge, and then wipe off.
Rings and hard water residue.	White spirit vinegar.	Apply warm white vinegar to the stain, let stand, then wipe with a soft cloth.
Shiny metallic streaks.		
Weekly maintenance.	Cleaning agent for vitroceramic glass.	Apply a cleaning agent for vitroceramic glass (preferable one with silicone for its protective properties) to the surface.



Cream



Special disinfectant sponge for delicate dishes



Powder





Scouring sponge



• During initial use

<i>YOU OBSERVE THAT:</i>	<i>POSSIBLE CAUSES:</i>	<i>WHAT SHOULD YOU DO:</i>
An indicator light appears.	Working normally.	Nothing.
Your installation blows a fuse.	The electrical hook-up of your hob is incorrect.	Verify the connections. See the "Hook-Up" section.
Only one side works.		
The hob produces an odour during the first cooking sessions.	New appliance.	Operate each cooking zone for 30 minutes with a saucepan full of water.

• When powering on

<i>YOU OBSERVE THAT:</i>	<i>POSSIBLE CAUSES:</i>	<i>WHAT SHOULD YOU DO:</i>
The hob is not working and the indicator lights on the control panel are not on.	The appliance is not receiving electricity. The electrical supply is defective or the hook-up is incorrect.	Inspect the electrical circuit breaker and fuses.
The table is not working and another message is displayed.	The electronic board is functioning poorly.	Call the After-Sales Service Department.
The hob does not function, the information   is displayed.	The hob is locked.	See chapter on using the child safety system.

• During operation

<i>YOU OBSERVE THAT:</i>	<i>POSSIBLE CAUSES:</i>	<i>WHAT SHOULD YOU DO:</i>
The hob stops working and it emits a beep approximately every 10 seconds and a  or "F7" is displayed.	There was an overflow or an object is in contact with the control panel.	Clean the hob or remove the object, then begin cooking again.
A series of small  or "F7" is displayed.	The electronic boards heated up.	See "Built-In" section.
After turning on a heating zone, the indicator lights on the control panel continue to flash.	The cookware used is not suitable for induction or is less than 12 cm in diameter (10 cm for the 16-cm cooking zone).	See section on cookware for induction.
The saucepans make noise during cooking. Your hob makes a clicking sound during cooking.	This is normal with some types of cookware. This is caused by the transfer of energy from the hob to the cookware.	Nothing. There is no risk, neither to your hob nor to your cookware.
The fan continues to function a few minutes after your hob is turned off.	Cooling of the electronic components. Working normally.	Nothing.



Warning

In the event that there is a break, crack or opening—even minor—in the vitroc ceramic glass, immediately disconnect your appliance to avoid the risk of electric shock. Contact the After-Sales Service Department.

• COOKING CHART

		FRY BRING TO A BOIL	COOK/BROWN RETURN TO BOILING BOILING LIGHT BROTHS		COOK/SIMMER			KEEP WARM	
		P 9 8	7	6	5	4	3	2	1
SOUPS	BROTHS					●			
	THICK SOUPS						●		
FISH	COURT BOUILLON			●					
	FROZEN FOODS				●				
SAUCE	THICK, FLOUR-BASED					●			
	BUTTER-BASED WITH EGGS (BEARNAISE, HOLLANDAISE) PREPARED SAUCES					●			●
		P 9 8	7	6	5	4	3	2	1
VEGETABLES	ENDIVES, SPINACH						●		
	DRIED BEANS						●		
	BOILED POTATOES				●				
	GOLDEN BROWN POTATOES				●				
	SAUTEED POTATOES				●				
	DEFROSTING VEGETABLES						●		
MEAT	MEAT, NOT TOO THICK		●						
	STEAKS, IN SKILLET			●					
	GRILLED MEATS (CAST IRON GRILL)		●						
FRYING	FROZEN FRENCH FRIES	●							
	FRESH FRENCH FRIES	●							
		P 9 8	7	6	5	4	3	2	1
MISCELLA-NEOUS	PRESSURE COOKER (ONCE IT STARTS WHISTLING)					●			
	COMPOTES				●				
	CRÊPES			●					
	CRÈME ANGLAISE		●						
	MELTED CHOCOLATE								●
	JAMS				●				
	MILK		●						
	EGGS, FRIED			●					
	PASTA			●					
	JARS OF BABY FOOD (DOUBLE BOILER)				●				
	MEAT STEW		●						
	SPANISH RICE						●		
	RICE PUDDING						●		