



SP911SS

Caple Spirit 90cm hood



Technical information



SP911SS

Caple Spirit 90cm hood

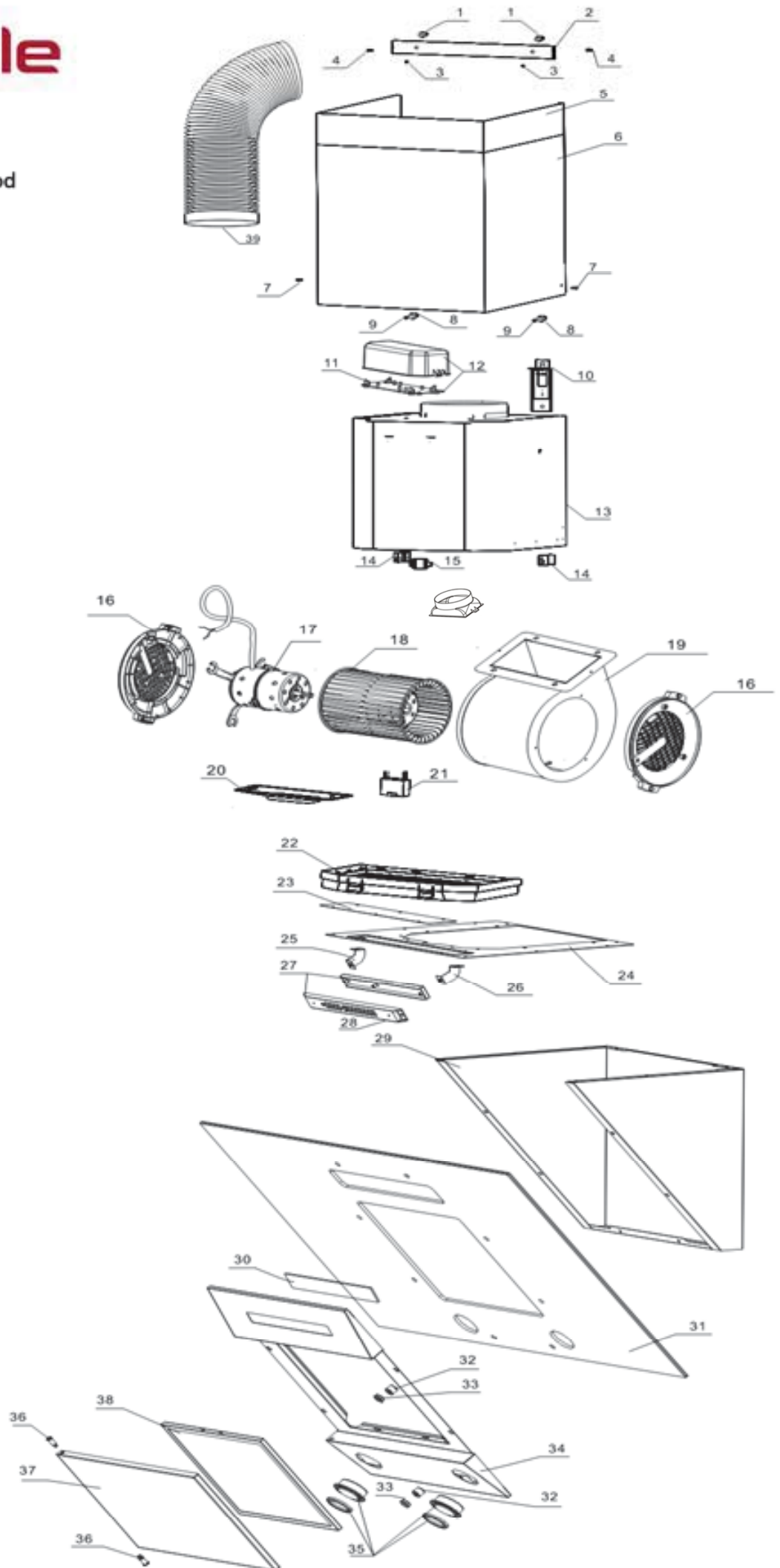



SP911SS - Caple Spirit Hood

Item	Part Code	Description	Qty
1	F-JL-6-30-A	6x30 plastic wall plug	2
2	B-ZCB6003A	Bracket for upper funnel	2
3	F-LD-4-16-SD	ST4x16 self tapping screw	2
4	F-LD-3--8-BC	M3x8 stainless steel countersunk screw	4
5	B-YCZ6021A-02-1	Upper funnel	1
6	B-YCZ6020A-01-1	Lower funnel	1
7	F-LD-4--8-BL	M4x8 B head mushroom screw	4
8	F-JL-10-45-A	10x40 inflatable colloidal particle	2
9	F-LD-5-50-SB	ST5*50 head mushroom screw	2
10	B-GG6000A	Leveling device assembly	2
11	D-DYB-YJ-K52.9S-QM2	power case board	1
12	D-DYH6001A	power case board compartment	1
13	B-FJX6007A	Air chamber	1
14	D-XJ6001A	Clip 1	2
15	D-XJ6002A	Clip 2	1
16	D-DQ6002A	Blower shell	1
17	D-DJ6015B	Motor 2 phase, 3 speed	1
18	D-FL6005A	Propellor	1
19	G-WK6004A	Metal blower box	1
20	D-YB5001A	Oil cup	1
21	D-DR-5-450	Capacitor 5 μ F	1
22	HXT6000B	coal filter	1
23	B-GB6009A	Canopy top panel	1
24	B-LJB6029A	connecting board	1
25	B-ZJ6084A	left control case mount	1
26	B-ZJ6084A	Right control case mount	1
27	D-KZH6005A	control case board compartment	1
28	D-KZB-YJ-K52.9S-QM	control case board	1
29	B-BB6004A	back panel	1
30	D-MB-K51.9S-BL	controller pcb plastic panel	1
31	D-BLZ6086A	Glass canopy	1
32	G-SLD6001A-DD-G	magnet brakect plastic washer	2
33	D-CX6002A	magnet brakect	2
34	B-MB6017A-2	stainless steel panel	1
35	D-LED6011A	LED lamps	2
36	D-TT6000A	bearing cap	2
37	B-GB6009A	Aluminium filter cap	1
38	D-LW6012A-1	Aluminium filter	1
39	D-DFG5000B	Wind pipe	1

D-ZHF6000A

Butterfly valve (spigot)