



C308SS

**Caple Double Multi Function Oven
Stainless Steel**



INSTRUCTION MANUAL

Thank you for buying your new CAPLE Double Oven. To ensure that you get the best results from your new CAPLE Double Oven, we strongly suggest that you read this instruction manual thoroughly before use. This manual contains installation advice, cleaning tips and a cooking guide, as well as other important facts about your CAPLE Double Oven. If treated with care, your CAPLE Double Oven should give you years of trouble-free cooking.

Safety Reminders	3
Electrical Requirements	4
Electrical Installation	5
How To Install Your Oven	6
How To Use Your Oven - Mod.: C 302	8
How To Use Your Oven - Control panel.....	9
How To Use Your Top Oven.....	10
How To Use Your Main Oven.....	11
Electronic clock/alarm (Main oven only)	12
How To Use Your Oven - Mod.: C 308	13
How To Use Your Oven - Control panel.....	14
How To Use Your Top Oven.....	15
How To Use Your Main Oven.....	17
Electronic programmer (Main oven only)	21
Cleaning and Maintenance	24
Helpful Advice	26
Cooking Guide	27
CAPLE service	28
Your Guarantee	28

The **CE** marking confirms that the appliance conforms to the following EU directives:

- safety requirements of EEC Directive "Low voltage" 73/23;
- protection requirements of EEC Directive "EMC" 89/336;
- requirements of EEC Directive 93/68.

**For Spare Parts, Technical Advice
or Product Service call the
CAPLE HELPLINE on 0870 241 1142**

(Answerphone outside office hours)

Safety Reminders

Instruction Book

This appliance should only be used for its intended purpose as described in these instructions.

Ensure that you fully understand these instructions before operating this appliance.

Space Requirements

Ensure that the specified ventilation space around the appliance is not obstructed.

Food Splashes

Always wipe clean the oven after use. Food splashes can carry on cooking next time and may become a fire hazard.

Hot Surfaces

It is important to remember that the surfaces of cooking appliances get hot during use and retain the heat for some time after switching off.

It is therefore advisable to keep small children away from the appliance.

The Grill and Top oven element

are exposed, so take great care when placing food in the oven or removing it. Use the grill pan handles or gloves.

DO NOT line the oven, grids, trays etc. with aluminium foil as this could adversely affect the heating elements and it could also damage the interior surfaces.

DO NOT place flammable materials in the oven.

Faults

Do not continue to use this appliance if it appears to be faulty.

After Use

Switch the oven controls off. Always switch off at the isolating switch before cleaning the appliance, or attempting any maintenance task, or when not in use for long periods (when on holiday).

CAPLE Service

To ensure the continued safe and efficient operation of this appliance, we recommend that any servicing or repairs are carried out only by an authorised CAPLE SERVICE ENGINEER.

Electrical Requirements

**WARNING!
ELECTRICITY CAN BE
EXTREMELY DANGEROUS.
THIS APPLIANCE MUST BE EARTH-
ED.**

This Installation should be carried out by a competent electrician in accordance with current I.E.E. Regulations.

This CAPLE product must be connected to an electricity supply at the voltage shown on the rating plate. Connection must be made via a double pole isolating switch with a contact separation of at least 3 mm.

Use supply cable, having a minimum conductor cross-sectional area of 2.5 mm² (3 cables).

Allow sufficient length in the supply cable(s) for removal of the appliance(s) for any subsequent servicing. Ensure that this extra cable is not trapped and is not in contact with the underside of any hob when fitting the appliance(s) in position.

As with all electrical appliances always switch off the electricity supply when not in use for long periods (when on holiday) and before attempting any maintenance task.

Fitting Into position

Your new CAPLE oven is designed to fit into a kitchen unit which is at least 555 mm deep.

Before proceeding with the installation, check that the oven will fit into the space intended for it, appropriate ventilation slots are provided as per installation instructions on page 6 and that all packing material has been removed.

IMPORTANT

Materials used to build the oven housing must be capable of withstanding temperatures of up to 100°C and the housing must be firmly fixed in position.

Before Use

Check that all accessories have been removed from the oven interior.

Set the temperature to maximum position using the temperature control knob.

Leave on for approximately 30 minutes. This will burn off any protective coating applied to the oven during manufacture.

The kitchen should be well ventilated during this time as there may be an odour given off.

When cool, wash the accessories and the oven with warm water and mild detergent.

Electrical Installation

This appliance must be connected to a double pole isolating switch (fig. 1) and to the terminal block in the oven (figs. 2 & 3) using the following guide:

- 1) The wire which is coloured brown must be connected to the terminal marked **L** (Live), or coloured Red.
- 2) The wire which is coloured blue must be connected to the terminal marked **N** (Neutral), or coloured Black.
- 3) The wire which is coloured green and yellow must be connected to the terminal marked **E** (Earth)  or coloured Green.

IMPORTANT: These connections must be carried out by a qualified electrical engineer.

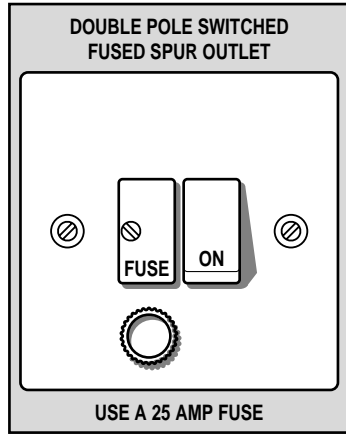

Fig. 1

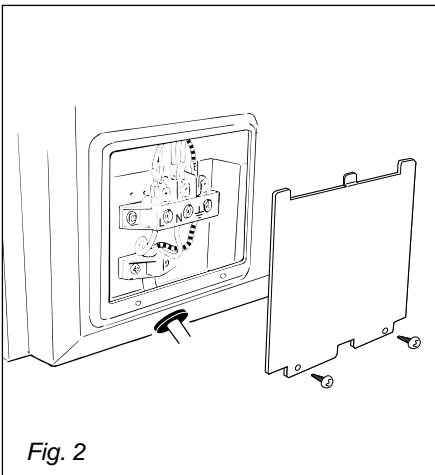

Fig. 2

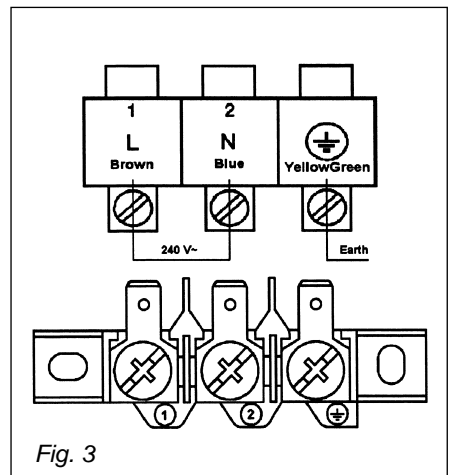

Fig. 3

How To Install Your Oven

You need the following housing area to fit your oven correctly.

Dimensions (mm)	Oven	Housing
Height	888	877
Width	594	560
Depth	560	555 min.

This appliance is type **X** installation.

The oven is designed to fit into a cabinet 600 mm width. The oven should be built into kitchen units (figs. 4a - 4b), but you must ensure that it is properly in the diagram the oven is ventilated by mean of the space in the top of the kitchen cabinet (see diagram).

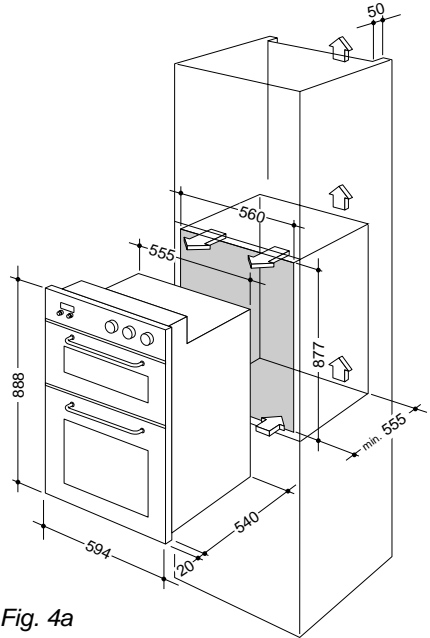

Fig. 4a

Failure to allow adequate ventilation for the appliance may result in over heating or damage to adjacent units.

Caple does not accept any responsibility for any damage caused due to non-compliance with these instructions.

To install the oven into a kitchen unit (figs. 4a - 4b) first ensure that the oven housing is firmly secured to the wall and/or adjacent fittings.

Lift the oven carefully into position on the shelf, taking care NOT to lift it by the door handle.

If you lower the oven door, you will see four screw holes, two on each side of the oven.

The oven should then be secured to the housing by fitting screws into these holes.

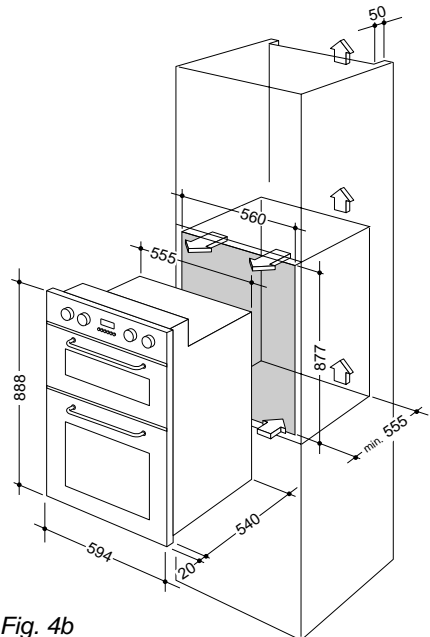

Fig. 4b

How To Install Your Oven

Using the top and the main oven for the first time

You are advised to carry out the following operations:

- Clean the inside of the two ovens with a cloth soaked in water and neutral detergent and dry thoroughly.
- Hang up the wire racks on the oven walls (Figure 5 and 6).
- Slide in, on the guides, the shelf and the tray etc. (Figure 7).
- To eliminate traces of grease from the heating elements, switch on the ovens to the maximum temperature in this ways:

For 60 minutes in the **Oven** position, for 30 minutes in the **Fan Oven** position (main oven only), and for another 15 minutes in the **Grill** position.

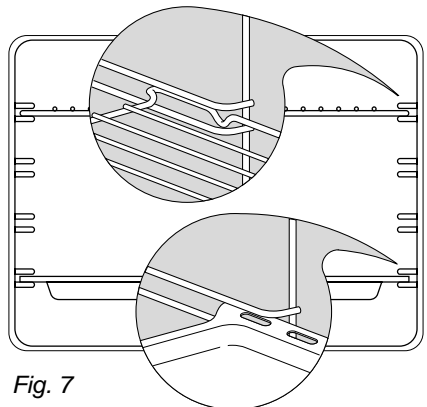
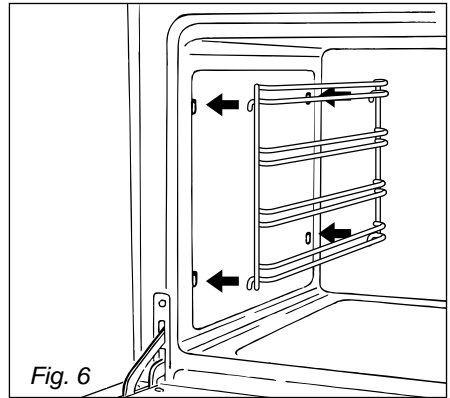
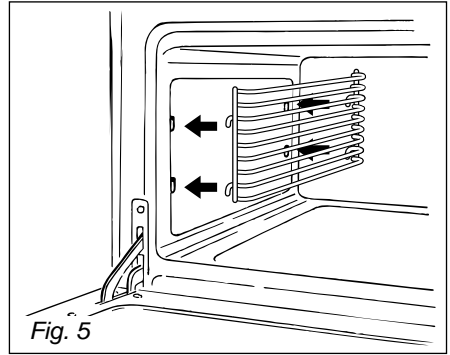

How To Use Your Oven

Cooking in a Conventional Top Oven

The oven has two heating elements, one on the base and one on the roof of the cooker.

Hot air rises, so the top of the oven is always the hottest.

The temperature in the middle of the oven is maintained at the temperature set by the control knob, and is slightly hotter above and cooler below.

In a conventional oven, dishes requiring different temperatures can be cooked in the oven at the same time - e.g. roast beef and Yorkshire pudding.

Always pre-heat a conventional oven before use.

The oven indicator light will go out when the required temperature is reached.

Do not open the oven door during cooking unless absolutely necessary.

IMPORTANT: Drip trays, baking trays etc. must not be left on the base of the oven as this could damage the appliance.

Cooking in a Main Fan Oven

The fan is situated on the back wall of the oven.

The heating element encircles the fan, and the fan forces this heat into the oven, through the sidewalls, creating a more even temperature than a conventional oven.

The moving hot air surrounds the food and penetrates it more quickly than in a conventional oven.

The oven can be filled with foods all requiring the same cooking temperature. Subtract 10 minutes per hour for every dish requiring a conventional cooking time of more than one hour, and to reduce the heat by 10-20°C; the hotter the oven, the more heat can be reduced.

Generally, there is no necessary to pre-heat a fan oven.

However, pre-heating for 5 minutes ensure the best results.

When the fan is turned on and the temperature control set is at 0°C, the oven can be used for defrosting food.

This is ideal for gelatin based dishes and softening ice-cream - a microwave oven is much too strong for these dishes.

Proving yeast based dishes is also speeded up this way.

If the oven door has been opened, the fan oven quickly regains its temperature once the door is closed.

How To Use Your Oven - Control panel

Model: C 302

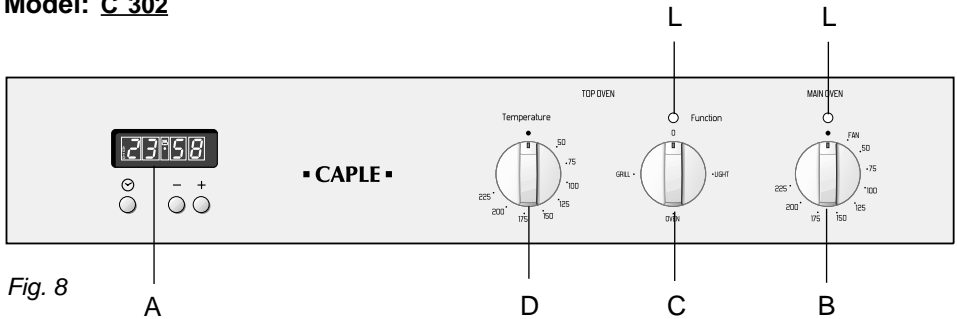

Fig. 8

Control panel

- A. Electronic clock/alarm (Main oven only)
- B. Main oven selector
- C. Top oven function selector
- D. Top oven temperature selector
- L. Temperature light

How To Use Your Top Oven

TOP OVEN

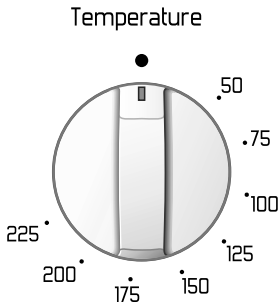

Fig. 9

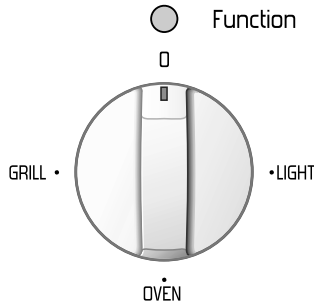

Fig. 10

Function Selector (fig. 10)

Cook or grill by turning the knob until the indicator on it is in line with the function required.

LIGHT The oven light is switched on.

OVEN Use in conjunction with the temperature selector **C**. It is advisable to pre-heat the oven until the set temperature has been reached ie: when the indicator light above the temperature selector goes off.

GRILL Grill with the door **closed**. Set the function selector **C** to the grill position and the temperature selector **D** to the **max. 225°C** for 15 minutes, then to the **max. 175°C**. The temperature can be varied depending on the food being cooked. Before using the grill, pre-heat for about five minutes. Position the grill pan on the highest shelf position and check continually as the food could easily burn.

Note: it is recommended that you do not grill for longer than 30 minutes at any one time.

Remember to keep children away from the appliance when you use the grill or oven, since these parts become very hot.

Temperature Selector (fig. 9)

The light above this dial will illuminate when the oven is switched on and turns off when the oven reaches the correct temperature.

The light will cycle on and off during cooking in line with the oven temperature.

Cleaning your oven

The inside of the oven can be easily cleaned with a wet cloth and oven cleaner.

As a safety measure, before you start cleaning the oven, make sure the electrical supply is switched off.

You should clean the oven when it is cold.

Do not leave acid or alkaline residues (lemon juice, vinegar, salt, tomato, etc) on the enamelled surfaces.

Avoid abrasive cleaning products on the painted parts.

How To Use Your Main Oven

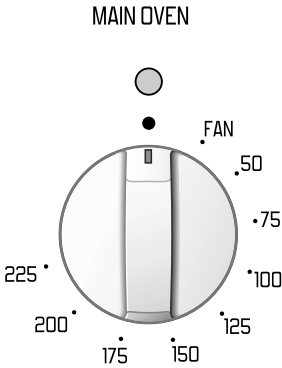

Fig. 11

Function/Temperature Selector (fig. 11)

Cook by turning the knob until the indicator on it is in line with the function/function temperature required.

- FAN** The fan switches on. This function can be used for defrosting food.
- 50-225** These show the approximate temperature in °C. It is advisable to pre-heat the oven for at least 5 minutes. The set temperature has been reached when the indicator light above the function/temperature selector goes off. The light will cycle on and off during cooking as the oven maintains the selected temperature.

Grease Filter

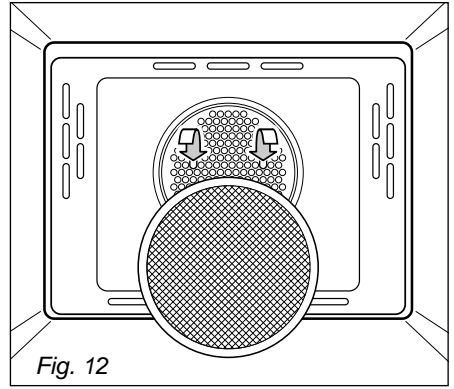

Fig. 12

A special screen is provided at the back of the fan oven to catch grease particles, mainly when meat is being roasted. When baking pastry etc, the filter should be removed.

Always clean the filter after cooking as any solid residues on it might adversely affect the oven performance.

The inside of the oven can be easily cleaned with a wet cloth and oven cleaner.

As a safety measure, before you start cleaning the oven, make sure the electrical supply is switched off.

You should clean the oven when it is cold.

Do not leave acid or alkaline residues (lemon juice, vinegar, salt, tomato, etc) on the enamelled surfaces.



Avoid abrasive cleaning products on the painted parts.

Electronic Clock/Alarm (Main oven only)

The electronic alarm is a device which groups the functions of a 24 hours clock with illuminated display and 99 minutes alarm.

A - Electronic clock

Upon immediate connection of the cooker or after a mains failure, three zeros will flash on the programmer panel.

To set the clock it is necessary to push the  button and then, within 7 seconds, the  or  button until you have set the correct time.

The clock will show zero after a mains failure.

Attention: When the programmer display shows three flashing zeros the oven cannot be switched on.

The oven can be switched on when the symbol  is shown in the display.

Setting the frequency of the alarm sound

The selection from 3 possibilities of sound can be made by pressing the  button.

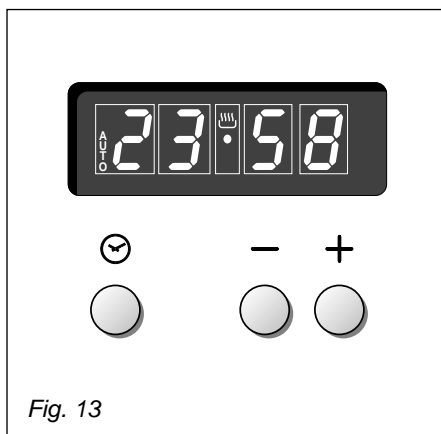





Fig. 13



Cooking with automatic swith-off (Main oven only)

The aim of this function is to automatically stop the cooking after a pre programmed time, for a maximum period of 99 minutes.

To set the cooking time, push the  or  button until you obtain the desired time in the display.



The symbol **AUTO** will be shown in the display. Then you adjust the oven thermostat knob according to the required temperature. The oven will immediately start to operate and will work for the pre programmed time. The display shows the count down. Clock time can be displayed by pressing the  button. Once the time has elapsed, the oven will switch off automatically, the symbol **AUTO** will go off and an intermittent buzzer, lasting 7 minutes, will start; this can be stopped by pressing the  button.

Important: Before the buzzer is stopped switch off the oven manually.

To cancel the cooking program at any time press the  and  buttons together and release the  button first.

Electronic alarm

The programmer can be used as an alarm only for a maximum period of 99 minutes.

To set the alarm, push the  or  button until you obtain the desired time in the display. Once the time has elapsed, an intermittent buzzer, lasting 7 minutes, will start; this can be stopped by pressing the  button.

Attention: If the main oven is switched on when the buzzer starts, it will be automatically switched off. For it to operate further you have to stop the buzzer by pressing the  button.

How To Use Your Oven

Top Oven general features

This is a conventional oven with 2 cooking positions, thermostatically controlled, obtained by 3 heating elements (top, bottom and grill).

Top Oven operating principles

Heating and cooking in the CONVENTIONAL oven are obtained in two following ways:

- a. by normal convection
The heat is produced by the upper and lower heating elements.
- b. by radiation
The heat is irradiated by the infra red grill element.

Main Oven general features

This is a MULTI-FUNCTION oven. As its name indicates, this is an oven that presents particular features from an operational point of view. In fact, it is possible to set 7 different programs to satisfy every cooking need. The 7 positions, thermostatically controlled, are obtained by 4 heating elements (top, bottom, grill and circular).

Main Oven operating principles

Heating and cooking in the MULTI-FUNCTION oven are obtained in the following ways:

- a. by normal convection
The heat is produced by the upper and lower heating elements.
- b. by forced convection
A fan sucks in the air contained in the oven muffle, which sends it through the circular heating element and then sends it back through the muffle. Before the hot air is sucked back again by the fan to repeat the described cycle, it envelops the food in the oven, provoking a complete and rapid cooking.

It is possible to cook several dishes simultaneously.
- c. by semi-forced convection
The heat produced by the upper and lower heating elements is distributed throughout the oven by the fan.
- d. by radiation
The heat is irradiated by the infra red grill element.
- e. by radiation and ventilation
The irradiated heat from the infra red grill element is distributed throughout the oven by the fan.
- f. by ventilation
The food is defrosted by using the fan only function without heat.

How To Use Your Oven - Control panel

Model: C 308

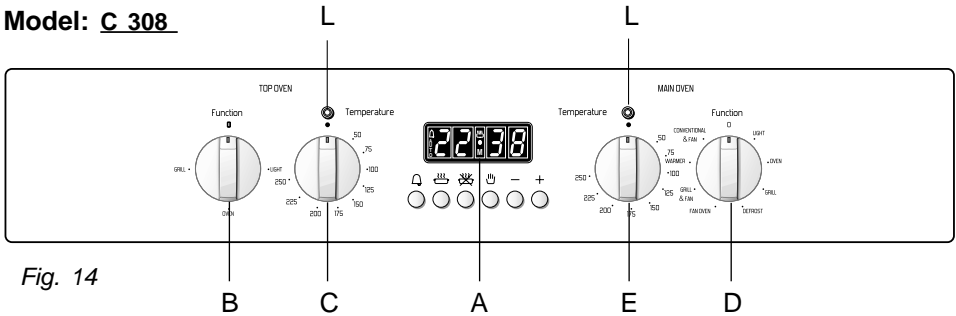

Fig. 14

Control panel

- A. Digital electronic programmer (Main oven only)
- B. Function selector (Top oven)
- C. Thermostat (Top oven)
- D. Function selector (Main oven)
- E. Thermostat (Main oven)
- L. Temperature light

How To Use Your Top Oven

TOP OVEN

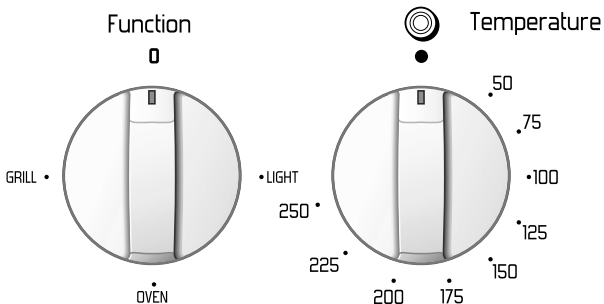

Fig. 15

Fig. 16

Function selector knob (fig. 15)

Rotate the knob clockwise to set the oven for one of the following functions.

LIGHT

By setting the knob to this position, only the oven light comes on (15 W). It remains on in all the cooking modes.

OVEN

The upper and lower heating elements come on. The heat is dispersed by natural convection and the temperature must be set to between 50° and 250°C via the thermostat knob.

The oven must be preheated before cooking.

Recommended for:

Food that requires the same degree of cooking both inside and out, for example roasts, spare pork ribs, meringues etc.

Thermostat knob (fig. 16)

This only sets the cooking temperature and does not switch the oven on. Rotate clockwise until the required temperature is reached (from 50 to 250°C)

How To Use Your Top Oven

GRILL

The infrared electrical resistance comes on. The heat is dispersed by radiation. Use with the thermostat knob set to **225°C** for 15 minutes, then to **175°C** and the oven door closed.

For cooking hints, see the below chapter “**GRILLING and AU GRATIN**”.

Always grill with the oven door closed.

Recommended for:

Intense grilling, browning, cooking au gratin and toasting etc.

It is recommended that you do not grill for longer than 30 minutes at any one time.

Attention: the oven door becomes very hot during operation. Keep children away.

Cooking in a conventional top oven

- The oven has two heating elements, one on the base and one on the roof of the cooker. Hot air rises, so the top of the oven is always the hottest. The temperature in the middle of the oven is maintained at the temperature set by the control knob, and is slightly hotter above and cooler below.
- In a conventional oven, dishes requiring different temperatures can be cooked in the oven at the same time - e.g. roast beef and Yorkshire pudding.
- Always pre-heat a conventional oven before use. The oven indicator light will go out when the required temperature is reached. Do not open the oven door during cooking unless absolutely necessary.
- **IMPORTANT:** Drip trays, baking trays etc. must not be left on the base of the oven as this could damage the appliance.

Grilling and “au gratin”

Leave to warm up for approximately 5 minutes with the door **closed**.

Place the food inside positioning the rack as near as possible to the grill. Insert the drip pan under the rack to collect the cooking juices.

It is recommended that you do not grill for longer than 30 minutes at any one time.

Remember to keep children away from the appliance when you use the grill or oven, since these parts become very hot.

How To Use Your Main Oven

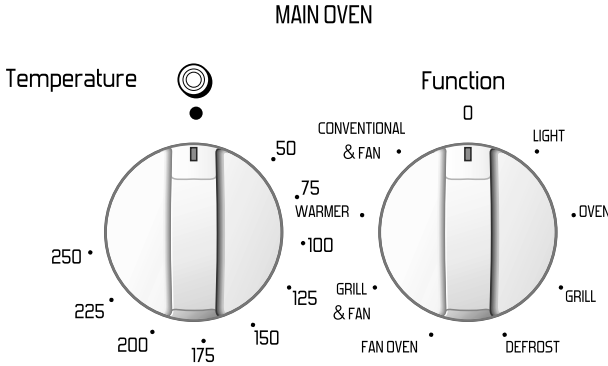

Fig. 17

Fig. 18

Thermostat knob (fig. 17)

This only sets the cooking temperature and does not switch the oven on. Rotate clockwise until the required temperature is reached (from 50 to 250°C)

Function selector knob (fig. 18)

Rotate the knob clockwise to set the oven for one of the following functions.

LIGHT

By setting the knob to this position, only the oven light comes on (15 W). It remains on in all the cooking modes.

OVEN

The upper and lower heating elements come on. The heat is dispersed by natural convection and the temperature must be set to between 50° and 250°C via the thermostat knob. The oven must be preheated before cooking.

Recommended for:

Food that requires the same degree of cooking both inside and out, for example roasts, spare pork ribs, meringues etc.

How To Use Your Main Oven

GRILL

The infrared electrical resistance comes on. The heat is dispersed by radiation. Use with the thermostat knob set to **225°C** for 15 minutes, then to **175°C** and the oven door closed.

For cooking hints, see the chapter “**Use of the grill**”.

Always grill with the oven door closed.

Recommended for:

Intense grilling, browning, cooking au gratin and toasting etc.

It is recommended that you do not grill for longer than 30 minutes at any one time.

Remember to keep children away from the appliance when you use the grill or oven, since these parts become very hot.

DEFROST

Only the oven fan comes on. Use with the thermostat knob set to “●” - other positions have no effect. The food is thawed by ventilation without heating.

Recommended for:

Quick thawing of frozen foods; one kg requires approximately 1 hour.

Thawing times vary according to the quantity and type of food to be thawed.

FAN OVEN

The circular resistance and fan come on. The heat is dispersed by forced convection and the temperature can be regulated to between 50° and 250°C via the thermostat knob. The oven does not require preheating.

Recommended for:

Food which has to be well-cooked outside and soft or rosy inside, for example lasagne, lamb, roast beef, whole fish etc.

GRILL & FAN

The infrared grill and the fan come on. The heat is dispersed mainly by radiation and the fan then distributes it all over the oven.

Use with the door closed. The temperature can be regulated via the thermostat knob to between 50° and 175° max. The oven must be preheated for approximately 5 minutes. For cooking hints, see the chapter “**GRILLING AND COOKING AU GRATIN.**”

Recommended for:

Grilling where quick browning on the outside is required to keep the juices in. For example: veal steaks, chops, hamburgers etc.

It is recommended that you do not grill for longer than 30 minutes at any one time.

Remember to keep children away from the appliance when you use the grill or oven, since these parts become very hot.

WARMER

The upper resistance, the circular resistance and the fan come on.

The heat is dispersed by forced convection with greater intensity in the upper part.

The temperature can be set to between 50° and 140°C via the thermostat knob.

Recommended for:

Keeping food warm after any type of cooking. Slow heating of cooked food.

How To Use Your Main Oven

CONVENTIONAL & FAN

The upper and lower heating elements come on and the fan.

The heat coming from above and below is dispersed by convection with ventilation.

The temperature can be set to between 50° and 250°C via the thermostat knob.

Recommended for:

Voluminous dishes and large quantities which require the same degree of cooking both inside and out, for example rolled roasts, turkey, roast legs, cakes etc.

Main oven Cooking advice

Sterilization

Sterilization of foods to be conserved, in full and hermetically sealed jars, is done in the following way:

- a. Set the switch to position **Fan Oven**.
- b. Set the thermostat knob to position 185 °C and preheat the oven.
- c. Fill the dripping pan with hot water.
- d. Set the jars onto the dripping pan making sure they do not touch each other and the door and set the thermostat knob to position 135 °C.
When sterilization has begun, that is, when the contents of the jars start to bubble, turn off the oven and let cool.

Regeneration

Set the switch to position **Conventional & Fan** and the thermostat knob to position 150° C.

Bread becomes fragrant again if wet with a few drops of water and put into the oven for about 10 minutes at the highest temperature.

Simultaneous cooking of different foods

The MULTI-FUNCTION oven set on position **Conventional & Fan** consents a simultaneous heterogeneous cooking of different foods.

Different foods such as fish, cake and meat can be cooked together without mixing the smells and flavors together. This is possible since the fats and vapors are oxidized while passing through the electrical element and therefore are not deposited onto the foods.

The only precaution to follow are:

- The cooking temperatures of the different foods must be as close to as possible, with a maximum difference of 20° - 25 °C.
- The introduction of the different dishes in the oven must be done at different times in relation to the cooking times of each one.

The time and energy saved with this type of cooking is obvious.

How To Use Your Main Oven

Grilling and “au gratin”

Grilling may be done without the roasting jack on position **Grill & Fan** of the switch, because the hot air completely envelops the food that is to be cooked. Set the thermostat to position 175 °C and after having preheated the oven, simply place the food on the rack.

Close the door and let the oven operate with the thermostat on position 175 °C, until grilling is done.

Adding a few dabs of butter before the end of the cooking time gives the golden “au gratin” effect.

It is recommended that you do not grill for longer than 30 minutes at any one time.

Attention: the oven door becomes very hot during operation. Keep children away.

Roasting

To obtain classical roasting, it is necessary to remember:

- that it is advisable to maintain a temperature between 180 and 200 °C.
- that the cooking time depends on the quantity and the type of foods.

Use of the grill

Preheat the oven for about 5 minutes.

Introduce the food to be cooked, positioning the rack as close to the grill as possible.

The drip pan should be placed under the rack to catch the cooking juices and fats.

Grilling with the oven door closed.

Do not grill for longer than 30 minutes at any one time.

Caution: the oven door becomes very hot during operation. Keep children well out of reach.

Grease Filter

A special screen is provided at the back of the fan oven to catch grease particles, mainly when meat is being roasted. When baking pastry etc, the filter should be removed.

Always clean the filter after cooking as any solid residues on it might adversely affect the oven performance.

The inside of the oven can be easily cleaned with a wet cloth and oven cleaner.

As a safety measure, before you start cleaning the oven, make sure the electrical supply is switched off.

You should clean the oven when it is cold.

Do not leave acid or alkaline residues (lemon juice, vinegar, salt, tomato, etc) on the enamelled surfaces.

Avoid abrasive cleaning products on the painted parts.

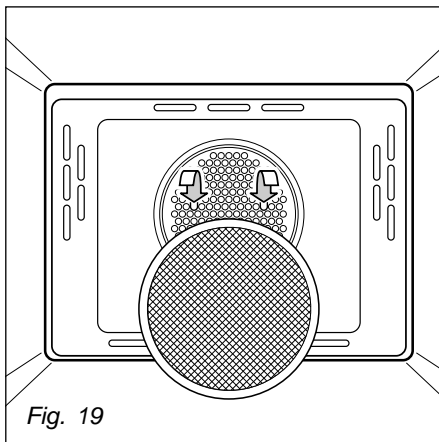

Electronic Programmer (Main oven only)

Autotimer

The electronic programmer is a device which groups together the following functions:

- 24 hours clock with illuminated display
- Timer (up to 23 hours and 59 minutes)
- Program for automatic oven cooking
- Program for semi-automatic oven cooking.

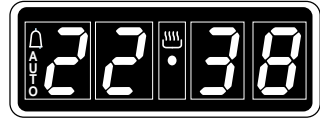

Description of the buttons:

- Timer
- Cooking time
- End of cooking time
- Manual position and cancellation of programmed cooking
- Advancement of the numbers of all programs
- Turning back of the numbers of all programs and changing the frequency of the audible signal.

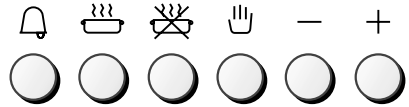

Fig. 20

Description of the lighted symbols:

AUTO - *flashing* - Programmer in automatic position but not programmed
AUTO - *always lighted* - Programmer in automatic position with program inserted.

- Automatic cooking taking place
- Timer in operation
- and **AUTO** - *flashing* - Program error.
(The time of day lies between the calculated cooking start and end time).

NOTE: Select a function using the respective button and, in 5 seconds, set the required time with the / buttons ("one-hand" operation).

A power-cut makes the clock go to zero and cancels the set programs.

Electronic Clock

The programmer is equipped with an electronic clock with lighted numbers which indicates hours and minutes.

Upon immediate connection of the oven or after a power-cut, three zeros will flash on the programmer panel.



To set the hour it is necessary to push the button and then the or button until you have set the exact hour.

In another way push simultaneously the two buttons and at the same time push the or button.

NOTE: The hour setting after programming delete any program.

Electronic Programmer (Main oven only)

Normal Cooking without the use of the Programmer

To manually use the oven, that is, without the aid of the programmer, it is necessary to cancel the flashing **AUTO** by pushing the button  (**AUTO** will be switched off and the symbol  will go on).





Attention: If the **AUTO** is steady lighted (which means a cooking program has already been inserted), by pushing the button  you will cancel the program and revert to manual operation.



If the oven is switched on, remember you must switch off manually.

Electronic Timer

The timer program consists only of a buzzer which may be set for a maximum period of 23 hours and 59 minutes.

If the **AUTO** is flashing push the  button.

To set the time, push the  button and the  or  until you obtain the desired time in the panel (fig. 14). Having finished the setting, the clock hour will appear on the panel and the  symbol will be lighted.

The countdown will start immediately and may be seen at any moment on the panel by simply pressing the button . At the end of the time, the  symbol will be switched off and an intermittent buzzer will sound; this can be stopped by pressing one of any of the buttons.

Setting the frequency of the Audible Signal







The selection from 3 possibilities of sound can be made by pressing the  button. The last setting remains on.

Setting the Automatic Oven Cooking

To cook food automatically in the oven, it is necessary to:

1. Set the length of the cooking time
2. Set the end of the cooking time
3. Set the temperature and the oven cooking program.

These operations are done in the following way:

1. Set the length of the cooking time by pushing the  button and the  button to advance, or  to go back if you have passed the desired time. The **AUTO** and the  symbol will be on.
2. Set the end of the cooking time by pressing the  button (the cooking time already added to the clock time will appear), and the  button; if you pass the desired time you may get back by pushing the  button.

After this setting, the  symbol will go off. If after this setting, the **AUTO** flashes on the panel and a buzzer sounds, it means there was an error in the programming,

Electronic Programmer (Main oven only)

that is that the cooking cycle has been superimposed on the clock. In this case, modify the end of cooking time or the cooking time itself by following again the above mentioned instructions.

3. Set the temperature and the cooking program by using the switch and thermostat knobs of the oven (see specific chapters).

Now the oven is programmed and everything will work automatically, that is the oven will turn on at the right moment and end the cooking at the selected time.

During cooking, the  symbol remains on.

By pushing the  button you can see the time that remains until the end of cooking.

The cooking program may be cancelled at any moment by pushing .



At the end of the cooking time the oven will turn off automatically, the  symbol will turn off, **AUTO** will flash and a buzzer will sound, which can be turned off by pushing any of the buttons.

Turn the switch and thermostat knobs to zero and put the programmer onto “manual” by pressing the  button.



Attention: A power-cut makes the clock go to zero and cancels the set programs. After a power-cut, three zeros will flash on the panel.

Setting the Semi-Automatic Oven Cooking

This is used to switch automatically off the oven after the desired cooking time has elapsed. To effect the semi-automatic cooking there are two ways:

1. Set the length of the cooking time by pushing the  button and the  button to advance, or  to go backwards if you have passed the desired time.





or

2. Set the end of the cooking time by pushing the  button and the  button to advance, or  to go backwards if you have passed the desired time.

AUTO and the  symbol will be on.

Then set the temperature and the cooking program using the oven switch and thermostat knobs (see specific chapters).

The oven is switched on and it will be switched off automatically at the end of the desired time.

During cooking, the  symbol remains on and by pressing the button  you can see the time that remains till the end of the cooking. **The cooking program can be cancelled at any moment by pushing the  button.** At the end of the cooking, the oven and the  symbol will turn off, the **AUTO** will flash and a buzzer will sound; that can be stopped by pushing any of the buttons. Turn the switch and thermostat knobs to zero and set the programmer onto “manual” by pressing the  button.

Cleaning and Maintenance

Before cleaning the double oven switch it off and wait for it to cool down.

Important:

Before any operation of cleaning and maintenance disconnect the appliance from the electrical network.

General

Installation, and any demonstration, information or adjustments are not included in the warranty.

We recommend that the installation is carried out by qualified personnel.

After use allow the oven to cool and whilst the oven is still “warm” it should be wiped with a damp cloth using warm soapy water. With regular cleaning the oven will remain in good condition.

Enamel Parts

In order to maintain the condition of the enamel parts, clean and wipe frequently with hot soapy water. Any obstinate marks can be removed using a paste or cream cleaner or a well moistened soap impregnated steel wool pad. Rub gently so as not to damage the surface.

Never use abrasive powders.

Never permit vinegar, coffee, milk, salt water or tomato juice to remain in contact with the enamel parts as they may stain or discolour the surface.

If any cleaners such as a spray or a stick are used on enamel they must have the VEDC (Vitreous Enamel Development Council) seal of approval and the manufacturers instructions must be followed.

Stainless steel surfaces (model: C 308)

CAUTION

The stainless steel surfaces used in this oven are protected with a Special Lacquer to reduce finger-print marks.

To avoid damaging this lacquer, do not clean the stainless steel with abrasive cleaners or abrasive cloths or scouring pads.

ONLY SOAP/WARM WATER MUST BE USED TO CLEAN THE STAINLESS STEEL SURFACES.

REPLACING the oven light

To replace the interior oven lamp, unscrew the glass guard and make sure that the new lamp has identical specifications, i.e. 15 Watts, 300°Centigrade.

Be sure to switch off the electrical supply.

Cleaning and Maintenance

Removal of the inner glass door panel

The inner glass door panel can easily be removed for cleaning by unscrewing the two screws (figure 21).

During re-assembly, ensure that the inner glass is correctly aligned and do not over tighten the screws.

ATTENTION

The appliance gets very hot, mainly around the cooking areas. It is very important that children are not left alone in the kitchen when you are cooking.

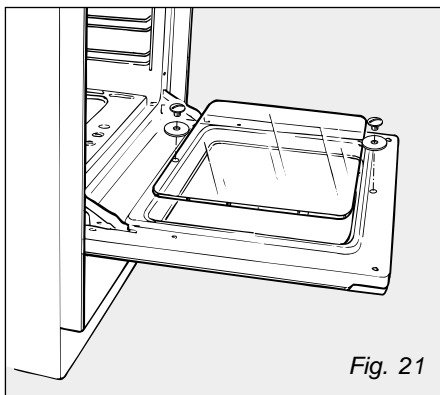

Fig. 21

Do not use a steam cleaner because the moisture can get into the appliance thus make it unsafe.

Helpful Advice

Trouble shooting

Problem

Food too brown but not cooked.

Remedy

Turn down the oven temperature slightly and cook a little longer

Problem

Food cooked but not brown enough.

Remedy

Increase temperature.

Problem

Food baking unevenly.

Remedy

1. The temperature may be slightly high turn it down
2. Position the food in the centre of the shelves rather than towards the sides of the oven.
3. Rotate the food a half turn in the oven.
4. Try pre-heating the oven for 5-15 minutes prior to baking.

Always remove cooked items as soon as they are ready and continue cooking the under-cooked items until they are completely finished.

Changing the Oven Cavity Light Bulb.

If the oven light falls:

1. Turn off the oven by switching the oven selector to 0, switch off at the cooker point.

2. When the oven is cool, reach back and upwards inside the oven, the bulb is in the top left corner.
3. Unscrew the light glass cover, replace the bulb with a new one of the same specification and screw the cover back until it is hand tight.

NOTE: Oven bulb replacement is not covered by your guarantee.

Other bulbs cannot be changed by yourself and should be replaced by an authorised CAPLE Service Engineer.

Bulbs other than the oven bulb are covered by the guarantee.

IMPORTANT: Ovens get hot. Keep children away from this appliance at all times.

If Your Oven Does Not Work

Before calling a CAPLE service engineer run through the following checklist.

1. The oven is connected to the power supply and that the fuse is intact.
2. Make sure the timer control is set to the manual position, and that the oven has not been set inadvertently for an automatic or timed programme (main oven only).

If you are in any doubt about carrying out these checks, call the **CAPLE Helpline on 0870 241 1142.**

A charge will be made if the appliance is found to be in working order, or if it has not been installed in accordance with these instructions, or if it has been used incorrectly.

Recommended cooking temperature

Food	°C	°F	Gas Mark	Shelf Position*	Cooking Time (approx)
CAKES					
Victoria sandwich	190	375	5	2 or 3	20-25 mins
Small cakes/buns	190	375	5	1 and 2	15-20 mins
Maidera cake	180	350	4	2 or 3	20 mins
Fruit cake	170	325	3	3	1 ³ / ₄ hours
Rich fruit cake	150	300	2	3 or 4	2 ¹ / ₂ hours
Scones	225	425	8-9	2	8-10 mins
PASTRY					
Puff	225	425	8-9	2	10-20 mins
Short crust	200	400	6	2	20-30 mins
Plate tarts	200-210	400-410	6	1 or 2	30-35 mins
Quiches and flans	200-210	400-410	6	1 or 2	40-45 mins
YEAST					
Bread loaf	225	425	7-8	2	35-55 mins
Bread rolls	220	425	7	1 or 2	15-20 mins
Pizza dough	230	450	8	2	20 mins
ROAST MEAT					
Beef – Medium	190	375	5	2 or 3	20 mins/lb + 20 mins
Lamb	190	375	5	2 or 3	25-30 mins/b + 25 mins
Pork	190-200	375-400	5-7	2 or 3	30 mins/lb + 30 mins
Veal	190	375	5	2 or 3	30 mins/b + 30 mins
Chicken	190	375	5	2 or 3	30 mins/b + 30 mins
Turkey up to 10lb	180	350	4	2 or 3	18-20 mins/b + 20 mins
Stews/casseroles	150-170	300-325	2-3	2 or 3	1 ¹ / ₂ 2 hours

N.B. For fan ovens reduce the temperature by 10-20°C. For any dish taking one hour or over to cook, reduce the cooking time by 10 minutes per hour.

* Shelf positions have been counted from the top of the oven to the base. A fan oven creates more even temperature throughout, therefore the shelf positions are not as critical.

CAPLE “Built-in” Service

Should you require service at any time, please contact the **Caple Helpline on 0870 241 1142.**

Caple have a nationwide service network of engineers who will respond quickly to your call.

Always replace spare parts with genuine **Caple** spares. These are available from authorised **Caple Service Centres** or by mail order from our **National Service Stores, simply telephone 0870 241 1142.**

When ordering parts always quote the model number and serial number of your appliance.

YOUR GUARANTEE

CAPLE guarantees all parts of this product for one year from the date of purchase. During that time, should it become necessary CAPLE engineers will replace or repair all defective parts free of charge, except for parts subject to fair wear and tear, such as lightbulbs.

Parts and the engineers labour costs are chargeable after the first 12 months.

To qualify for benefits under the guarantee, you must be able to provide proof of date of purchase and the appliance must have been supplied, installed and used for domestic purposes only in accordance with CAPLE instructions.

Consequential losses and accidental damage to the product are not covered by the guarantee.

This guarantee does not affect your statutory or common law rights.

CAPLE cannot be responsible for the results of using this appliance for any other purposes other than those described in these instructions.