



C240SS

Caple Premium Pyro Oven Stainless Steel



INSTRUCTION MANUAL

Dear Customer,

Thank you for having purchased and given your preference to our product.

The safety precautions and recommendations within this booklet are for your own safety and that of others. They will also provide a means by which to make full use of the features offered by your appliance.

Please preserve this booklet carefully. It may be useful in future, either to yourself or to others in the event that doubts should arise relating to its operation.

This appliance must be used only for the task it has explicitly been designed for, that is for cooking food-stuffs. Any other form of usage is to be considered as inappropriate and therefore dangerous.

The manufacturer declines all responsibility in the event of damage caused by improper, incorrect or illogical use of the appliance.

IMPORTANT PRECAUTIONS AND RECOMMENDATIONS

- After having unpacked the appliance, check to ensure that it is not damaged.
If you have any doubts, do not use it and contact the store from where you purchased it.
- Packing materials (i.e. plastic bags, polystyrene foam, nails, packing straps, etc.) should not be left around within easy reach of children, as these may cause serious injuries.
- Do not attempt to modify the technical characteristics of the appliance as it may become dangerous to use.
- Never cover the oven walls with aluminium foil. Do not put baking sheets or the drip tray on the bottom of the oven.
- Do not carry out cleaning or maintenance operations on the appliance without having previously disconnected it from the electric power supply.
- If you should decide not to use this appliance any longer (or decide to substitute an older model), before disposing of it, it is recommended that it be made inoperative in an appropriate manner in accordance to health and environmental protection regulations, ensuring in particular that all potentially hazardous parts be made harmless, especially in relation to children who could play with old appliances.

IMPORTANT PRECAUTIONS AND RECOMMENDATIONS FOR USE OF ELECTRICAL APPLIANCES

Use of any electrical appliance implies the necessity to follow a series of fundamental rules. In particular:

- Never touch the appliance with wet hands or feet;
- do not operate the appliance barefooted;
- do not allow children or disabled people to use the appliance without your supervision.

The manufacturer cannot be held responsible for any damages caused by improper, incorrect or unreasonable use of the appliance.

DECLARATION OF CE CONFORMITY

- This oven has been designed to be used only for cooking. Any other use (such as heating a room) is improper and dangerous.
- This oven has been designed, constructed, and marketed in compliance with:
 - safety requirements of EEC Directive “Low voltage” 73/23
 - safety requirements of EEC Directive “EMC” 89/336;
 - requirements of EEC Directive 93/68.



MULTIFUNCTION PYROLYTIC OVENS

Multifunction oven with “fan grill cooking” function

Fig. 1.1

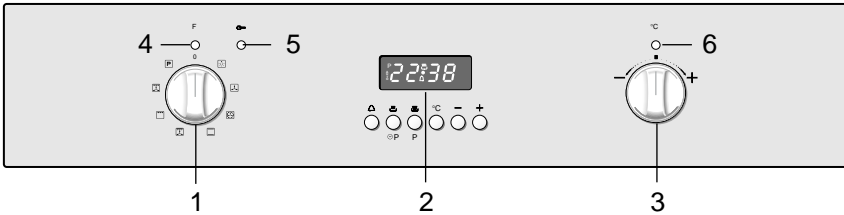

Multifunction oven with “fan grill cooking” function

Fig. 1.2

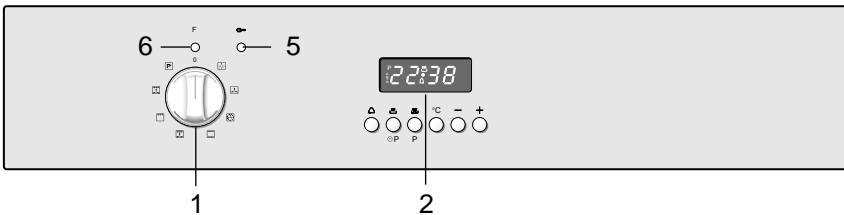

Multifunction oven with “grill cooking with turnspit” function

Fig. 1.3

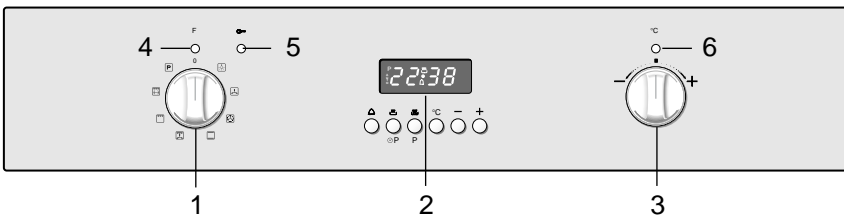

Multifunction oven with “grill cooking with turnspit” function

Fig. 1.4

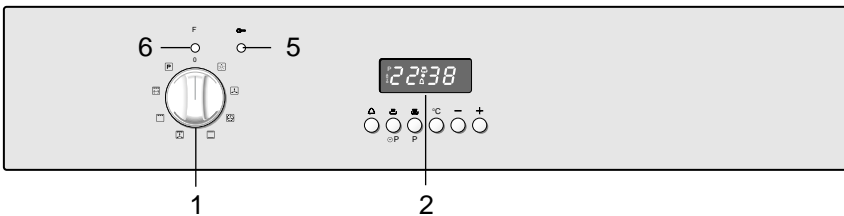

PLURIFUNCTION PYROLYTIC OVENS

Plurifunction oven with “fan grill cooking” function

Fig. 1.5

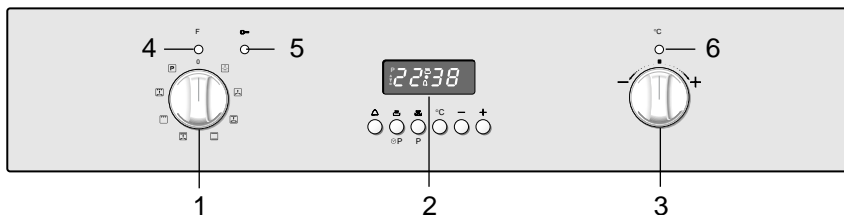

Plurifunction oven with “fan grill cooking” function

Fig. 1.6

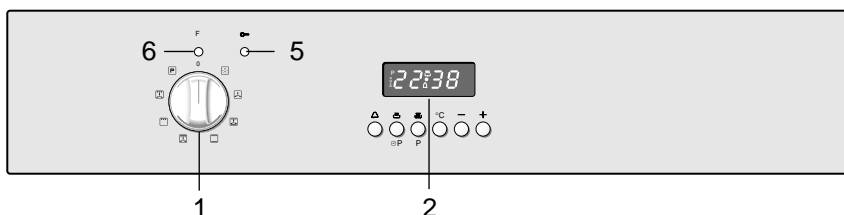

Plurifunction oven with “grill cooking with turnspit” function

Fig. 1.7

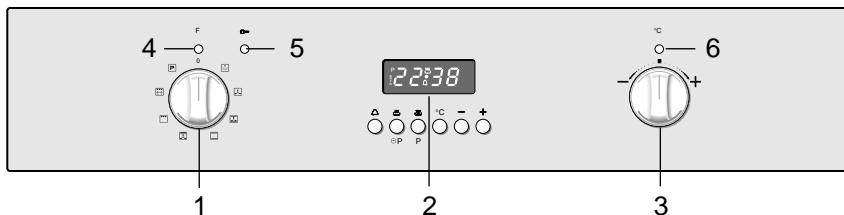

Plurifunction oven with “grill cooking with turnspit” function

Fig. 1.8

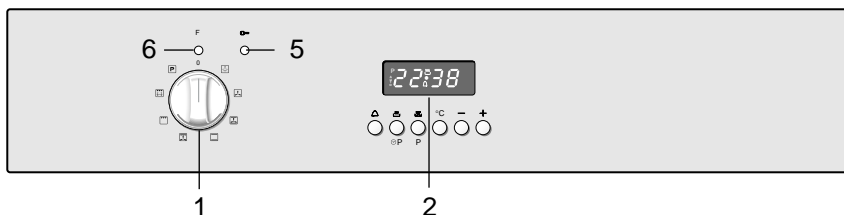

DESCRIPTION OF COMMANDS

1. Function selector knob
2. Electronic programmer
3. Temperature knob (potentiometer)
4. Line pilot light
5. Door locked pilot light
6. Temperature pilot light

TECHNICAL FEATURES

This oven has special operating features.

5 different functions can be used to satisfy all cooking needs; it also has a pyrolytic function which can clean the oven cavity at high temperature, a defrost function and an oven light function.

The functions are managed by an electronic programmer which keeps the temperature set constant by means of a probe inside the oven cavity.

The oven has the following heating elements:

- Lower heating element (double) 500 + 1300 W
- Upper heating element 1000 W
- Grill heating element 2000 W
- Circular heating element 2200 W (only in multifunction pyrolytic ovens)

WARNING:

The door is hot, use the handle.

During use the appliance becomes hot. Care should be taken to avoid touching heating elements inside the oven.

USING THE OVEN FOR THE FIRST TIME

- Put in the shelves and trays.
- Switch the oven on empty (on a cooking function – **NOT PYROLYSIS**) at maximum power for about 2 hours to remove traces of grease and smells from the components.
- When the oven has cooled down and unplugging it, clean the inside of the oven with a cloth soaked in water and neutral detergent and dry it perfectly.

NOTES ON OVEN WORKING

A cooling fan starts automatically when the temperature inside the oven cavity is higher than 100°C and stops when the temperature drops below 100°C. For the pyrolytic function only, it starts immediately the pyrolytic cycle starts.

The purpose of this fan is to reduce the temperature inside/outside the appliance.

OPERATING PRINCIPLES

Heating and cooking in the multifunction pyrolytic oven takes place as follows:

- **by normal convection**

The heat is produced by the upper and lower heating elements.

- **by forced convection (only in multifunction pyrolytic ovens)**

A fan sucks in the air contained in the oven, which circulates it through the circular heating element and then forced back into the oven by the fan. Before the hot air is sucked back again by the fan to repeat the described cycle, it envelops the food in the oven, provoking a complete and rapid cooking. It is possible to cook several dishes simultaneously.

- **by semi-forced convection (only in plurifunction pyrolytic ovens)**

The heat produced by the upper and lower heating elements is distributed throughout the oven by the fan.

- **by radiation**

The heat is radiated by the infra red grill element.

- **by radiation and fan (only in multifunction or plurifunction pyrolytic ovens without turnspit)**

The radiated heat from the infra red grill element is distributed throughout the oven by the fan.

- **by double radiation and fan**

The fan distributes the heat radiated by the grill heating element and the upper heating element in the oven.

- **by ventilation**

The food is defrosted by using the fan only function without heat.

- **by pyrolysis**

The heat produced by the heating elements cleans the internal oven cavity removing all residue of grease.

THIS IS NOT A COOKING FUNCTION

**Attention: the oven door becomes very hot during operation.
Keep children away.**

Note: The first time the oven is used or after a black-out the programmer must be started by pressing keys 2 and 3 simultaneously. See the chapter on the use of the electronic programmer.



SELECTING THE FUNCTIONS (fig. 2.1)

The cooking function is selected by turning the function selector knob and matching the mark with the symbol printed on the print.

Important: In all cooking functions the oven must always be used with the **DOOR CLOSED**.

If the door stays open “door” appears on the programmer display and after five minutes an audible warning sounds for 30 seconds and “door” flashes.



To silence the audible warning press any programmer pushbutton.

NOTE: The heating elements work even with the door open and this signal just indicates that energy is being wasted.

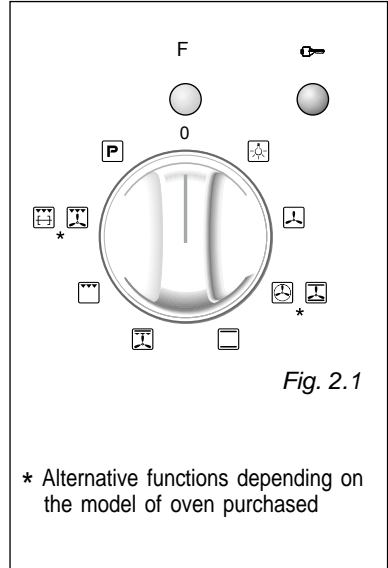

Fig. 2.1



OVEN LIGHTING

On turning the knob to this position only the oven lamp lights up. The lamp is always on in all the cooking functions (not for the pyrolysis).



DEFROSTING FROZEN FOODS (this is not a cooking function)

Only the fan and the oven lamp switch on. Defrosting takes place by fan, without heating. The electronic programmer shows **DEF**



Recommended for:

To rapidly defrost frozen foods; 1 kilogram requires about one hour. The defrosting times vary according to the quantity and type of foods to be defrosted.



HOT AIR COOKING (* only in some models)

The circular heating element and the fan switch on. The heat is diffused by forced convection and the temperature can be set between 50 and 250°C.

On selecting this function the electronic programmer starts cooking with a pre-heating time set at 180°C. To vary the temperature see the “Setting the cooking” chapter.

Recommended for:

For foods that must be well done on the outside and tender or rare on the inside, i. e. lasagna, lamb, roast beef, whole fish, etc.



CONVECTION COOKING WITH FAN (* only in some models)

The upper and lower heating elements and the fan switch on. The heat from the top and the bottom is diffused by fan convection. The temperature can be set between 50 and 250°C.

On selecting this function the electronic programmer starts cooking with a pre-heating time set at 180°C. To vary the temperature see the “Setting the cooking” chapter.

Recommended for:

For foods of large volume and quantity which require the same internal and external degree of cooking; for ex: rolled roasts, turkey, legs, cakes, etc.



TRADITIONAL CONVECTION COOKING

The upper and lower heating elements switch on.

The heat is diffused by natural convection and the temperature must be set between 50 and 250°C.

On selecting this function the electronic programmer starts cooking with a pre-heating time set at 200°C. To vary the temperature see the “Setting the cooking” chapter.

Recommended for:

For foods which require the same cooking temperature both internally and externally, i. e. roasts, spare ribs, meringue, etc.



FAN COOKING WITH DOUBLE GRILL

The infrared ray grill, the upper heating element and the fan switch on. The heat is mainly diffused by radiation and the fan distributes it in the whole oven. The temperature can be set between 50 and 250°C.

On selecting this function the electronic programmer starts cooking with a pre-heating time set at 240°C. To vary the temperature see the “Setting the cooking” chapter.

Recommended for:

Meats which are to be cooked at a high temperature but which must remain tender. Fish remains more tender; turn it once during cooking.



GRILLING

The infrared heating element switches on.

The heat is diffused by radiation. The temperature can be set between 50 and 250°C. On selecting this function the electronic programmer starts cooking with a pre-heating time set at 210°C. To vary the temperature see the “Setting the cooking” chapter.

Recommended for:

Intense grilling action for cooking with the broiler; browning, crisping, “au gratin”, toasting, etc.

For correct use see the “Grilling” chapter.



VENTILATED GRILL COOKING (* only in some models)

The infrared heating element and the fan switch on. The heat is mainly diffused by radiation and the fan distributes it in the whole oven.

The temperature can be set between 50 and 250°C.

On selecting this function the electronic programmer starts cooking with a pre-heating time set at 220°C. To vary the temperature see the “Setting the cooking” chapter.

Recommended for:

For grill cooking when a fast outside browning is necessary to keep the juices in, i. e. veal steak, steak, hamburger, etc.

For correct use see the “Fan grilling” chapter.



GRILLING WITH TURNSPIT (* only in some models)

The infrared grill switches on and the turnspit motor starts. The heat is diffused by radiation. The temperature can be set between 50 and 250°C.

On selecting this function the electronic programmer starts cooking with a pre-heating time set at 220°C. To vary the temperature see the “Setting the cooking” chapter.

Recommended for:

Cooking on the spit.

For correct use see the “Grilling with turnspit” chapter.



PYROLYSIS FUNCTION

IMPORTANT NOTES:

This is not a cooking function but is only used to clean the oven.

Before starting the pyrolytic cycle:

- Take all the accessories out of the oven (drip tray and shelves). If the oven has an anti-grease filter unhook and remove it, as described on page 30.
- Clean any traces of liquid which have overflowed.
- Close the oven door and make sure that it is closed properly.

If there are cracks or flaws on the oven door glass (inside/outside) or if the gaskets are ruined or worn or if the door does not close perfectly, unplug the appliance and contact the After-Sales Service Centre.

GENERAL INFORMATION

- In this function the residual cooking greases on the inside walls of the oven cavity are pulverised by the high temperature. The fumes produced during this process are filtered by a special catalyst in the upper part of the appliance.
- Smells and fumes produced during pyrolysis are not a cause of alarm. Adequate ventilation should however be provided in the room where the oven is installed, e.g. by opening a window.
- Do not wait for the oven to be very greasy before performing this cleaning. It should not be performed after every cooking, either, but only when the level of dirt justifies it (on average 1 – 2 times a month depending on oven use).
- For safety reasons (high temperature of the oven cavity), when the pyrolysis starts the oven is automatically locked by an electronic device (on the control panel the pilot light with key symbol lights up). The door can no longer be opened and is only unlocked at the end of the cleaning cycle or, stopping the cycle, when the oven cavity has cooled to a temperature lower than 300°C.
- When the pyrolytic function starts an internal fan starts automatically to cool the oven walls. It only stops at the end of the cycle, when the oven cavity temperature has dropped below 100°C.
- The procedures for starting, stopping and completing the pyrolysis cycle and dealing with any problems are described in the following chapters:
 - “How to start the pyrolysis cycle”
 - “Problems in starting and during the pyrolysis cycle”
 - “How to stop the pyrolysis cycle”
 - “What to do when the pyrolysis cycle has finished”
 - “Abnormal situations and/or operating problems”
- **Caution: during the pyrolytic cycle the accessible parts may become hot. Keep children away.**

SETTING THE COOKING (ONLY FOR THE COOKING FUNCTIONS)

Models where the programmer sets the temperature

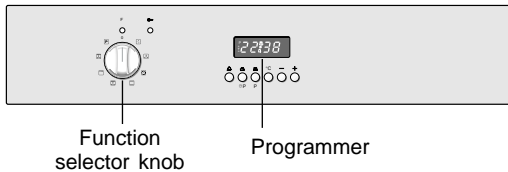
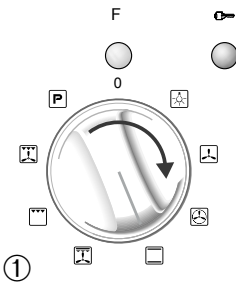

Fig. 2.2

The temperature set is shown on the electronic programmer display and can be varied, with 5°C intervals, by means of the programmer keys. During the cooking the oven temperature is measured by a sensor inside the cavity and is shown on the programmer display.



1. SELECTING THE COOKING FUNCTION

Turn the selector knob to the cooking function required

The pre-set temperature appears on the programmer display. °C flashes on the display for 3 seconds. The heating elements start cooking immediately.

2. SETTING THE COOKING TEMPERATURE

The temperature can be changed when °C is flashing on the display

2a. If °C is not flashing press key 4 of the programmer.

2b. Press key 6 to increase the temperature or key 5 to reduce it.

The maximum temperature which can be set is 250°C while the minimum temperature is 50°C.

Note: When °C becomes steady the value shown on the display indicates the oven cavity temperature.

Caution: If a temperature below the minimum value (50°C) is set the system switches off automatically and **OFF** appears.

In this case repeat the procedure from point 2.

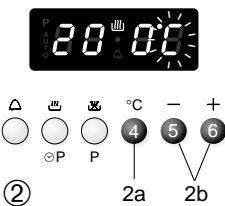

③

3. SWITCHING OFF

Turn the selector knob to position 0 (oven OFF). The programmer display shows the time.

SETTING THE COOKING (ONLY FOR THE COOKING FUNCTIONS)

Models with temperature knob (potentiometer)

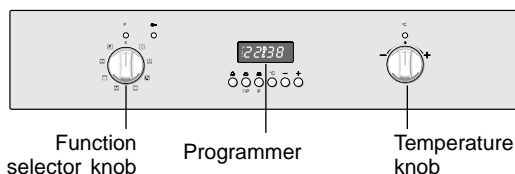
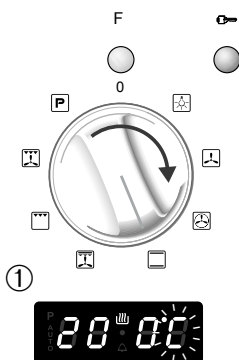

Fig. 2.3

NOTE: The temperature knob (potentiometer) turns to right and left only to symbols + and -. Forcing the turning could irreparably damage the temperature knob.



The temperature set is shown on the electronic programmer display and can be varied, with 5°C intervals, by turning the potentiometer knob.

During the cooking the oven temperature is measured by a sensor inside the cavity and is shown on the programmer display.

1. SELECTING THE COOKING FUNCTION

Turn the selector knob to the cooking function required

The pre-set temperature appears on the programmer display. °C flashes on the display for 3 seconds. The heating elements start cooking immediately.

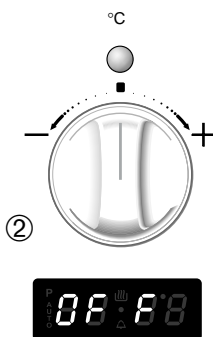

2. SETTING THE COOKING TEMPERATURE

Turn the potentiometer knob clockwise to increase the temperature or anticlockwise to reduce it.

The maximum temperature which can be set is 250°C while the minimum temperature is 50°C.

Note: When °C becomes steady the value shown on the display indicates the oven cavity temperature.

Caution: If a temperature below the minimum value (50°C) is set the system switches off automatically and **OFF** appears.

In this case repeat the procedure from point 2.

The temperature can also be set by means of the programmer keypad operating as in point 2 of the previous page.



3. SWITCHING OFF

Turn the selector knob to position 0 (oven OFF).

The programmer display shows the time.

HOW TO START THE PYROLYSIS CYCLE

Important: the pyrolysis cycle must only be performed with the oven empty; so, before starting the cycle take all the accessories (shelves, drip tray, baking tray and anti-grease filter) out of the oven cavity and dry any traces of overflowed liquid.

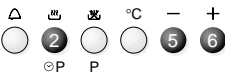
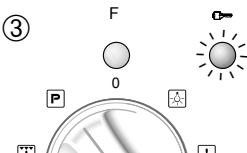
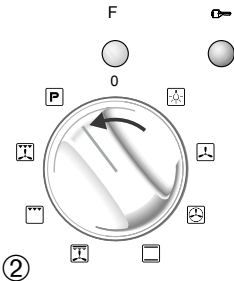

④



⑤

Do not use any degreasing products (e.g. degreasing sprays, detergents, etc.).

- 1. Close the oven door** (if it is open or not closed properly the pyrolysis cycle will not start).
- 2. Turn the oven selector knob to the pyrolysis position (P);** **P0•00** appears on the electronic programmer display with the letter **P** flashing.
- 3. Press pushbutton 3 on the programmer** to start the cycle.
This combined confirmation operation offers greater safety when there are children; in fact turning the knob to the pyrolysis function has no effect if key 3 of the programmer is not then pressed.
 - **P1•30** (pyrolysis time, 1 hour and 30 minutes) appears and the door is locked;
 - On the control panel the pilot light with the key lights up to indicate that the door is locked.
- 4. To increase the pyrolysis cycle time (max 3 hours)** press key 2 of the programmer then key 6. To go backwards to the minimum of 1 hour and 30 minutes press key 2 then key 5.
 - During the setting **AUTO** flashes and **P** disappears.
- 5. The pyrolysis cycle starts immediately and is completed in the programmed time.**
 - Throughout the pyrolysis cycle the programmer displays the time (hours and minutes) remaining until the cycle is finished.

VERY IMPORTANT:

The pyrolysis only starts with the oven door closed. If the door is open or not closed properly the oven CANNOT perform the pyrolysis; electronic safety devices prevent the pyrolysis from starting.

PROBLEMS ON STARTING AND DURING THE PYROLYSIS CYCLE



1. Steady *door*

The function selector has been turned to the pyrolysis position with the oven door open or not perfectly closed. Or the door has been opened before the cycle has been started with confirmation from key 3

What to do:

Close the door and repeat the operations to start the cycle.



- If after 5 minutes the door has not been closed **door flashes and an audible signal sounds for 30"**.

What to do:

Close the door, press any programmer key to silence the audible signal and repeat the operations to start the cycle.



2. *door* with **AUTO** flashing

The oven door has been opened after the pyrolysis cycle has started. The pyrolysis cycle is zeroed.

What to do:

1. Close the door. **P0•00** appears on the electronic programmer display with the letter **P** and **AUTO** flashing.

2. Turn the function selector to **0** and repeat the operations to start the cycle.

- If after 5 minutes the door has not been closed **door flashes and an audible signal sounds for 30"**.

What to do:

Close the door, press any programmer key to silence the audible signal and repeat the operations to start the cycle..



3. **F0.00** with **AUTO** flashing

The pyrolysis cycle has been stopped and then started again when it was quite a way through. The message is displayed after about 10 minutes and the pyrolysis cycle is zeroed.

What to do:

1. Put the switch to **0**.
2. Wait for at least 15 minutes.
3. Repeat the operations to start the Pyrolysis cycle.
4. If after several attempts the message continues contact the After-Sales Service Centre.

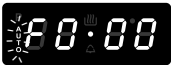

Caution: It is advisable not to stop the pyrolysis cycle and then start it again when it is quite a way through.

HOW TO STOP THE PYROLYSIS CYCLE

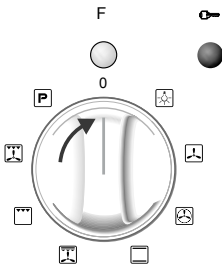

①



1a

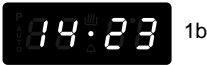

1b

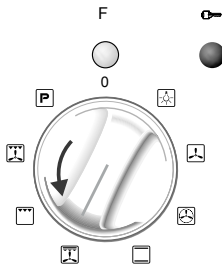

②



2a



2b



3d



3d

1. Turn the function selector to **0** (oven OFF)

- **If the oven cavity temperature is higher than 300°C**

1a. **do•Lo** (door locked) appears steadily on the programmer display.

1b. When the oven cavity temperature drops below 300°C:
 - the time appears on the programmer display again
 - the key pilot light goes out
 - the door unlocks

- **If the oven cavity temperature is lower than 300°C**

1c. The time appears on the programmer display

1d. After a technical time:
 - the key pilot light goes out
 - the door unlocks

ACCIDENTAL INTERRUPTION OF THE PYROLYSIS CYCLE

2. The function selector has been turned to any cooking function

- **If the oven cavity temperature is higher than 300°C**

2a. **do•Lo** (door locked) appears steadily on the programmer display.

2b. When the oven cavity temperature drops below 300°C:
 - **P0•00** appears with **P** flashing
 - the key pilot light goes out
 - the door unlocks

3c. To reset normal conditions turn the function selector to **0** (oven OFF). The time appears on the programmer display.

- **If the oven cavity temperature is lower than 300°C**

3d. The time appears on the programmer display, or the oven cavity temperature (**caution**: in this case the heating elements are working).

3e. After a technical time:
 - the key pilot light goes out
 - - the door unlocks

3f. To reset normal conditions turn the function selector to **0** (oven OFF). The time appears on the programmer display.

WHAT TO DO WHEN THE PYROLYSIS CYCLE HAS FINISHED



①

1. P0.00 with AUTO flashing.

Wait for the oven to cool down and the door to unlock.

The pyrolytic cycle has finished. **P0.00** will remain until the door is unlocked.

The door remains locked until the cavity temperature has dropped below 300°C.

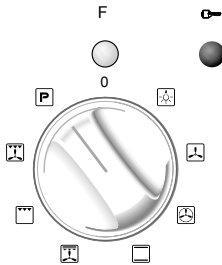

②

2. The light with the key symbol goes out (when the temperature has dropped below 300°C). AUTO and the letter P flash.

The door is unlocked and can be opened.



3. Turn the function selector knob to 0 (oven OFF).

The time appears on the programmer display.

4. Wait for the oven to cool down completely.

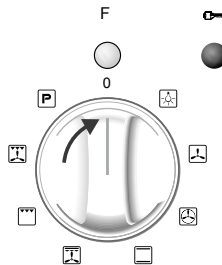

③

5. Remove the pulverised dirt.

Open the oven door and remove the residue of pulverised dirt inside the oven with a damp cloth.



Before switching the oven on again in any function wait for the appliance to cool down completely.

ABNORMAL SITUATIONS AND/OR OPERATION PROBLEMS

during cooking or the pyrolysis cycle.

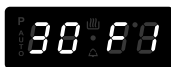
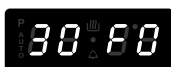

1. 30 F0 or 30 F1 appear during the cooking or pyrolysis cycle

Oven temperature sensor broken or not working properly. The cooling fan stays on and if the pyrolysis cycle is in progress the door remains locked.

What to do:

1. Turn the oven function selector to **0** (oven OFF). A 30 minute countdown will start. If the selector is turned and then returned to **0** the count will start again from 30.
2. Wait for the countdown to finish. The fan switches off and the door, if locked, unlocks.
3. Disconnect the oven from the mains and contact the After-Sales Service Centre because the oven can no longer be used.

Caution: If the function selector is not turned to **0** (oven OFF), the cooling fan will continue to work and the oven door, if locked, remains locked.



2. do.Lo appears during the pyrolysis cycle

2a. There has been a black-out

The oven door is locked. The programmer is zeroed and the Pyrolysis cycle cancelled.

What to do:

1. Turn the oven function selector to **0** (oven OFF).
2. Wait for the oven cavity to cool down. When the temperature has dropped **12.00** will flash on the display
3. Start again and set the programmer time
4. Start the pyrolysis cycle again.

2b. The oven function selector has been moved from the Pyrolysis function to a cooking function.

The Pyrolysis cycle is cancelled.





What to do:



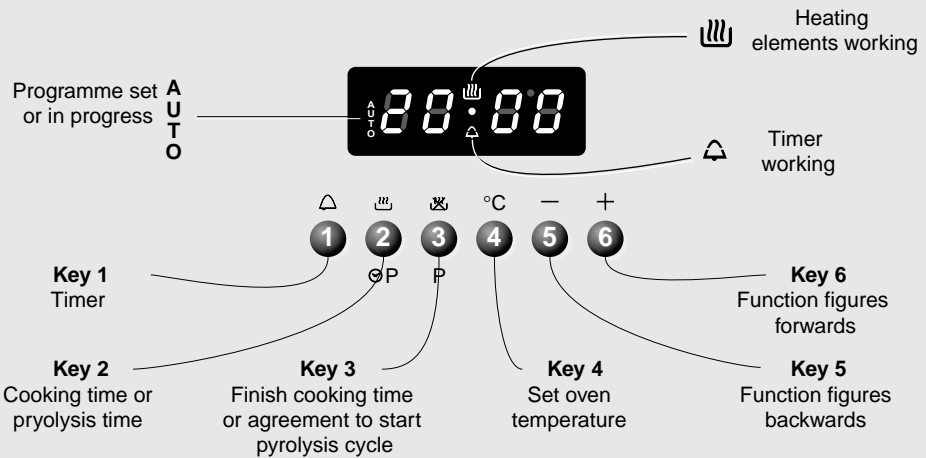



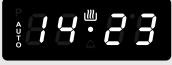

1. Wait for the door to unlock. This happens automatically when the temperature inside the oven has dropped below 300°C; **P0.00** will appear with **P** flashing.
2. Turn the function selector to **0** (oven OFF),
- 3 Repeat the operations to start the pyrolysis cycle.



Pyrolytic oven – Quick guide









Quick guide to be removed and used as a reminder after reading the instruction booklet carefully.

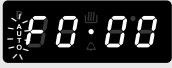

PROGRAMMER MESSAGE	MESSAGE MEANING	WHAT TO DO
	There has been a power cut or it is the first time the oven has been switched on	Set the time by pressing first keys 2 and 3 together, then keys 5 or 6.
 variable	Time	To set the time press keys 2 and 3 together, then keys 5 or 6.
 variable	Time with bell symbol ON. Timer counting backwards.	To display the timer count press pushbutton 1. To cancel the timer press pushbutton 1 then the key – until 00.00 appears.
 variable	Time with AUTO ON. Cooking programme set. The cooking has not yet started; the oven is OFF.	To display the end of cooking time press key 3; to display the cooking time press key 2. To cancel the programme turn the function selector knob to 0 .
 variable	Time with AUTO and cooking symbol ON. Cooking programme in progress. The oven is ON.	To display the end of cooking time press key 3; to display the cooking time press key 2. To cancel the programme turn the function selector knob to 0 .

PROGRAMMER MESSAGE	MESSAGE MEANING	WHAT TO DO	
 <p>variable</p>	Cooking time set or oven temperature measured by the internal sensor.	To change the cooking temperature press key 4 of the programmer, then keys 5 or 6.	
	A temperature below 50°C has been set. The oven has switched off.	Press key 4 of the programmer, then keys 5 or 6.	
	The audible signal has switched off after the end of cooking (End).	Turn the function selector knob to 0 The time will appear.	
	dEF = defrost The “defrosting frozen food” function has been set.	To turn the oven off turn the function selector knob to 0 .	
		End with AUTO flashing and audible signal. End of the programmed cooking.	Press any programmer key to silence the audible signal OFF appears (see specific note).
		00.00 with bell symbol flashing and audible signal. End of the timer countdown.	Press any programmer key to silence the audible signal. The time appears.
	Start of the Pyrolysis cycle.	To increase the cycle length, up to max 3 hours, press key 2 of the programmer then key 6. To reduce to the minimum 1 hour 30 minutes press key 2 of the programmer and then key 5.	
	<p>P0.00 with P flashing. This appears after do.Lo, because the function selector knob has been moved from the Pyrolysis function to a cooking function. The temperature has dropped below 300°C. The key LED goes out and the door unlocks.</p>	Turn the oven selector knob to 0 and repeat the operations to start the Pyrolysis cycle.	
	P0.00 with P flashing. The oven selector knob has been moved to the Pyrolysis function (P).	To start the Pyrolysis cycle press key 3 of the programmer. To cancel the operation turn the oven function selector knob to 0 .	
	AUTO flashing. End of the pyrolysis cycle. This message remains until the door unlocks.	Wait for the door to unlock.	

PROGRAMMER MESSAGE		MESSAGE MEANING	WHAT TO DO
		<p>After the Pyrolysis cycle AUTO and P flashing. The door is unlocked and can be opened.</p>	<p>Turn the oven function selector knob to 0.</p>
	<p><i>door locked</i></p>	<p>During the Pyrolysis cycle There has been a power cut.</p>	<p>Turn the function selector knob to 0 and wait for the flashing 12.00 to appear. Then start the programmer, set the time and start the pyrolysis cycle again. If the display goes out see the specific chapter.</p>
		<p>During the Pyrolysis cycle The oven function selector knob has been moved from the Pyrolysis function to a cooking function. The oven cavity temperature is higher than 300°C.</p>	<p>Wait for the door to unlock. This happens automatically when the temperature inside the oven has dropped below 300°C (key LED goes out); P0.00 will appear with P flashing. Turn the oven selector knob to 0 and repeat the operations to start the Pyrolysis cycle.</p>
		<p>During the Pyrolysis cycle The oven function selector knob has been moved to 0 to cancel the Pyrolysis cycle. The oven cavity temperature is higher than 300°C.</p>	<p>When the door unlocks, which happens automatically when the temperature inside the oven has dropped below 300°C (key LED goes out), the time will appear on the display again.</p>
		<p>During a cooking function Oven operation fault.</p>	<p>Turn the function selector knob to 0 and wait for the oven to cool down so that the door unlocks. Then unplug the oven and call the After-Sales Service.</p>
		<p>door flashing and cooking symbol on. Waste of energy symbol. The oven door is open while cooking is taking place.</p>	<p>Close the oven door.</p>
		<p>door flashing, cooking symbol on and audible signal. Waste of energy symbol. The oven door has been open for 5 minutes while cooking is taking place.</p>	<p>Close the oven door and press any programmer key to switch the audible signal off.</p>

PROGRAMMER MESSAGE		MESSAGE MEANING	WHAT TO DO
		door. The oven function selector knob has been turned to the pyrolysis function with the oven door open.	Close the oven door and repeat the operations to start the Pyrolysis cycle.
		door flashing and audible signal. The function selector knob has been turned to the pyrolysis function for 5 minutes with the oven door open.	Close the oven door, press any programmer key to switch off the audible signal and repeat the operations to start the Pyrolysis cycle.
		door with AUTO flashing. The oven door has been opened with the Pyrolysis cycle in progress. The Pyrolysis cycle cancels.	Close the oven door and repeat the operations to start the Pyrolysis cycle.
		door with AUTO flashing and audible signal. The oven door has been opened for 5 minutes with the Pyrolysis cycle in progress. The Pyrolysis cycle is cancelled.	Close the oven door, press any programmer key to switch off the audible signal and repeat the operations to start the Pyrolysis cycle.
		Temperature sensor measurement error during the Pyrolysis cycle. This may be due to the Pyrolysis cycle being stopped and started again when it was quite a way through.	Turn the oven selector knob to 0 . Wait for at least 15 minutes before repeating the operations to start the Pyrolysis cycle.
		Oven temperature sensor broken or not working properly. The cooling fan stays on in every cooking function and if the pyrolysis cycle is in progress the door stays locked.	Turn the function selector knob to 0 . The 30 minute countdown will start (see below).
		30 F0 or 30 F1 . 30' countdown. If the selector knob is turned and then returned to 0 the count starts again from 30.	Wait for the countdown to stop. The fan stops and the door, if locked, unlocks. Unplug the oven and contact the After-Sales Service because the oven can no longer be used.
		Programmer with display off.	Turn the function selector knob to 0 , wait for the oven to cool down completely, switch the electricity off for a few seconds. If after this procedure the display is still off unplug the oven and contact the After-Sales Service. The oven must not be used.

2c. The oven function selector has been moved to 0 (oven OFF) to cancel the Pyrolysis cycle.

What to do:

1. Wait for the door to unlock. This happens automatically when the temperature inside the oven has dropped below 300°C.
2. The time appears and the oven can be used.



3. do.Lo appears during cooking

Oven not working properly.

What to do:

1. Turn the function selector to **0** (oven OFF),
2. Wait for the oven to cool down completely so that the door opens
3. Disconnect the oven from the mains.
4. Call the After-Sales Service Centre.



4. Display OFF

Oven not working properly.

What to do:

1. Turn the function selector to **0** (oven OFF)
2. Wait for the oven to cool down completely so that the door opens
3. Switch the oven off for a few seconds.



If after this procedure the display is still off:

4. Disconnect the oven from the mains.
5. Call the After-Sales Service Centre. The oven must not be used.

COOKING ADVICE

STERILIZATION

Sterilization of foods to be conserved, in full and hermetically sealed jars, is done in the following way:

- Turn the switch to position  or .
- Set the thermostat knob to position 175 °C and preheat the oven.
- Fill the grill pan with hot water.
- Set the jars into the grill pan making sure they do not touch each other and the door and set the thermostat knob to position 130 °C.

When sterilization has begun, that is, when the contents of the jars start to bubble, turn off the oven and let cool.

REGENERATION

Turn the switch to position  or  and set the temperature to 150°C.



Bread becomes fragrant again if wet with a few drops of water and put into the oven for about 10 minutes.

ROASTING

To obtain classical roasting, it is necessary to remember:

- the pre-set temperature should be maintained
- that the cooking time depends on the quantity and the type of foods.

COOKING DIFFERENT DISHES AT THE SAME TIME

The MULTIFUNCTION oven at positions  or  and  of the function selector can cook various different foods at the same time. Fish, cakes and meat can be cooked together without the smells and flavours mixing.

The only precautions required are the following:

- The cooking temperatures must be as close as possible with a maximum difference of 20° - 25°C between the different foods.
- Different dishes must be placed in the oven at different times according to the cooking time required for each one. This type of cooking obviously provides a considerable saving on time and energy.

USE OF THE GRILL

Turn the switch knob to position . Set the temperature if a temperature different from the pre-set one is required.

Leave to warm up for approximately 5 minutes with the door **closed**.

Introduce the food to be cooked, positioning the grill pan as close to the grill as possible. The dripping pan should be placed under the rack to catch the cooking juices and fats.

Always grill with the oven door closed.

COOKING WITH FAN GRILL (only in models without turnspit)

Grilling may be done by selecting grill+fan setting  with the function selector knob, because the hot air completely envelops the food that is to be cooked. Set the temperature if a temperature different from the pre-set one is required.

Simply put the food on the shelf.

Put the drip tray under the shelf to collect the cooking juices.

Close the door and let the oven operate until grilling is done.

Adding a few dabs of butter before the end of the cooking time gives the golden “au gratin” effect.

Grilling with the oven door closed.

COOKING ON THE GRILL WITH TURNSPIT (only in some models) (Fig. 2.4)

Proceed as follows:

- Put the drip tray in the last rung from the bottom and mount the spit support.
 - Put the meat to be cooked on the spit making sure that it is fixed centrally with the forks.
 - Put spit “A” into the motor hole moving the protection deflector “B” sideways. If the spit is inserted correctly it cannot be turned with the hands.
 - Put the spit collar “D” on support “C”; then remove the heat-protection handgrip turning it anticlockwise.
-
- Switch the oven on positioning the function selector knob on position . Make sure that the spit turns.
 - Set the temperature if a temperature different from the pre-set one is required.

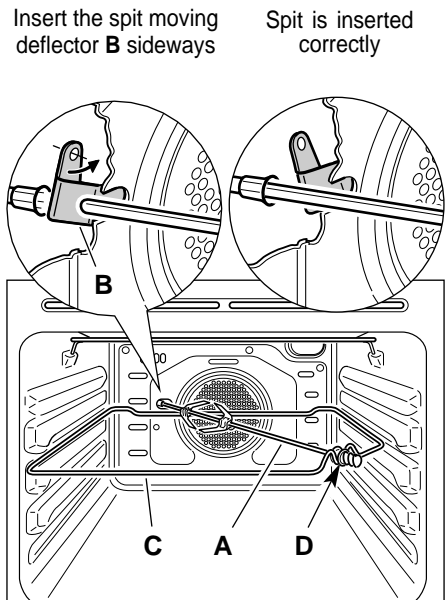

Fig. 2.4

ATTENTION: the oven door becomes very hot during operation. Keep children away.









IMPORTANT: In all cooking functions the oven must always be used with the door closed.

How to use the electronic programmer

3

- The electronic programmer is a device which groups together the following functions:
- 24 hours clock with illuminated display
 - Timer (up to 23 hours and 59 minutes)
 - Program for semi-automatic oven cooking.
 - Program for automatic oven cooking
 - Management of the cooking functions. The programmer can manage setting the temperature in the various cooking functions.
 - Management of the pyrolysis function.

Description of the pushbuttons:

-  Timer (1)
-   Cooking time or pyrolysis time (2)
-   End of cooking time or allowance to start pyrolysis cycle (3)
-  Setting oven temperature (4)
-  Countdown of the figures of all the functions or of the temperature to be set (5)
-  Advance of the figures of all the functions or of the temperature to be set (6).

Description of the light symbols:

AUTO Indicates that a programme has been set

 Indicates that the heating elements are working

 Indicates that the timer is working

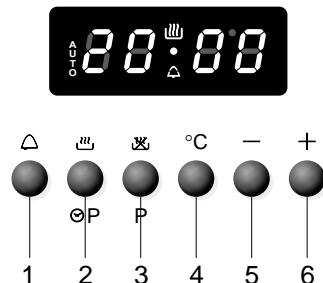
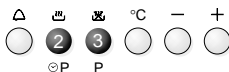

Fig. 3.1

ON SWITCHING ON FOR THE FIRST TIME OR AFTER A BLACK-OUT



After the appliance has been connected to the mains or after there has been a black-out the programmer must be activated so that it can work.

12:00 flashes on the display.

1. Press keys 2 and 3 at the same time.
The programmer starts to work.

SETTING THE TIME

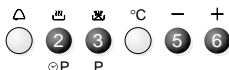

The programmer has an electronic clock with luminous figures which indicate hours and minutes.

Note: Setting the clock will zero any programmes in progress or set.

1. Press pushbuttons 2 and 3 at the same time.
2. Press pushbuttons 5 or 6 until the exact time is set. During this phase the dot between hours and minutes will flash on the display. If the plus or minus keys are kept pressed for a few seconds, the figures will scroll more quickly.

AUDIBLE SIGNAL

The intermittent audible signal, duration 30 seconds, sounds when the timer or semi-automatic or automatic cooking have reached the end of the time set. It also sounds to signal that the door is open (see oven use chapters).

To silence the audible signal press any of the programmer keys

TIMER

The timer function is only used to count the time and does not influence oven operation or any programmes which are in progress or set.

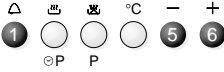

1. Press pushbutton 1. The bell symbol will start to flash.
2. Press keys 5 or 6 to set the time required.
3. The countdown starts immediately. The bell symbol stops flashing and the time appears again.
4. To see the countdown press pushbutton 1. The time will be indicated in hours and minutes; the seconds are only indicated for the last minute.
5. At the end of the countdown an audible signal sounds and the bell symbol on the display flashes.
Press any pushbutton to stop the audible signal.

SEMI-AUTOMATIC COOKING

Start immediate cooking or switch the oven off automatically after the programmed cooking time.

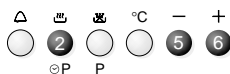
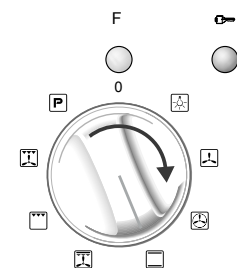

Setting

1. Set the cooking function by turning the oven selector to the function required.
2. The cooking temperature appears on the display. To change it proceed as described in the Setting the cooking chapter
3. Press pushbutton 2. **AUTO** starts to flash and **0.00** appears.
4. Press pushbuttons 5 or 6 to set the cooking time (cooking time in hours and minutes: set it to ten minutes less than the time required because the stored heat will complete the cooking).
5. On the display **AUTO** becomes steady and the cooking programme starts.

During cooking

6. During the cooking cycle, the display shows the oven temperature measured by the probe.
Press key 2 to display the time remaining until the end of cooking.
The cooking time and temperature can be varied at any time, as described above.

At the end of cooking

7. **End** appears on the display, **AUTO** flashes and the audible signal sounds.
The cooking cycle has finished and the oven is OFF.
8. Press any programmer pushbutton to stop the audible signal.
9. **OFF** appears (oven OFF).
10. Turn the function selector to **0** (oven OFF).
11. The programmer display shows the time.

Note: At the end of the programme always turn the function selector knob to **0** (oven OFF).

AUTOMATIC COOKING

Start cooking at the programmed time and switch the oven off automatically after the programmed cooking time.

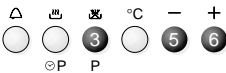
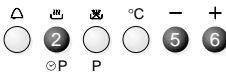
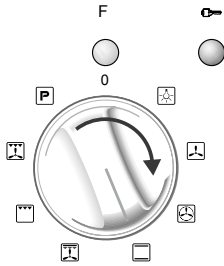

Setting

1. Set the cooking function by turning the oven selector to the function required.
2. The cooking temperature appears on the display. To change it proceed as described in the Setting the cooking chapter.
3. Press pushbutton 2. **AUTO** starts to flash and **0.00** appears.
4. Press pushbuttons 5 or 6 to set the cooking time (cooking time in hours and minutes: set it to ten minutes less than the time required because the stored heat will complete the cooking).
5. On the display **AUTO** becomes steady and the cooking programme starts.
6. Press pushbutton 3 (**AUTO** starts to flash).
7. Press pushbuttons 5 or 6 to set the time when the cooking should finish.
The values set must be correct; e.g. if it is 08:00 a cooking time of 3 hours, ending at 10:00, cannot be set. In this case the programmer automatically sets the end of cooking time for 11:00.
8. On the display **AUTO** becomes steady and the time appears again. The cooking symbol goes out.

Starting cooking

9. The pan symbol lights up. The oven switches on and the cooking cycle set starts.



During cooking

- 10.** During the cooking cycle, the display shows the oven temperature measured by the probe.

Press key 2 to display the length of cooking set.

Press key 3 to display when the cooking will finish.

The cooking time, end of cooking time and cooking temperature can be varied at any time, as described above.

At the end of cooking



- 11.** **End** appears on the display, **AUTO** flashes and the audible signal sounds.

The cooking cycle has finished and the oven is OFF.

- 13.** Press any pushbutton to stop the audible signal.

- 14.** **OFF** appears (oven OFF).

- 15.** Turn the function selector to **0** (oven OFF).

- 16.** The programmer display shows the time.



Note: At the end of the programme always turn the function selector knob to **0** (oven OFF).

CANCELLING A SET PROGRAMME

To cancel any programme just turn the function selector to **0** (oven OFF).

Note: if during a set programme the function selector is turned to **0** (oven OFF), **P** (pyrolysis) or **oven lighting**, the programme is cancelled.

EXAMPLES OF PROGRAMMING AUTOMATIC COOKING

② Time needed to cook the food (2 hours)

③ Time when the food to be cooked must be ready

① Time when cooking the food is programmed (08:00)

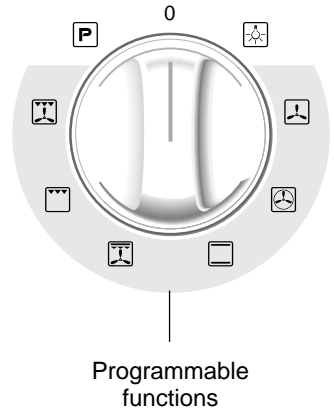
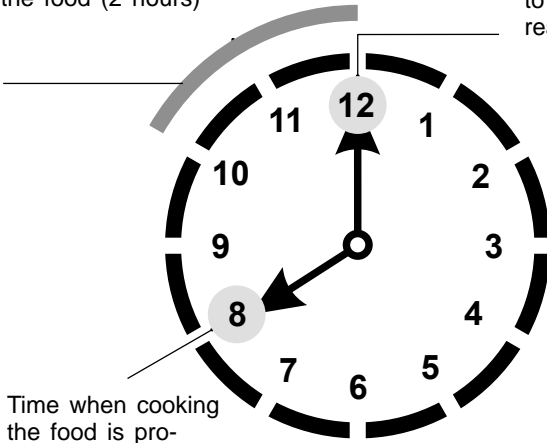

①

②

③

Fig. 3.2

GENERAL ADVICE

Important:

Before any operation of cleaning and maintenance disconnect the appliance from the electrical supply.

It is advisable to clean when the appliance is cold and especially for cleaning the enamelled parts.

Avoid leaving alkaline or acidic substances (lemon juice, vinegar, etc.) on the surfaces. Avoid using cleaning products with a chlorine or acidic base.

The oven must always be cleaned after every use, using suitable products and keeping in mind that its operation for 30 minutes on the highest temperature eliminates most grime reducing it to ashes.

Before starting the pyrolysis cycle do not spray any degreasing products or detergents on the oven walls.

CLEANING THE OVEN CAVITY

The oven has a specific "PYROLYSIS FUNCTION" which can clean the cavity by pulverising the residual cooking greases by high temperature.

Do not wait for the oven to be very greasy before performing this cleaning. It should not be performed after every cooking, either, but only when the level of dirt justifies it (on average 1 – 2 times a month depending on oven use).

To use this function see the specific chapters: "Selecting the functions – PYROLYSIS FUNCTION", "How to start the pyrolysis cycle", "Problems in starting and during the pyrolysis cycle", "How to stop the pyrolysis cycle" and "What to do when the pyrolysis cycle has finished".

Take the drip tray, shelf and grease filter (if fitted) out of the oven. They can be washed in the sink.

ENAMELLED PARTS

All the enamelled parts must be cleaned with a sponge and soapy water only or other non-abrasive products.

Dry preferably with a chamois leather.

STAINLESS STEEL AND ALUMINIUM PARTS AND SILK-SCREEN PRINTED SURFACES

Clean using an appropriate product. Always dry thoroughly.

IMPORTANT: these parts must be cleaned very carefully to avoid scratching and abrasion. You are advised to use a soft cloth and neutral soap.

Do not use a steam cleaner because the moisture can get into the appliance thus make it unsafe.

Do not store flammable material in the oven.

STAINLESS STEEL SURFACES WITH ANTI-FINGERPRINT TREATMENT

CAUTION:

The stainless steel surfaces used in some ovens are protected with a Special Lacquer to reduce finger-print marks.

To avoid damaging this lacquer, do not clean the stainless steel with abrasive cleaners or abrasive cloths or scouring pads.

ONLY SOAP/WARM WATER MUST BE USED TO CLEAN THE STAINLESS STEEL SURFACES.

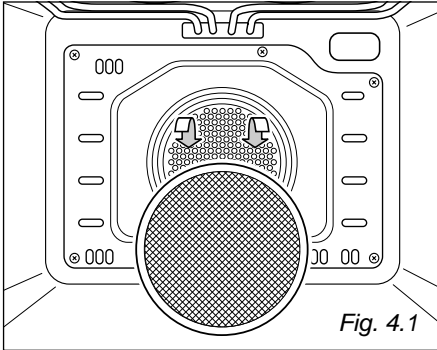

Fig. 4.1

GREASE FILTER (some models only)

- Slide in the grease filter on the back of the oven as in fig. 4.1.
- **Clean the filter after any cooking!**
The grease filter can be removed for cleaning and should be washed regularly in hot soapy water (fig. 4.1).
- Always dry the filter properly before fitting it back into the oven.

CAUTION: THE FILTER MUST BE TAKEN OUT OF THE OVEN BEFORE STARTING THE PYROLYSIS CYCLE.



Fig. 4.2

REPLACING THE OVEN LIGHT (fig. 4.2)

Before any maintenance is started involving electrical parts of the appliance, it must be disconnected from the power supply.

- Let the oven cavity and the heating elements cool down;
- Switch off the electrical supply;
- Unscrew the protective cover (fig. 4.2);
- Unscrew and replace the bulb with a new one suitable for high temperatures (300°C) having the following specifications: 230-240V 50 Hz, 15W, E14
- Refit the protective cover

NOTE: Oven bulb replacement is not covered by your guarantee.

OVEN FITTING OUT

The oven shelves are provided with a security block to prevent accidental extraction. They must be inserted operating as per figure 4.3.

To pull them out operate in the inverse order.

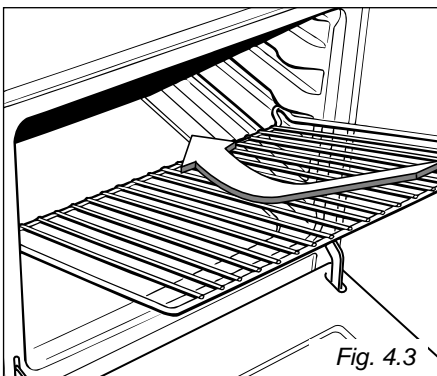
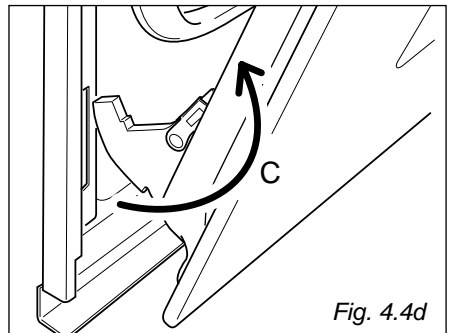
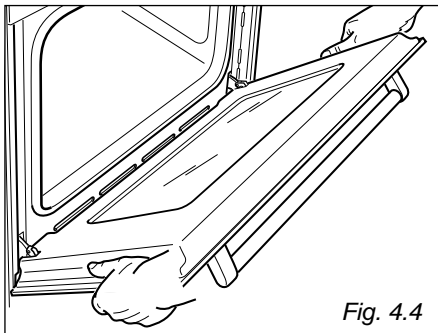
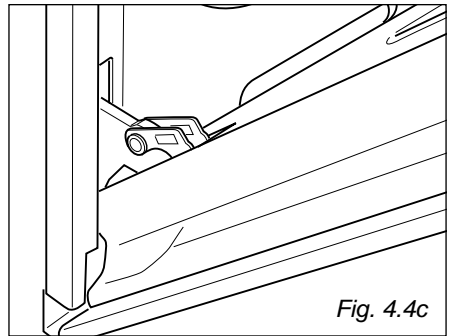
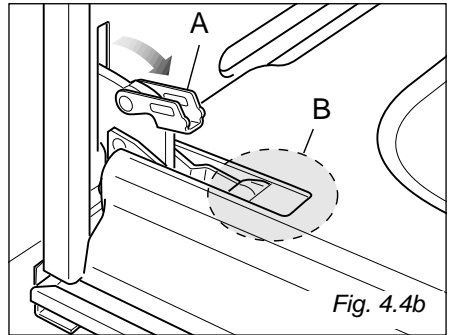
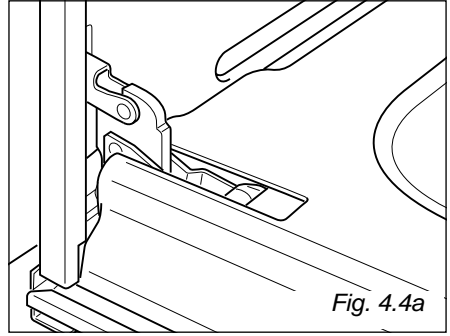

Fig. 4.3

REMOVING THE OVEN DOOR

The oven door can easily be removed as follows:

- Open the door to the full extent (fig. 4.4a).
- Open the lever “A” completely on the left and right hinges (fig. 4.4b).
- Hold the door as shown in fig. 4.4.
- Gently close the door (fig. 4.4) until left and right hinge levers “A” are hooked to part “B” of the door (fig. 4.4b).
- Withdraw the hinge hooks from their location following arrow “C” (fig. 4.4d).
- Rest the door on a soft surface.
- To replace the door, repeat the above steps in reverse order.



Advice for the installer

Installation

5

IMPORTANT

- The appliance should be installed by a **QUALIFIED INSTALLATION TECHNICIAN**. The appliance must be installed in compliance with regulations in force.

The oven can be fitted in standard units, width and depth 60 cm. Installation requires a compartment as illustrated in figures 5.1 and 5.2. On the lower side, the oven must lay on supports standing the oven weight. The 4 screws serve as fixing.

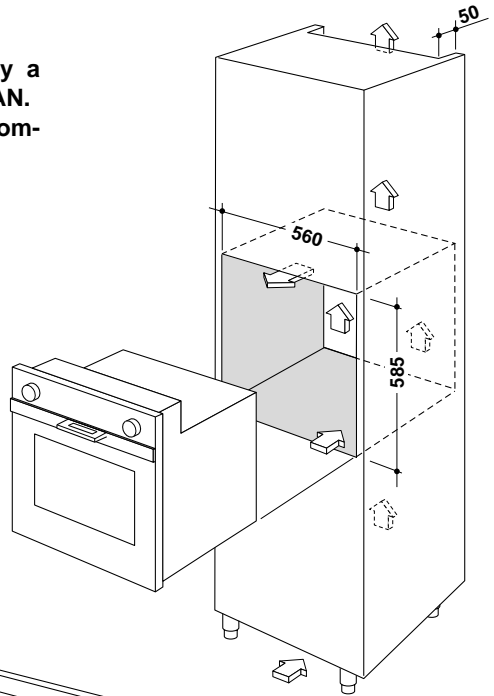

Fig. 5.1

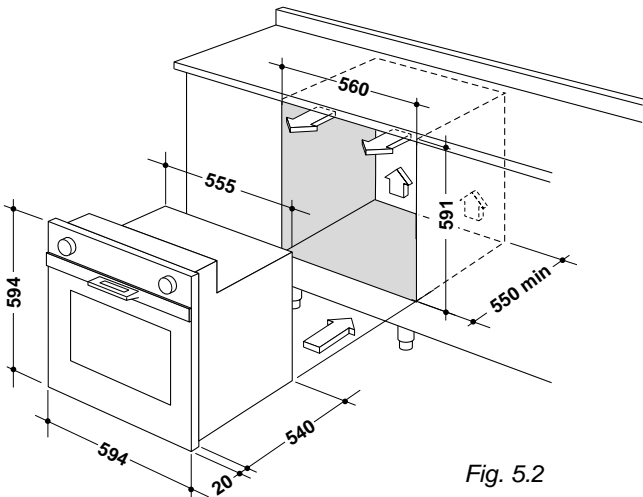

Fig. 5.2

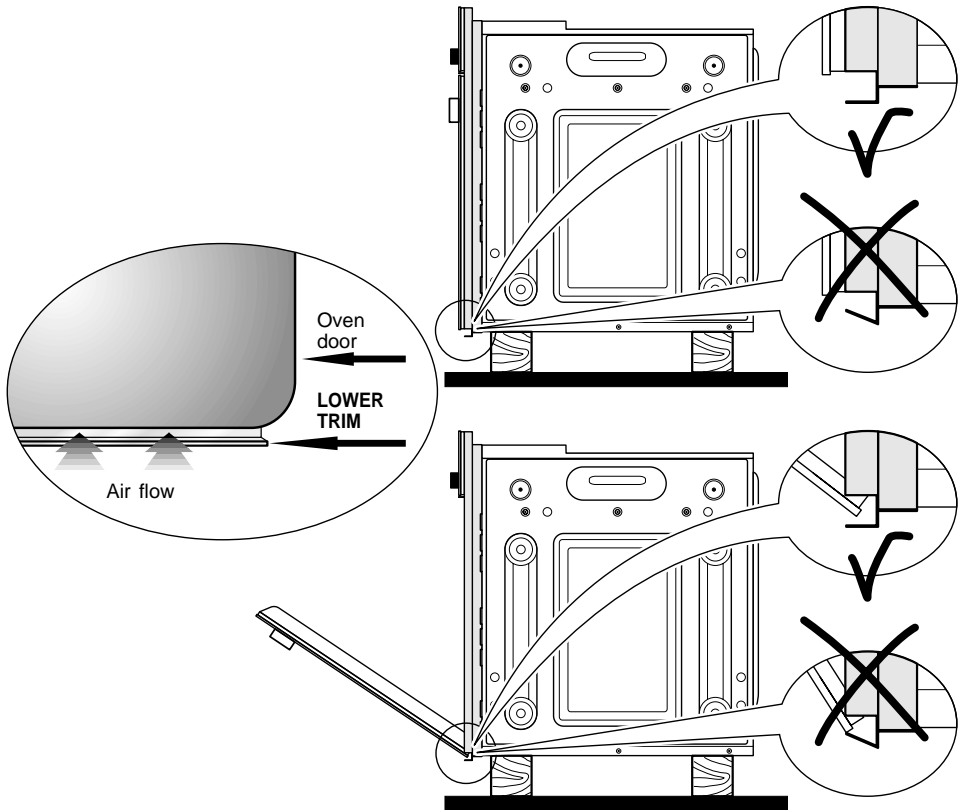

Fig. 5.3

IMPORTANT:

To avoid damage to the lower trim please note the following instructions.

The lower trim is designed to allow for good air circulation and the correct opening of the oven door.

To ensure the trim is not damaged due to the appliance being placed on the floor, the appliance should be suitably supported as in above illustrations.

After installation the appliance door should be slowly opened to ensure no damage has occurred.

No responsibility for lower trim damage will be accepted if these instructions have not been followed.

Before effecting any intervention on the electrical parts the appliance must be disconnected from the network.

GENERAL

- The connection to the electrical network must be carried out by qualified personnel and must be according to existing norms.
- The appliance must be connected to the electrical network verifying above all that the voltage corresponds to the value indicated on the specifications plate and that the cables section of the electrical plant can bear the load which is also indicated on the plate.
- If the oven is supplied without a plug and is not connected directly to the mains, a standard plug, suitable for the load, must be fitted.
- The colours of the wires in the appliance power cable may not correspond with the colours marked on the terminals of your electrical plug. The plug should always be wired as follows:
 - connect the green/yellow wire to the terminal marked with the letter E or the earth symbol or coloured green/yellow;
 - connect the blue wire to the terminal marked with the letter N or coloured black;
 - connect the brown wire to the terminal marked with the letter L or coloured red.
- The bi-polar plug must be connected to an outlet connected to the grounding unit in conformity to security norms.
- If the oven is to be connected directly to the mains, it must be placed with an omnipolar switch with minimum opening between the contacts of 3 mm between the appliance and the mains.
- The power supply cable must not touch the hot parts and must be positioned so that it does not exceed 75°C at any point.
- Once the oven has been installed, the switch or socket must always be accessible.
- If the power supply cable is damaged it must be substituted by a suitable cable available in the after sales service.
- When using the appliance do not touch the heating elements inside the oven cavity.

**The connection of the appliance to the grounding unit is mandatory.
The manufacturer declines every responsibility for any inconvenience resulting from the inobservance of this condition.**

N.B. For connection to the mains, do not use adapters, reducers or branching devices as they can cause overheating and burning.

If the installation requires alterations to the domestic electrical system call an expert. He should also check that the socket cable section is suitable for the power absorbed by the appliance.

CONNECTION OF THE POWER SUPPLY CABLE

Unhook the terminal board cover by inserting a screwdriver into the two hooks "A" (fig. 6.1).

Open the cable gland by unscrewing screw "F" (fig. 6.2), unscrew the terminal screws and remove the cable.

The new supply cable, of suitable type and section, is connected to the terminal board following the diagram fig. 6.3.

FEEDER CABLE SECTION TYPE H05RR-F

230 V ~

3 x 1,5 mm²

