



C224SS

Caple Fan Oven Stainless Steel



INSTRUCTION MANUAL

Thank you for buying your new CAPLE Built-Under Oven. To ensure that you get the best results from your new CAPLE oven, we strongly suggest that you read this instruction manual thoroughly before use. This manual contains installation advice, cleaning tips and a cooking guide, as well as other important facts about your CAPLE oven. If treated with care, your CAPLE oven should give you years of trouble-free cooking.

Safety Reminders	3
Electrical Requirements	4
Electrical Installation	5
How To Install Your Oven	6
Multifunction Ovens	10
Electric Fan Ovens	16
Alarm 60'.....	21
Cut-off Timer 120'.....	21
Electronic Timer	22
Electronic Programmer	23
Analogical Programmer	26
Cleaning and Maintenance.....	29
Helpful Advice	30
Cooking Guide	31
Your Guarantee	32

**For Spare Parts, Technical Advice
or Product Service call the
CAPLE HELPLINE on 0870 241 1142**

(Answerphone outside office hours)

Safety Reminders

Instruction Book

This appliance should only be used for its intended purpose as described in these instructions.

Ensure that you fully understand these instructions before operating this appliance.

Space Requirements

Ensure that the specified ventilation space around the appliance is not obstructed.

Food Splashes

Always wipe clean the oven after use. Food splashes can carry on cooking next time and may become a fire hazard.

Hot Surfaces

It is important to remember that the surfaces of cooking appliances get hot during use and retain the heat for some time after switching off.

It is therefore advisable to keep small children away from the appliance.

The Grill and Top oven element (multifunction ovens only)

are exposed, so take great care when placing food in the oven or removing it. Use the grill pan handles or gloves.

DO NOT line the oven, grids, trays etc. with aluminium foil as this could adversely affect the heating elements and it could also damage the interior surfaces.

DO NOT place flammable materials in the oven.

Faults

Do not continue to use this appliance if it appears to be faulty.

After Use

Switch the oven controls off.

Always switch off at the isolating switch before cleaning the appliance, or attempting any maintenance task, or when not in use for long periods (when on holiday).

CAPLE Service

To ensure the continued safe and efficient operation of this appliance, we recommend that any servicing or repairs are carried out only by an authorised CAPLE SERVICE ENGINEER.

Electrical Requirements

**WARNING!
ELECTRICITY CAN BE
EXTREMELY DANGEROUS.
THIS APPLIANCE MUST BE
EARTHED.**

This Installation should be carried out by a competent electrician in accordance with current I.E.E. Regulations.

This CAPLE product must be connected to an electricity supply at the voltage shown on the rating plate. Connection must be made via a double pole isolating switch with a contact separation of at least 3 mm.

Use supply cable, having a minimum conductor cross-sectional area of 1.5 mm².

Where both hob unit and **an oven are to be installed adjacent to each other, both appliances may be supplied via the same double pole isolating switch** using separate supply cables. Check that the total loading of the installation is within the capacity of the double pole isolating switch and the supply circuit.

Allow sufficient length in the supply cable(s) for removal of the appliance(s) for any subsequent servicing. Ensure that this extra cable is not trapped and is not in contact with the underside of any hob when fitting the appliance(s) in position.

As with all electrical appliances always switch off the electricity supply when not in use for long periods (when on holiday) and before attempting any maintenance task.

Fitting Into position

Your new CAPLE oven is designed to fit into a kitchen unit which is at least 550 mm deep.

Before proceeding with the installation, check that the oven will fit into the space intended for it, appropriate ventilation slots are provided as per installation instructions on page 6 and that all packing material has been removed.

IMPORTANT

Materials used to build the oven housing must be capable of withstanding temperatures of up to 100°C and the housing must be firmly fixed in position.

Before Use

Check that all accessories have been removed from the oven interior.

Set the temperature to 225°C (fan ovens) or 250°C (multifunction ovens) using the temperature control knob.

Leave on for approximately 30 minutes. This will burn off any protective coating applied to the oven during manufacture.

The kitchen should be well ventilated during this time as there may be an odour given off.

When cool, wash the accessories and the oven with warm water and mild detergent.

Electrical Installation

This appliance must be connected to a double pole isolating switch (fig. 1) and to the terminal block in the oven (figs. 2 & 3) using the following guide:

- 1) The wire which is coloured brown must be connected to the terminal marked **L** (Live), or coloured Red.
- 2) The wire which is coloured blue must be connected to the terminal marked **N** (Neutral), or coloured Black.
- 3) The wire which is coloured green and yellow must be connected to the terminal marked **E** (Earth) ⏏ or coloured Green.

IMPORTANT: These connections must be carried out by a qualified electrical engineer.

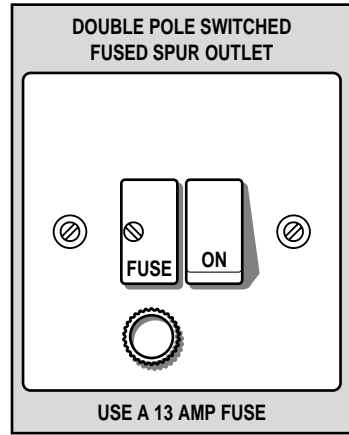

Fig. 1

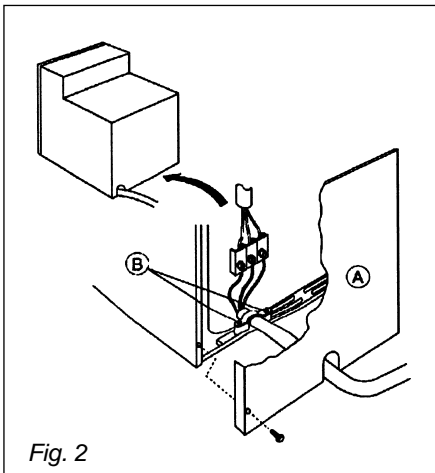

Fig. 2

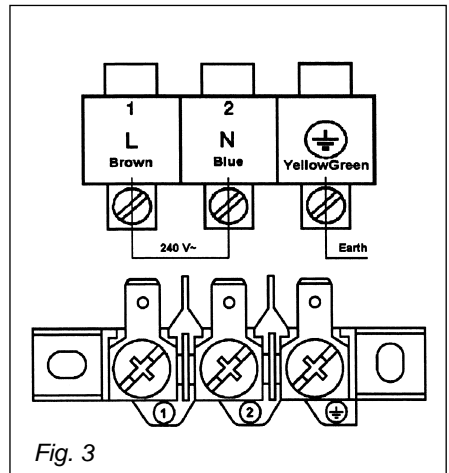

Fig. 3

How To Install Your Oven

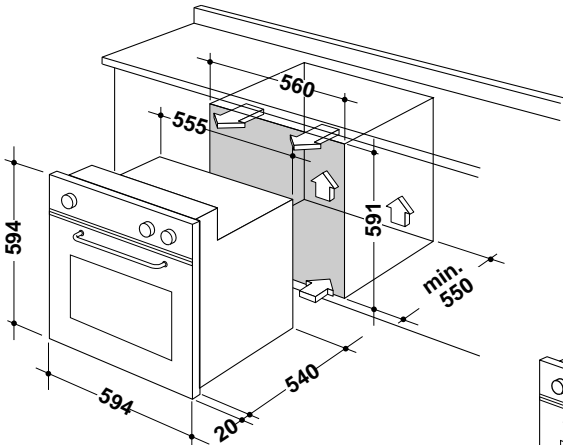

Fig. 4 - Built under

You need the following housing area to fit your oven correctly.

Dimensions (mm)	Oven	Housing
Height	594	585 Built in 591 Built Under
Width	594	560
Depth	560	550

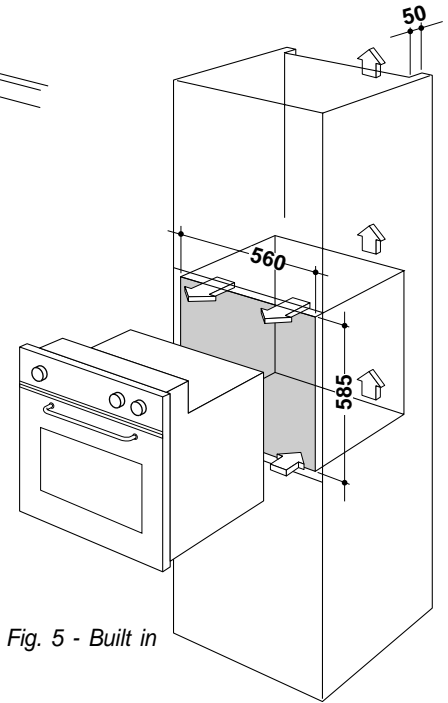

Fig. 5 - Built in

The oven is designed to fit into a cabinet 600 mm wide. The oven can be built-in or built-under the kitchen units.

It is essential that the oven housing is well ventilated.

If the oven is being installed into a fully enclosed built-under oven housing (fig. 4) it may be necessary to cut a small slot in the top of the plinth panel fitted under the unit. Cut a section 400 mm wide and a minimum of 15 mm high to allow air to pass under the unit.

Also ensure that the front rail the top of the unit is not installed as it could restrict ventilation.

If the oven is being built in to a kitchen unit (fig. 5) ensure that the oven is ventilated with a 50 mm space at the top of the kitchen unit.

How To Install Your Oven

Failure to allow adequate ventilation for the appliance may result in over heating or damage to adjacent units.

Caple does not accept any responsibility for any damage caused due to non-compliance with these instructions.

To install the oven into a kitchen unit (fig. 5) first ensure that the oven housing is firmly secured to the wall and/or adjacent fittings.

Lift the oven carefully into position on the shelf, taking care **NOT** to lift it by the door handle.

If you lower the oven door, you will see four screw holes, two on each side of the oven. The oven should then be secured to the housing by fitting screws into these holes.

To ensure internal ventilation, aeration channels must be provided as illustrated in the figures 6 and 7.

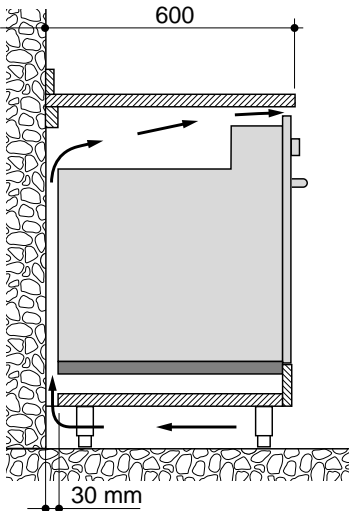

Fig. 6

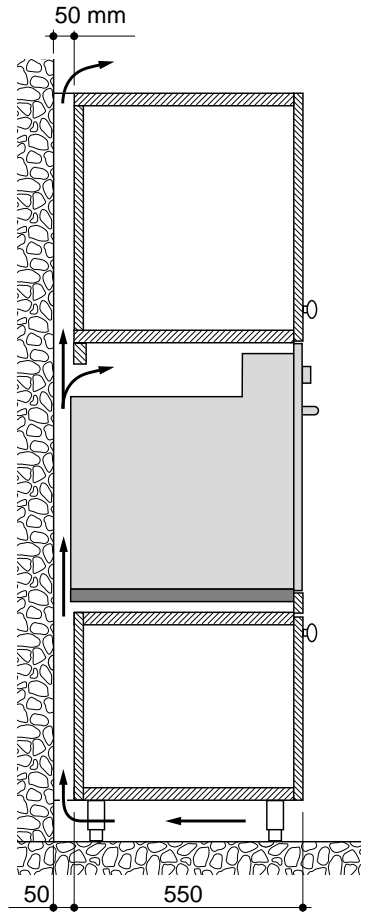

Fig. 7

How To Install Your Oven

The rating plate can be found on the bottom right hand side of the inner door.

Clean the oven thoroughly before using it for the first time; use water and soap, then rinse carefully.

Once the above operations are completed, heat the oven to the max. temperature for about one and a half hours so as to eliminate any residual factory grease that might impart unpleasant smells to the meals being cooked.

Models with hump wall oven

Fitting up of oven shelves

The oven shelves are provided with a security block to prevent accidental extraction. They must be inserted operating as per bottom figure 8.

To pull them out operate in the inverse order.

Important:

As a safety measure, before you start cleaning the oven be sure to disconnect it from the mains supply.

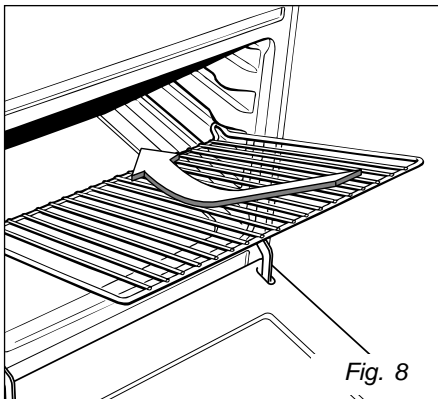

How To Install Your Oven

Models with smooth wall oven

Assembling and removing the side racks

- Fit the side runner frames into the holes on the side walls inside the oven (Fig. 9).
- Slide the drip pan and rack into the runners as shown in Fig. 10.

The rack must be fitted so that the safety catch, which stops it sliding out, faces the inside of the oven.

- To dismantle, operate in reverse order.

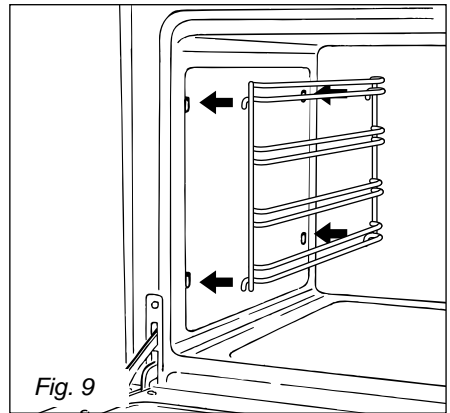

Important:

As a safety measure, before you start cleaning the oven be sure to disconnect it from the mains supply.

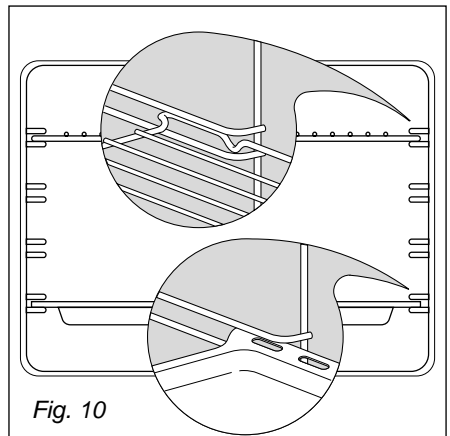

Multifunction ovens

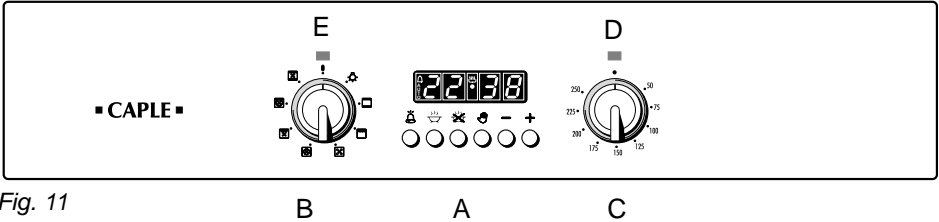

Fig. 11

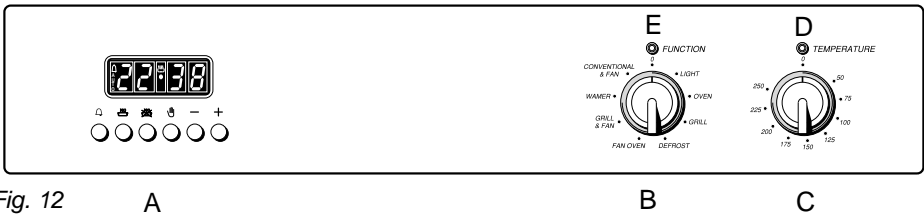

Fig. 12

Controls description

- A. Digital electronic programmer
- B. Oven switch knob
- C. Oven thermostat knob

Pilot lamp:

- D. Oven temperature indicator lamp
- E. Power on indicator lamp

General features

This is a MULTI-FUNCTION oven. As its name indicates, this is an oven that presents particular features from an operational point of view. In fact, it is possible to insert 7 different programs to satisfy every cooking need. The 7 positions, thermostatically controlled, are obtained by 4 heating elements which are:

- Lower element 1400 W
- Upper element 1000 W
- Grill element 2500 W
- Circular element 2500 W

7 - Function Oven

Operating principles

Heating and cooking in the MULTI-FUNCTION oven are obtained in the following ways:

- a. by normal convection. The heat is produced by the upper and lower heating elements.
- b. by forced convection
A fan sucks in the air contained in the oven muffle, which sends it through the circular heating element and then sends it back through the muffle. Before the hot air is sucked back again by the fan to repeat the described cycle, it envelops the food in the oven, provoking a complete and rapid cooking.
It is possible to cook several dishes simultaneously.
- c. by semi-forced convection
The heat produced by the upper and lower heating elements is distributed throughout the oven by the fan.
- d. by radiation
The heat is irradiated by the infra red grill element.
- e. by radiation and ventilation
The irradiated heat from the infra red grill element is distributed throughout the oven by the fan.

Fig. 13

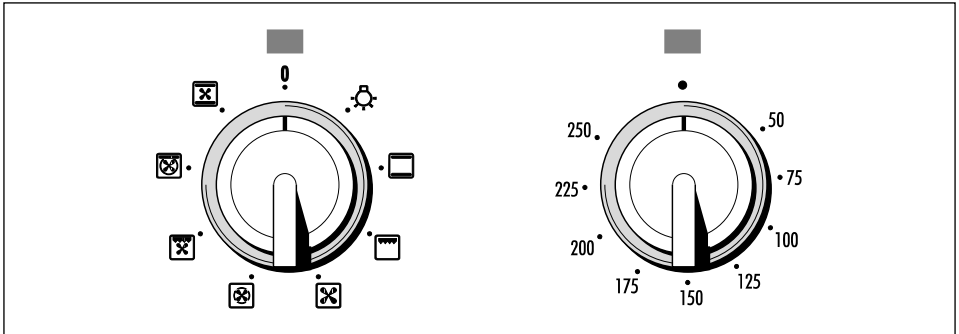
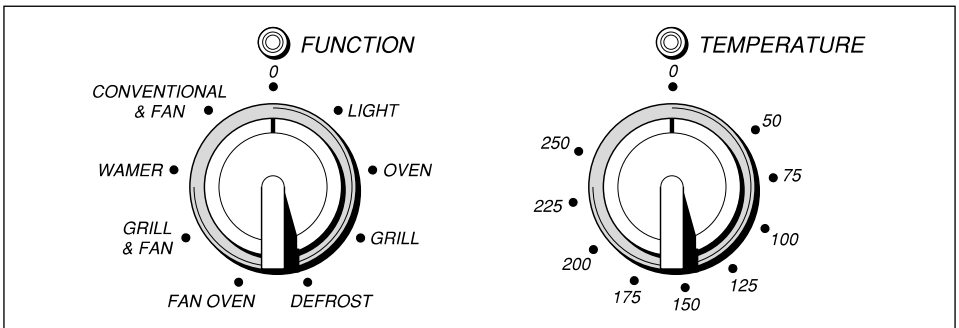

Fig. 14



7 - Function Oven

Thermostat knob

This only sets the cooking temperature and does not switch the oven on. Rotate clockwise until the required temperature is reached (from 50 to 250°C)

Function selector knob

Rotate the knob clockwise to set the oven for one of the following functions.



LIGHT

By setting the knob to this position, only the oven light comes on (15 W). It remains on in all the cooking modes.



OVEN

The upper and lower heating elements come on. The heat is dispersed by natural convection and the temperature must be set to between 50° and 250°C via the thermostat knob.

The oven must be preheated before cooking.

Recommended for:

Food that requires the same degree of cooking both inside and out, for example roasts, spare pork ribs, meringues etc.



GRILL

The infrared electrical resistance comes on. The heat is dispersed by radiation. Use with the thermostat knob set to **200°C** and the **oven door closed**. For cooking hints, see the chapter "GRILLING and AU GRATIN".

Caution: The oven door becomes very hot during operation. Keep children well out of reach.

Recommended for:

Intense grilling, browning, cooking au gratin and toasting etc.

It is recommended that you do not grill for longer than 30 minutes at any one time.



DEFROST

Only the oven fan comes on. Use with the thermostat knob set to "0" - other positions have no effect. The food is thawed by ventilation without heating.

Recommended for:

Quick thawing of frozen foods; one kg requires approximately 1 hour.

Thawing times vary according to the quantity and type of food to be thawed.

7 - Function Oven



FAN OVEN

The circular resistance and fan come on. The heat is dispersed by forced convection and the temperature can be regulated to between 50° and 250°C via the thermostat knob. The oven does not require preheating.

Recommended for:

Food which has to be well-cooked outside and soft or rosy inside, for example lasagne, lamb, roast beef, whole fish etc.



GRILL & FAN

The infrared grill and the fan come on. The heat is dispersed mainly by radiation and the fan then distributes it all over the oven.

Use with the door closed. The temperature can be regulated via the thermostat knob to between 50° and 175° max. The oven must be preheated for approximately 5 minutes. For cooking hints, see the chapter "GRILLING AND COOKING AU GRATIN."

Caution: The oven door becomes very hot during operation. Keep children well out of reach.

Recommended for:

Grilling where quick browning on the outside is required to keep the juices in. For example: veal steaks, chops, hamburgers etc.

It is recommended that you do not grill for longer than 30 minutes at any one time.



WARMER

The upper resistance, the circular resistance and the fan come on.

The heat is dispersed by forced convection with greater intensity in the upper part.

The temperature can be set to between 50° and 140°C via the thermostat knob.

Recommended for:

Keeping food warm after any type of cooking. Slow heating of cooked food.



CONVENTIONAL & FAN

The upper and lower heating elements come on and the fan.

The heat coming from above and below is dispersed by convection with ventilation.

The temperature can be set to between 50° and 250°C via the thermostat knob.

Recommended for:

Voluminous dishes and large quantities which require the same degree of cooking both inside and out, for example rolled roasts, turkey, roast legs, cakes etc.

7 - Function Oven

Cooking advice

Sterilization

Sterilization of foods to be conserved, in full and hermetically sealed jars, is done in the following way:

- Set the switch to position  **FAN OVEN**.
- Set the thermostat knob to position 185 °C and preheat the oven.
- Fill the dripping pan with hot water.
- Set the jars onto the dripping pan making sure they do not touch each other and the door and set the thermostat knob to position 135 °C. When sterilization has begun, that is, when the contents of the jars start to bubble, turn off the oven and let cool.

Regeneration

Set the switch to position  **CONVENTIONAL & FAN** and the thermostat knob to position 150° C.

Bread becomes fragrant again if wet with a few drops of water and put into the oven for about 10 minutes at the highest temperature.

Simultaneous cooking of different foods

The MULTI-FUNCTION oven set on position  **CONVENTIONAL & FAN** consents a simultaneous heterogeneous cooking of different foods.

Different foods such as fish, cake and meat can be cooked together without mixing the smells and flavors together. This is possible since the fats and vapors are oxidized while passing through the electrical element and therefore are not deposited onto the foods. The only precaution to follow are:

- The cooking temperatures of the different foods must be as close to as possible, with a maximum difference of 20° - 25 °C.
- The introduction of the different dishes in the oven must be done at different times in relation to the cooking times of each one.

The time and energy saved with this type of cooking is obvious.

Grilling and “au gratin”

Grilling may be done without the roasting jack on position  **GRILL & FAN** of the switch, because the hot air completely envelops the food that is to be cooked.

Set the thermostat to position 175 °C and after having preheated the oven, simply place the food on the rack.

Close the door and let the oven operate with the thermostat on position 175 °C, until grilling is done.

Adding a few dabs of butter before the end of the cooking time gives the golden “au gratin” effect.

It is recommended that you do not grill for longer than 30 minutes at any one time.

Attention: the oven door becomes very hot during operation. Keep children away.

7 - Function Oven

Roasting

To obtain classical roasting, it is necessary to remember:

- that it is advisable to maintain a temperature between 180 and 200 °C.
- that the cooking time depends on the quantity and the type of foods.

Use of the grill

Set the switch to position  **GRILL** and the thermostat to position **200 max.**

Leave to warm up for approximately 5 minutes with the door **closed**.

Introduce the food to be cooked, positioning the rack as close to the grill as possible.

The dripping pan should be placed under the rack to catch the cooking juices and fats.

Grilling with the oven door closed.

Grilling with the oven door closed and do not for longer than 30 minutes at any one time.

Attention: the oven door becomes very hot during operation. Keep children away.

Grease Filter

The inside of the oven can be easily cleaned with a wet cloth and oven cleaner.

As a safety measure, before you start cleaning the oven, make sure the electrical supply is switched off.

You should clean the oven when it is cold.

Do not leave acid or alkaline residues (lemon juice, vinegar, salt, tomato, etc) on the enamelled surfaces.

Avoid abrasive cleaning products on the painted parts.

A special screen is provided at the back of the fan oven to catch grease particles, mainly when meat is being roasted. When baking pastry etc, the filter should be removed.

Always clean the filter after cooking as any solid residues on it might adversely affect the oven performance.

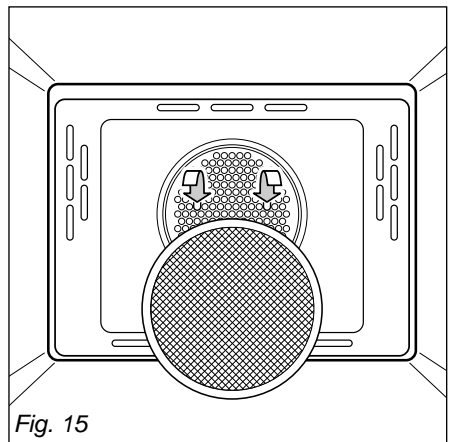

Fig. 15

Electric fan ovens

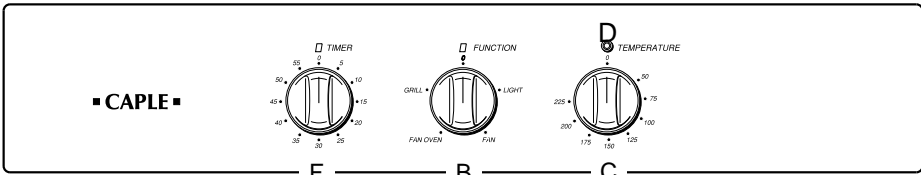

Fig. 16



Fig. 17

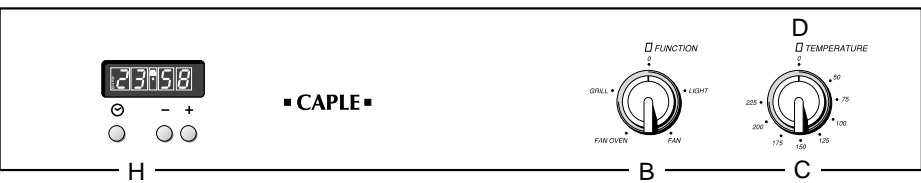

Fig. 18

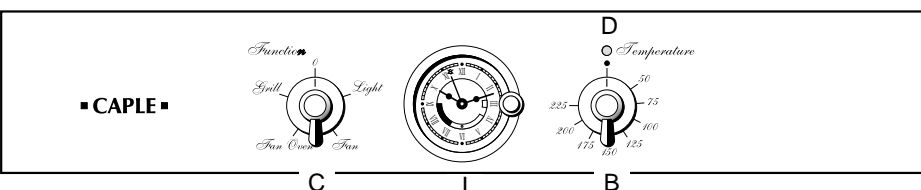

Fig. 19

Controls description

- F. Alarm 60'
- B. Oven switch knob
- C. Oven thermostat knob
- G. 120' cut-off timer knob
- H. Electronic timer (end cooking)
- 16 I. Electronic timer (start/end cooking)

Pilot lamp:

- D. Oven temperature indicator lamp

Electric Fan Oven

General features

The heating and cooking in electrical hot air ovens take place by forced convection.

The two elements which make this process take place are:

- Circular element 2500 W
- Grill element 2500 W

NOTE:

Upon first use, it is advisable to operate the oven at the maximum temperature (thermostat knob on position 225) for 60 minutes in the position **FAN OVEN** and for another 15 minutes in the **GRILL** mode in order to eliminate any traces of grease from the electrical resistances.

Operating principles

Heating and cooking in the FAN oven are obtained in the following ways:

a. by forced convection

A fan sucks in the air contained in the oven muffle, which sends it through the circular heating element and then sends it back through the muffle. Before the hot air is sucked back again by the fan to repeat the described cycle, it envelops the food in the oven, provoking a complete and rapid cooking.

It is possible to cook several dishes simultaneously.

b. by radiation

The heat is irradiated by the infra red grill element.

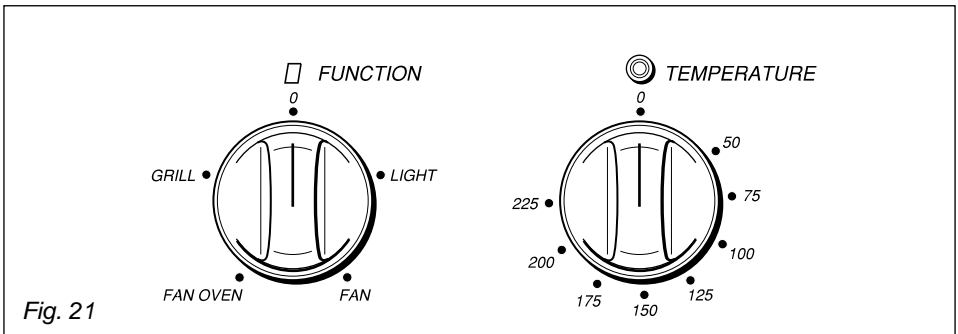
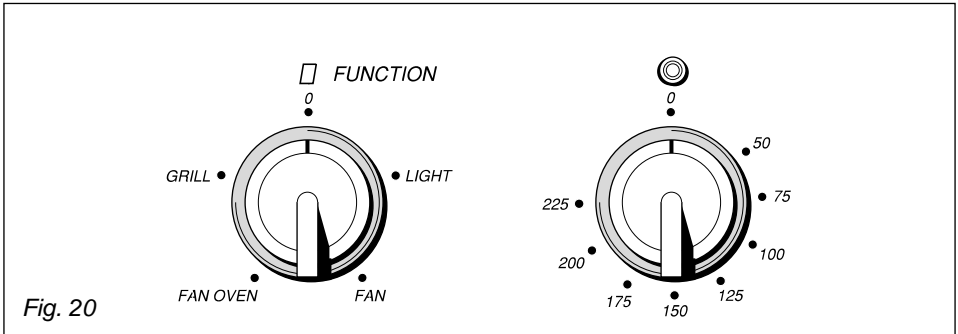

Electric Fan Oven

B. Function Selector

Cook or grill by turning the knob until the indicator on it is in line with the function required.

LIGHT The oven light is switched on.

FAN The fan switches on. This function can be used for defrosting food.

FAN OVEN Use in conjunction with the temperature selector C.

GRILL Grill with the door closed. Set the function selector B to the grill position and the temperature selector C to the desired temperature till to max. **200°C**. The temperature can be varied depending on the food being cooked. Before using the grill, pre-heat for about five minutes. Position the grill pan on the highest shelf position and check continually as the food could easily burn.

Note: it is recommended that you do not grill for longer than 30 minutes at any one time.

Attention: the oven door becomes very hot during operation.

Keep children away.

C. Temperature Selector

The light above this dial will illuminate when the oven is switched on and turns off when the oven reaches the correct temperature.

The light will cycle on and off during cooking in line with the oven temperature.

Cooking advice

Sterilization

Sterilization of foods to be conserved, in full and hermetically sealed jars, is done in the following way:

- Set the switch to position **FAN OVEN**
- Set the thermostat knob to position 185 °C and preheat the oven.
- Fill the dripping pan with hot water.
- Set the jars onto the dripping pan making sure they do not touch each other and the door and set the thermostat knob to position 135 °C.

When sterilization has begun, that is, when the contents of the jars start to bubble, turn off the oven and let cool.

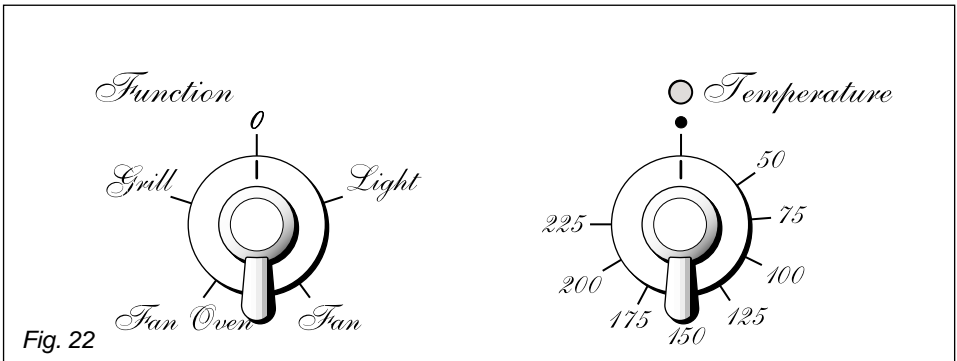

Fig. 22

Electric Fan Oven

Regeneration

Set the switch to position **FAN OVEN** and the thermostat knob to position 150° C.

Bread becomes fragrant again if wet with a few drops of water and put into the oven for about 10 minutes at the highest temperature.

Roasting

To obtain classical roasting, it is necessary to remember:

- that it is advisable to maintain a temperature between 180 and 200 °C.
- that the cooking time depends on the quantity and the type of foods.

Simultaneous cooking of different foods

The **FAN** consents a simultaneous heterogeneous cooking of different foods. Different foods such as fish, cake and meat can be cooked together without mixing the smells and flavors together. This is possible since the fats and vapors are oxidized while passing through the electrical element and therefore are not deposited onto the foods.

The only precaution to follow are:

- The cooking temperatures of the different foods must be as close to as possible, with a maximum difference of 20° - 25 °C.
- The introduction of the different dishes in the oven must be done at different times in relation to the cooking times of each one.

The time and energy saved with this type of cooking is obvious.

Electrical grill

The electrical grill is made up of an electrical element which, becoming red hot, generates infra red rays which permit grill cooking (input 2500 W).

Use of the grill

Switch the grill on, setting the two knobs:

- Function selector to **GRILL** position.
- Thermostat selector to position **200°C max.**

Leave to warm up for approximately 5 minutes with the door **closed**.

Place the food inside positioning the rack as near as possible to the grill.

Insert the drip pan under the rack to collect the cooking juices.

Grilling with the oven door closed.

Grilling with the oven door closed and do not for longer than 30 minutes at any one time.

Attention: the oven door becomes very hot during operation. Keep children away.

Electric Fan Oven

Grease Filter

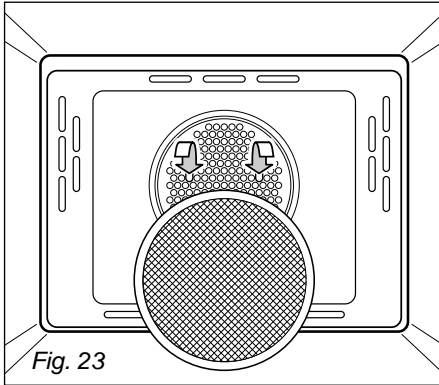

A special screen is provided at the back of the fan oven to catch grease particles, mainly when meat is being roasted. When baking pastry etc, the filter should be removed.

Always clean the filter after cooking as any solid residues on it might adversely affect the oven performance.

The inside of the oven can be easily cleaned with a wet cloth and oven cleaner.

As a safety measure, before you start cleaning the oven, make sure the electrical supply is switched off.

You should clean the oven when it is cold.

Do not leave acid or alkaline residues (lemon juice, vinegar, salt, tomato, etc) on the enamelled surfaces.

Avoid abrasive cleaning products on the painted parts.

60' Alarm

F. Manual timer - 60'

The minute counter is a timed acoustic warning device which can be set for a maximum of 60 minutes.

The knob (Fig. 24) must be rotated clockwise as far as the 60 minute position and then set to the required time by rotating it anticlockwise.

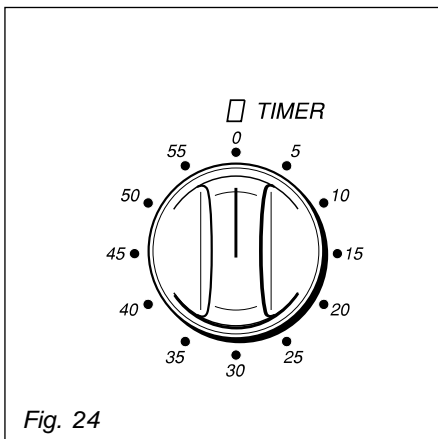

120' Cut-off Timer

G. Cut-off timer - 120' (Fig. 25)

The function of the timer runs the oven for a preset time.

1) Starting up.

After setting the function selector and thermostat to the required mode and temperature, rotate the timer knob clockwise until you reach the required cooking time (max 120 minutes).

Once this time has elapsed, the timer will return to the "0" position and the oven will automatically switch off.

2) Manual position.

If the cooking time is longer than two hours or if you wish to use the oven manually, switching it off as required, the knob must be turned to position  .

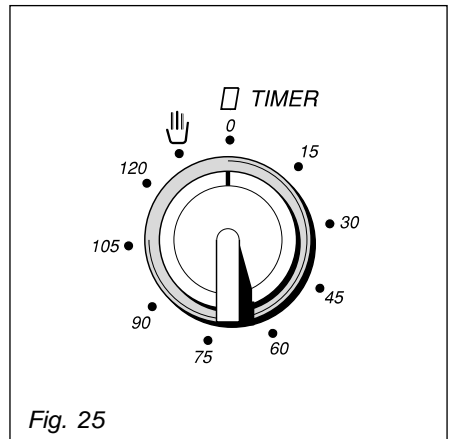

Electronic timer



H. Electronic timer (end cooking)

The electronic programmer is a device with the following functions:

- 24 hours clock with illuminated display
- Timing of oven cooking with automatic switch-off (max. 99 minutes).

ELECTRONIC CLOCK

Upon immediate connection of the oven or after a mains failure, three zeros will flash on the programmer panel.

To set the clock it is necessary to push the  button and then, within 7 seconds, the  or  button until you have set the correct time.

The clock will show zero after a mains failure.

Attention: When the programmer display shows three flashing zeros the oven cannot be switched on.





The oven can be switched on when the symbol  is shown in the display.

SETTING THE FREQUENCY OF THE ALARM SOUND



The selection from 3 possibilities of sound can be made by pressing the  button.

COOKING WITH AUTOMATIC SWITCH-OFF

The aim of this function is to automatically stop the cooking after a pre programmed time, for a maximum period of 99 minutes.



To set the cooking time, push the  or  button until you obtain the desired time in the display. The symbol AUTO will be shown in the display. Then you adjust the oven thermostat knob according to the required temperature. The oven will immediately start to operate and will work for the pre programmed time. The display shows the count down. Clock time can be displayed by pressing the  button. Once the time has elapsed, the oven will switch off automatically, the symbol AUTO will go off and an intermittent buzzer, lasting 7 minutes, will start; this can be stopped by pressing the  button.

Important: Before the buzzer is stopped switch off the oven manually.

To cancel the cooking program at any time press the  and  buttons together and release the  button first.

ELECTRONIC ALARM

The programmer can be used as an alarm only for a maximum period of 99 minutes.

To set the alarm, push the  or  button until you obtain the desired time in the display. Once the time has elapsed, an intermittent buzzer, lasting 7 minutes, will start; this can be stopped by pressing the  button.

Attention: If the bottom oven is switched on when the buzzer starts, it will be automatically switched off.

For it to operate furtherly you have to stop the buzzer by pressing the  button.

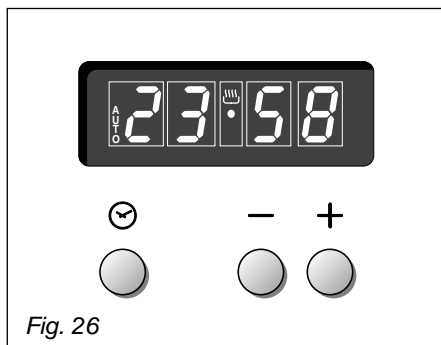

Fig. 26

Electronic programmer

A. Autotimer

The electronic programmer is a device which groups together the following functions:

- 24 hours clock with illuminated display
- Timer (up to 23 hours and 59 minutes)
- Program for automatic oven cooking
- Program for semi-automatic oven cooking.

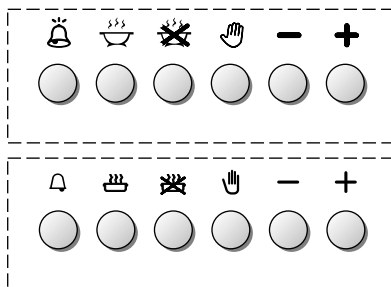

Description of the buttons:











-  Timer
-  Cooking time
-  End of cooking time
-  Manual position and cancellation of programmed cooking
-  Advancement of the numbers of all programs
-  Turning back of the numbers of all programs and changing the frequency of the audible signal.

Fig. 27

Description of the lighted symbols:

AUTO - *flashing* - Programmer in automatic position but not programmed
AUTO - *always lighted* - Programmer in automatic position with program inserted.

-  Automatic cooking taking place
-  Timer in operation
-  and **AUTO** - *flashing* - Program error.
(The time of day lies between the calculated cooking start and end time).



NOTE: Select a function using the respective button and, in 5 seconds, set the required time with the  /  buttons ("one-hand" operation).

A power-cut makes the clock go to zero and cancels the set programs.

Electronic Clock

The programmer is equipped with an electronic clock with lighted numbers which indicates hours and minutes.

Upon immediate connection of the oven or after a power-cut, three zeros will flash on the programmer panel.



To set the hour it is necessary to push the  button and then the  or  button until you have set the exact hour.

In another way push simultaneously the   two buttons and at the same time push the  or  button.

NOTE: The hour setting after programming delete any program.

Electronic programmer

Normal Cooking without the use of the Programmer

To manually use the oven, that is, without the aid of the programmer, it is necessary to cancel the flashing **AUTO** by pushing the button  (**AUTO** will be switched off and the symbol  will go on).





Attention: If the **AUTO** is steady lighted (which means a cooking program has already been inserted), by pushing the button  you will cancel the program and revert to manual operation.



If the oven is switched on, remember you must switch off manually.

Electronic Timer

The timer program consists only of a buzzer which may be set for a maximum period of 23 hours and 59 minutes.

If the **AUTO** is flashing push the  button.

To set the time, push the  button and the  or  until you obtain the desired time in the panel (fig. 8). Having finished the setting, the clock hour will appear on the panel and the  symbol will be lighted.

The countdown will start immediately and may be seen at any moment on the panel by simply pressing the button . At the end of the time, the  symbol will be switched off and an intermittent buzzer will sound; this can be stopped by pressing one of any of the buttons.

Setting the frequency of the Audible Signal







The selection from 3 possibilities of sound can be made by pressing the  button. The last setting remains on.

Setting the Automatic Oven Cooking

To cook food automatically in the oven, it is necessary to:

1. Set the length of the cooking time
2. Set the end of the cooking time
3. Set the temperature and the oven cooking program.

These operations are done in the following way:

1. Set the length of the cooking time by pushing the  button and the  button to advance, or  to go back if you have passed the desired time. The **AUTO** and the  symbol will be on.
2. Set the end of the cooking time by pressing the  button (the cooking time already added to the clock time will appear), and the  button; if you pass the desired time you may get back by pushing the  button.

After this setting, the  symbol will go off. If after this setting, the **AUTO** flashes on the panel and a buzzer sounds, it means there was an error in the programming, that is that the cooking cycle has been superimposed on the clock. In this case, modify the end of cooking time or the cooking time itself by following again the above mentioned instructions.

Electronic programmer

3. Set the temperature and the cooking program by using the switch and thermostat knobs of the oven (see specific chapters).

Now the oven is programmed and everything will work automatically, that is the oven will turn on at the right moment and end the cooking at the selected time.

During cooking, the  symbol remains on.

By pushing the  button you can see the time that remains until the end of cooking.

The cooking program may be cancelled at any moment by pushing .



At the end of the cooking time the oven will turn off automatically, the  symbol will turn off, **AUTO** will flash and a buzzer will sound, which can be turned off by pushing any of the buttons.

Turn the switch and thermostat knobs to zero and put the programmer onto “manual” by pressing the  button.



Attention: A power-cut makes the clock go to zero and cancels the set programs. After a power-cut, three zeros will flash on the panel.

Setting the Semi-Automatic Oven Cooking

This is used to switch automatically off the oven after the desired cooking time has elapsed. To effect the semi-automatic cooking there are two ways:

1. Set the length of the cooking time by pushing the  button and the  button to advance, or  to go backwards if you have passed the desired time.



or



2. Set the end of the cooking time by pushing the  button and the  button to advance, or  to go backwards if you have passed the desired time.

AUTO and the  symbol will be on.

Then set the temperature and the cooking program using the oven switch and thermostat knobs (see specific chapters).

The oven is switched on and it will be switched off automatically at the end of the desired time.

During cooking, the  symbol remains on and by pressing the button  you can see the time that remains till the end of the cooking. **The cooking program**

can be cancelled at any moment by pushing the  button. At the end of the cooking, the oven and the  symbol will turn off, the **AUTO** will flash and a buzzer will sound; that can be stopped by pushing any of the buttons. Turn the switch and thermostat knobs to zero and set the programmer onto “manual” by pressing the  button.

Analogical programmer

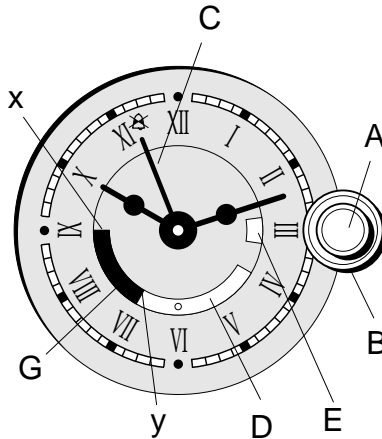

Fig. 28

Autotimer

This device comprises the following functions:

- Electric clock
- Minute counter with acoustic signal (up to 55 minutes)
- Automatic cooking program (programming of end of cooking time and cooking duration)
- Semi-automatic cooking program (immediate start of cooking and programmed end of cooking period).

Electric clock (Fig. 28)

To set the time, rotate the small knob (A) clockwise or anticlockwise exerting a slight pressure.

Minute counter

The minute counter function consists simply of an acoustic signal which sounds once the set time has elapsed.

To set the minute counter, rotate the small knob (A) clockwise or anticlockwise (without pressing it) until the hand (C) coincides with the required time (max 55 minutes).

Countdown will begin immediately and the hand (C) will begin to turn anticlockwise, always showing the remaining time.

Once the set time has elapsed the acoustic signal will sound until the hand (C) is turned to the symbol ⚡ by rotating the knob (A) anticlockwise.

Analogical programmer

Excluding the programmer

To use the oven manually the programmer must be excluded by turning the larger outer knob (B, Fig. 28) clockwise until the symbol  appears in the window (E, Fig. 28).

Programmer

The semicircular programming window (D) rotates clockwise, operated by the larger outer knob (B).

The end (x) of the semicircular window (D) is the end of cooking indicator.

The end (y) of the red sector (G), which can be seen by rotating the knob (B) anticlockwise, is the beginning of cooking indicator.

The red section (G) shows the cooking time.

When "0" appears in the window (E) this indicates that cooking is finished.

Automatic cooking (Fig. 8)

If you wish the oven to switch on and off automatically:

1. Set the end of cooking time within a 12 hour range
2. Set the beginning of cooking time (end of cooking time minus cooking time)
3. Set the oven function and temperature.

These operations are carried out as follows:

1. Set the end of cooking time by turning the larger outer knob (B) clockwise until the end (x) of the semicircular window (D) coincides with the required time.

If you go beyond the required time, you must repeat the whole cycle as it is not possible to scroll in reverse.

2. Set the beginning of cooking time by rotating the larger knob (B) anticlockwise until the end (y) of the red sector (G) coincides with the required time.

The red sector (G) indicates the cooking time (max 3 hours 45 minutes) and therefore the period the oven remains on.

As the cooking time elapses the red sector will rotate together with the clock hand.

3. Set the required cooking function and temperature via the function selector and thermostat knob.

The oven is now programmed and everything will work automatically.

Referring to the example in Figure 28:

- the oven will come on at 7.00 (end x of the red sector G)
- cooking duration 2 hours
- end of cooking at 9.00 - oven will switch off and the "0" will appear in the window (E).

When the "0" appears in the window (E) this means that cooking has finished; zero the function selector and thermostat knob and reset the programmer to manual by rotating the larger outer knob (B) clockwise until the symbol  appears in the window (E).

Analogical programmer

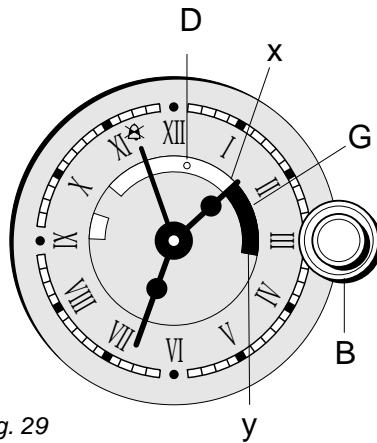

Fig. 29

Semi-automatic cooking (Fig. 8)

This automatically switches the oven off at the required time. To do this, follow the instructions below:

1. Set the end of cooking time by rotating the larger outer knob (B) clockwise until the end (x) of the semicircular window (D) coincides with the required time.
2. Rotate the larger outer knob (B) anti-clockwise until it stops at the hour hand.
3. Set the required cooking function and temperature via the function selector and thermostat knob.

The oven will begin to work immediately and will switch off automatically at the set time. Zero the oven knobs and reset the programmer to manual.

Cleaning and Maintenance

General advice

It is advisable to clean when the appliance is cold and especially for cleaning the enamelled parts.

Avoid leaving alkaline or acidic substances (lemon juice, vinegar, etc.) on the surfaces. Avoid using cleaning products with a chlorine or acidic base.

The ovens must always be cleaned after every use, using suitable products and keeping in mind that its operation for 30 minutes on the highest temperature eliminates most grime reducing it to ashes.

Oven doors

The internal glasses of the oven doors can be easily removed for cleaning by unscrewing the two fixing screws (figure 30).

Stainless steel surfaces

CAUTION

The stainless steel used in this oven is protected with a Special Lacquer to reduce finger-print marks.

To avoid damaging this lacquer, do not clean the stainless steel with abrasive cleaners or abrasive cloths or scouring pads.

ONLY SOAP/WARM WATER MUST BE USED TO CLEAN THE STAINLESS STEEL SURFACES.

Substitution of the oven light

The light bulb must be a type resistant to high temperatures (300° C).

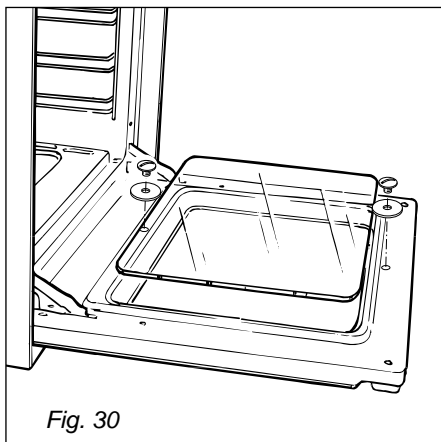

Fig. 30

Important:

Before any operation of cleaning and maintenance disconnect the appliance from the electrical network.

Do not use a steam cleaner because the moisture can get into the appliance thus make it unsafe.

Helpful Advice

Trouble shooting

Problem

Food too brown but not cooked.

Remedy

Turn down the oven temperature slightly and cook a little longer

Problem

Food cooked but not brown enough.

Remedy

Increase temperature.

Problem

Food baking unevenly.

Remedy

1. The temperature may be slightly high turn it down
2. Position the food in the centre of the shelves rather than towards the sides of the oven.
3. Rotate the food a half turn in the oven.
4. Try pre-heating the oven for 5-15 minutes prior to baking.

Always remove cooked items as soon as they are ready and continue cooking the under-cooked items until they are completely finished.

Changing the Oven Cavity Light Bulb.

If the oven light falls:

1. Turn off the oven by switching the oven selector to 0, switch off at the cooker point.

2. When the oven is cool, reach back and upwards inside the oven, the bulb is in the top left corner.
3. Unscrew the light glass cover, replace the bulb with a new one of the same specification and screw the cover back until it is hand tight.

NOTE: Oven bulb replacement is not covered by your guarantee.

Other bulbs cannot be changed by yourself and should be replaced by an authorised CAPLE Service Engineer. Bulbs other than the oven bulb are covered by the guarantee.

IMPORTANT: Ovens get hot. Keep children away from this appliance at all times.

If Your Oven Does Not Work

Before calling a CAPLE service engineer run through the following checklist.

- The oven is connected to the power supply and that the fuse is intact.

If you are in any doubt about carrying out these checks, call the **CAPLE Helpline on 0870 241 1142.**

A charge will be made if the appliance is found to be in working order, or if it has not been installed in accordance with these instructions, or if it has been used incorrectly.

Recommended cooking temperature

Food	°C	°F	Gas Mark	Shelf Position*	Cooking Time (approx)
CAKES					
Victoria sandwich	190	375	5	2 or 3	20-25 mins
Small cakes/buns	190	375	5	1 and 2	15-20 mins
Maidera cake	180	350	4	2 or 3	20 mins
Fruit cake	170	325	3	3	1¾ hours
Rich fruit cake	150	300	2	3 or 4	2½ hours
Scones	225	425	8-9	2	8-10 mins
PASTRY					
Puff	225	425	8-9	2	10-20 mins
Short crust	200	400	6	2	20-30 mins
Plate tarts	200-210	400-410	6	1 or 2	30-35 mins
Quiches and flans	200-210	400-410	6	1 or 2	40-45 mins
YEAST					
Bread loaf	225	425	7-8	2	35-55 mins
Bread rolls	220	425	7	1 or 2	15-20 mins
Pizza dough	230	450	8	2	20 mins
ROAST MEAT					
Beef – Medium	190	375	5	2 or 3	20 mins/lb + 20 mins
Lamb	190	375	5	2 or 3	25-30 mins/b + 25 mins
Pork	190-200	375-400	5-7	2 or 3	30 mins/lb + 30 mins
Veal	190	375	5	2 or 3	30 mins/b + 30 mins
Chicken	190	375	5	2 or 3	30 mins/b + 30 mins
Turkey up to 10lb	180	350	4	2 or 3	18-20 mins/b + 20 mins
Stews/casseroles	150-170	300-325	2-3	2 or 3	1½ 2 hours

N.B. For fan ovens reduce the temperature by 10-20°C. For any dish taking one hour or over to cook, reduce the cooking time by 10 minutes per hour.

* Shelf positions have been counted from the top of the oven to the base. A fan oven creates more even temperature throughout, therefore the shelf positions are not as critical.

CAPLE "Built-in" Service

Should you require service at any time, please contact the **Caple Helpline on 0870 241 1142.**

Caple have a nationwide service network of engineers who will respond quickly to your call.

Always replace spare parts with genuine **Caple** spares. These are available from authorised **Caple Service Centres** or by mail order from our **National Service Stores, simply telephone 0870 241 1142.**

When ordering parts always quote the model number and serial number of your appliance.

YOUR GUARANTEE

CAPLE guarantees all parts of this product for one year from the date of purchase. During that time, should it become necessary CAPLE engineers will replace or repair all defective parts free of charge, except for parts subject to fair wear and tear, such as lightbulbs.

Parts and the engineers labour costs are chargeable after the first 12 months.

To qualify for benefits under the guarantee, you must be able to provide proof of date of purchase and the appliance must have been supplied, installed and used for domestic purposes only in accordance with CAPLE instructions.

Consequential losses and accidental damage to the product are not covered by the guarantee.

This guarantee does not affect your statutory or common law rights.

CAPLE cannot be responsible for the results of using this appliance for any other purposes other than those described in these instructions.