



Integrated Washing Machine Instruction Manual

WMI4001



Contact Caple on 0117 938 7420 for spare parts or www.caple.co.uk

CONTENTS

Warnings	3
Environmental Protection	8
Warranty	8
Product Overview	9
Installation	10
Built In Installation	12
Operation	14
Quick User Guide	17
Control Panel	18
Washing Programmes	26
Table Of Programmes	28
Cleaning And Maintenance	30
Troubleshooting	32
Care Symbols	35
Caple Contact Details	36

WARNINGS

- If the supply cord is damaged, it must be replaced by the manufacturer, its service agent or similarly qualified persons in order to avoid a hazard.
- The new hose-sets supplied with the appliance are to be used and old hose-sets should not be reused.
- This washing machine is for indoor use only.
- This appliance can be used by children aged from 8 years and above and persons with reduced physical, sensory or mental capabilities or lack of experience and knowledge if they have been given supervision or instruction concerning use of the appliance in a safe way and understand the hazards involved.
- Children shall not play with the appliance. Cleaning and user maintenance shall not be made by children without supervision.
- Children should be supervised to ensure that they do not play with the appliance.
- Children of less than 3 years should be kept away unless continuously supervised.
- If the supply cord is damaged, it must be replaced by a special cord or assembly available from the manufacturer or its service agent.
- Only use the hose-sets supplied with the appliance for the water supply connection (do not reuse old hose-sets).

- Water pressure must be between 0.05 MPa and 0.8 MPa.
- Make sure carpets or rugs do not obstruct the base or any of the ventilation openings.
- After installation, the appliance must be positioned so that the plug is accessible.
- The maximum load capacity of dry clothes depends on the model used (see control panel).
- To consult the product technical specification please refer to the manufacturer website.
- This appliance is not intended for use by persons (including children) with reduced physical, sensory or mental capabilities, or lack of experience and knowledge, unless they have been given supervision or instruction concerning use of the appliance by a person responsible for their safety.
- Pull out its plug from the power socket and turn off the water tap before cleaning or maintenance.
- Make sure that all pockets are emptied.
- Sharp and rigid items such as coins, nails, screws or stone etc may cause serious damages to this machine.
- Pull out its plug and cut off water supply after the operation.
- Please check whether the water inside the drum has been drained before opening its door. Please do not open the door if there is any water visible.

- Pets and children may climb into the machine. Check the machine before every operation.
- Take care that power voltage and frequency shall be identical to those of washing machine.
- Do not use any socket with rated current less than that of washing machine.
- Never pull out power plug with wet hands.
- Do not pull on the power cord or appliance to unplug the machine.
- To ensure your safety, the power cord plug must be inserted into an earthed three-pole socket. Check carefully and make sure that your socket is properly and reliably earthed.
- Packing materials may be dangerous to children. Please keep all packing materials (plastic bags, foams etc) far away.
- Washing machines shall not be installed in bathrooms or wet rooms as well as in the rooms with explosive or caustic gases.
- The water and electrical connections must be connected by a qualified engineer in accordance with the manufacturer's instructions and local safety regulations.
- Before operating this machine, all packages and transport bolts must be removed. Otherwise the washing machine may be seriously damaged while washing the clothes.

- This appliance is intended to be used in household and similar applications such as:
 - › Staff kitchen areas in shops, offices and other working environments.
 - › Farm Houses.
 - › By clients in hotels, motels and other residential type environments.
 - › Bed and breakfast type environments.
- Before using the machine for the first time, the washing machine shall be operated in one round of the whole procedures without clothes inside.
- Your washing machine is only for home use and is only designed for the textiles suitable for machine washing.
- Flammable and explosive or toxic solvents are forbidden. Gasoline and alcohol etc shall not be used as detergents. Please only select the detergents suitable for machine washing.
- Do not wash carpets in this washing machine.
- Be careful of burning when washing machine drains hot washing water.
- Never refill the water by hand during washing.
- Please remember to disconnect water and power supply immediately after the clothes are washed.
- Do not climb up and sit on top cover of the machine.
- Do not lean against machine door.

- Please do not close the door with excessive force. If it is found difficult to close the door, please check if the excessive clothes are put in or distributed well.
- Transport bolts shall be reinstalled to the machine by a competent person.
- The accumulated water shall be drained out of the machine.
- Handle the machine carefully. Never hold any protruded part on the machine while lifting. Machine door cannot be used as the handle during the conveyance. During transport, never rest the door on the trolley. Two people are recommended to lift the washing machine.
- Do not expose the washing machine to rain, direct sunlight or other weather elements. Protect from possible freezing.
- The use of converters, multiple sockets or extension cords is strongly advised against.
- In the event of fault and / or malfunction, turn off the washing machine, close the water tap and do not tamper with the appliance. Immediately contact Caple service and only use original spare parts. Failure to observe these instructions may jeopardise appliance safety.



WARNING: Water may reach very high temperatures during the wash cycle.



ENVIRONMENTAL PROTECTION

Waste electrical products should not be disposed of with household waste. Please recycle where facilities exist. Check with your Local Authority or retailer for recycling advice. This appliance is marked according to the European Directive on Waste Electrical and Electronic Equipment (WEEE).

By ensuring this product is disposed of correctly, you will help prevent potential negative consequences for the environment and human health, which could otherwise be caused by inappropriate waste handling of this product. The symbol on the product indicates that this product may not be treated as household waste. Instead it shall be handed over to the applicable collection point for the recycling of electrical and electronic equipment. Disposal must be carried out in accordance with local environmental regulations for waste disposal.

For more detailed information about treatment, recovery and recycling of this product, please contact your local council, your household waste disposal service or the retailer where you purchased the product.

CE DECLARATIONS OF CONFORMITY

This appliance has been manufactured to the strictest standards and complies with all applicable legislation, Low Voltage Directive (LVD) and Electromagnetic Compatibility (EMC).

UKCA DECLARATIONS OF CONFORMITY

This appliance has been manufactured to the strictest standards and complies with all applicable legislation.

TECHNICAL FICHE

This appliance conforms to all current and applicable energy regulations. To view the Technical Fiche that supports the energy labelling data, please visit the product page on our website www.caple.co.uk

WARRANTY

Your new appliance is covered by warranty. The warranty card is enclosed - if it is missing, you must provide the following information to your retailer in order to receive a replacement: date of purchase, model and serial number (placed on the inside of the appliance storage drawer). Registration can also be completed online by visiting www.caple.co.uk.

Ensure you keep your warranty card safe, you may need to show it to Caple Service together with proof of purchase.

If you fail to show your warranty card you will incur all repair charges.

Spare parts are only available from Caple Service and spare parts authorised centres.

PRODUCT OVERVIEW

COMPONENT

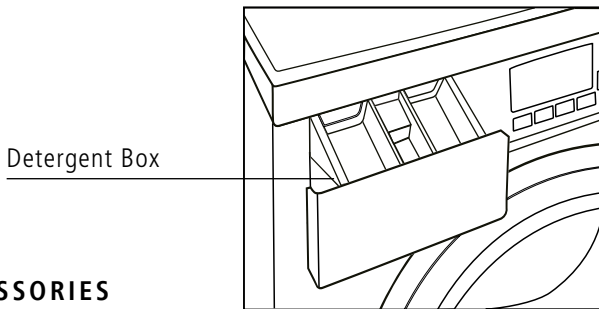
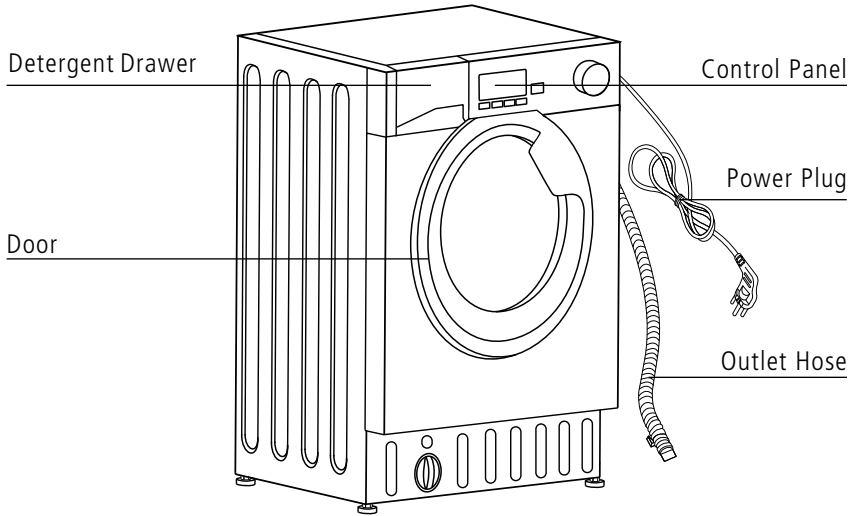

ACCESSORIES

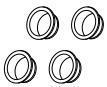

Transport hole plug



Inlet pipe



Corrugated sound proofing sheet

INSTALLATION

UNPACKING THE WASHING MACHINE

Unpack your washing machine and check if there is any damage during the transportation. Also make sure that all the items (as shown on page 9) in the attached bag are received. If there is any damage to the washing machine during the transportation, or any item is missing, please contact your retailer immediately.

DISPOSE OF THE PACKING MATERIALS



WARNING:

Keep packaging materials away from children.

The packing materials of this machine may be dangerous to children. Please dispose of them properly. Please dispose of the related packing materials according to the relevant local regulations. Please do not throw the packing materials away together with the other daily living disposals.

REMOVE TRANSPORT BOLTS

Before using this washing machine, transport bolts must be removed from the backside of this machine. Please take the following steps to remove the bolts:

1. Loosen all bolts with spanner and then remove along with the flat washers, rubber bungs and plastic spacer tubes.
2. Cover the open transportation bolt holes with the plastic cap included in the instruction bag.
3. Keep the transport bolts, flat washers, rubber bungs and plastic spacer tubes stored away safely for future use.

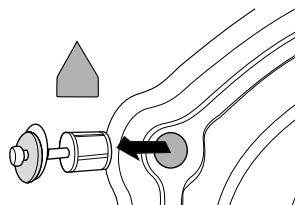

NOTE:

During the removal of the bolts, spacer tubes fall inside the product. These can be removed by tilting the product forward and recovering them from the floor or inside the base of the machine.

SOUNDPROOFING SHEET

Place the corrugated sound-proofing sheet, found on top of the appliance during the unpacking process, into the base of the appliance as shown.

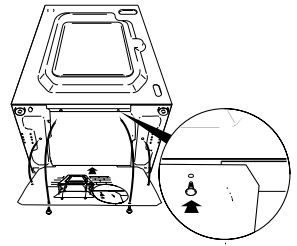

CONNECT INLET PIPE

Connect the inlet pipe to the water supply tap only using the pipe supplied with the appliance (do not reuse old pipe-sets).

The washing machine should be installed in its final position such that the inlet pipe is not kinked or trapped.

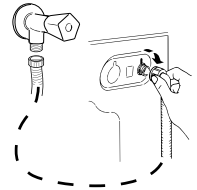

INSTALL DRAIN HOSE

The corrugated drain hose should be inserted into suitable drain pipe of between 50cm and 85cm height above the floor using the curved drain hose support. If an under sink connection is used the drain hose must be routed above the sink overflow opening to prevent back siphoning. Care must be taken to avoid kinking or trapping the drain hose.

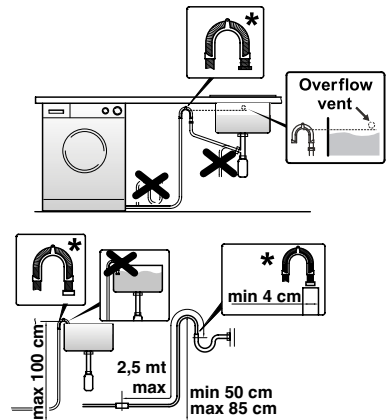

ADJUST LEGS

Level the appliance using the feet:

1. Turn the nut clockwise to release the screw.
2. Rotate the foot to raise or lower it until it touches to the floor.
3. Lock the foot, screwing in the nut, until it tightens against to the bottom of the washing machine.
Plug in the appliance.

*** ACCESSORY SOLD SEPARATELY**

WARNING:

Contact Caple Service should the power cord need replacement. Installation faults are not covered by the manufacturers warranty.

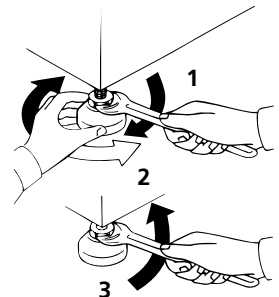

BUILT IN INSTALLATION

Position the template onto the reverse of the furniture door. It is possible to mount the hinges and closure magnet on the right or left-hand side depending on your requirements. Mark the screw hole positions, then drill out these positions.

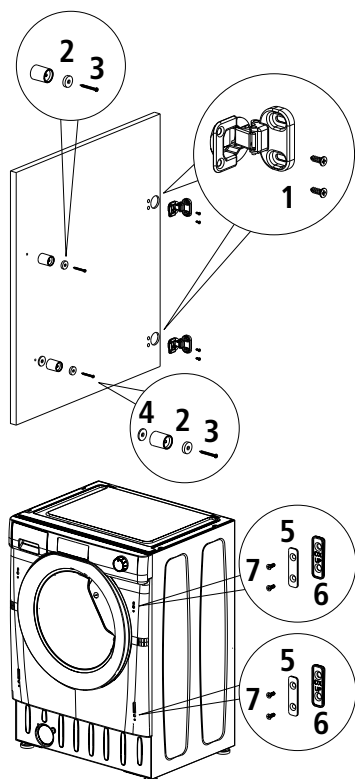
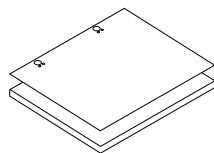

- > Fix the hinges in place with the 4 screws provided (1)
- > Fix the magnet (2) in place using a screw (3)
- > If necessary, use the gasket (4) to adjust and achieve the appropriate assembly (down side)
- > Mount the plate (5) on the right or left-hand side, depending on your installation requirements.
- > Place the plastic support (6) under the plate and fix it in position with screw (7)

NOTE:

Hinges are to be fixed to the door by hand only. Do not use a power tool/electric drill as this will prevent the possibility of damaging the threads.

Mount the furniture door to the front of the washing machine using the hinges. Fix the spacers (1) in place with the 2 screws (2) and then fix the hinges with 2 screws (3).

NOTE:

We suggest mounting the furniture door so that it opens towards the left, which is the same direction as the porthole door. This will leave more space when you are loading washing into the appliance.

Hinges are to be fixed to the door by hand only. Do not use a power tool/electric drill as this will prevent the possibly of damaging the threads.

Slide the washer into an opening of the size indicated in the diagram opposite. A furniture plinth may be run across the front of the appliance, but its height will be dictated by the height the washer is set at. Position the outlet hose properly so that the floor will not be damaged by water leakage.

The 4 adjustable feet allow the height of the washer to be adjusted from 820mm to a maximum of 840mm. To adjust the height, you should remove the nuts fitted to each foot and replace these with the 5mm nuts supplied. Raise the feet to your desired height and then fully tighten the lock nut to the base of the washer.

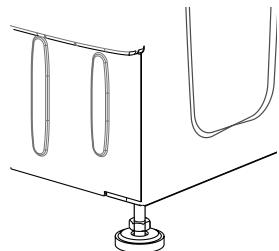
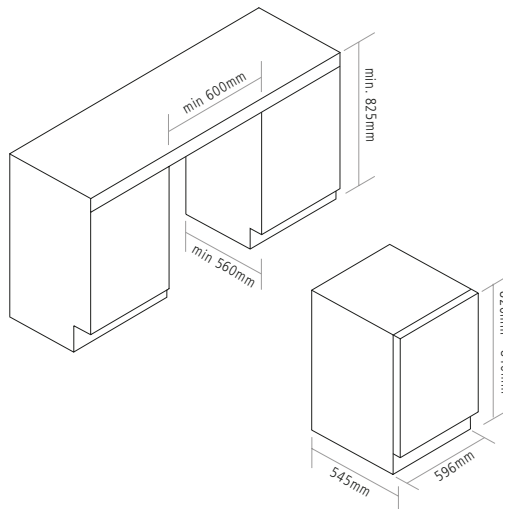
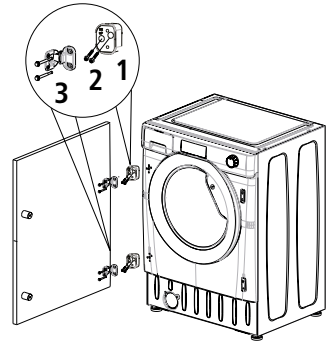

OPERATION

EMPTY ALL POCKETS

Foreign objects (e.g. nails, coins, paper, clips, etc.) can cause damage to garments and to the components in the machine.

Check the laundry before washing and remove foreign objects.

SORT THE LAUNDRY

Sort the laundry by colour and care label. Most garments have a textile care label in the collar or side seam.

TIP:

Dark textiles often contain excess dye and should be washed separately several times before being included in a mixed load. Always wash whites and colours separately.

PRE-TREAT STAINS

Badly soiled areas, stains etc. should be cleaned as soon as possible, preferably whilst still fresh. Spillages should be carefully dabbed off using a soft, colour fast cloth. Do not rub.

TIP:

Badly soiled areas can be pretreated with a liquid detergent, stain removers etc. first, following the manufacturer's instructions. With particularly stubborn stains ask your dry cleaner for advice.

Solvent-based cleaners (e.g. benzine) can damage plastic parts. When pre-treating garments, make sure that any plastic parts (e.g. buttons) are protected from cleaning agent.

Chemical (solvent-based) cleaning agents can cause severe damage to the washing machine. Do not use solvent-based cleaning agents in the machine.

GENERAL TIPS:

Curtains: Remove lead weights first or place in a laundry bag

Underwiring and collar stiffeners: Any loose wiring in bras, shirt collar stiffeners, etc. should be removed or sewn in.

Close any zips, attach Velcro fasteners, fasten hooks and eyes etc. before washing.

Fasten duvet covers, pillow cases etc. to prevent small items from being rolled up inside them.

When washing rugs, bed covers or other heavy clothing, it is recommended to avoid the spinning cycle.

Do not wash any items in this washing machine which are specified by the manufacture as not washable on the care label ( symbol).

HELPFUL SUGGESTIONS:

MAXIMISE THE LOAD SIZE

Achieve the best use of energy, water, detergent and time by using the recommended maximum load size. Save up to 50% energy by washing a full load instead of 2 half loads.

DO YOU NEED TO PRE-WASH?

For heavily soiled laundry only. Save detergent, time, water and between 5 to 15% energy consumption by not selecting Pre-wash for slight to normally soiled laundry.

IS A HOT WASH REQUIRED?

Pre-treat stains with stain remover or soak dried in stains in water before washing to reduce the necessity of a hot wash programme. Save energy by using a low temperature wash programme.

When washing heavily soiled whites, we recommend using cotton programs of 60°C or above and a normal washing powder (heavy duty) that contains bleaching agents that at medium/ high temperatures provide excellent results.

For washes between 40°C and 60°C the type of detergent used needs to be appropriate for the type of fabric and level of soiling.

Normal powders are suitable for "white" or colour fast fabrics with high soiling, while liquid detergents or "colour protecting" powders are suitable for coloured fabrics with light levels of soiling.

DETERGENT DRAWER

The detergent draw is split into 3 compartments as illustrated in figure:

Compartment "1": for prewash detergent.

Compartment "☼": for special additives, softeners, starch fragrances, etc.



WARNING:

Only use liquid products; the washing machine is set to automatically dose additives at each cycle during the last rinse.

Compartment "2": for washing detergent.



WARNING:

Some detergents are not designed for use in the dispenser drawer but are supplied with their own dispenser that is placed in the drum directly.

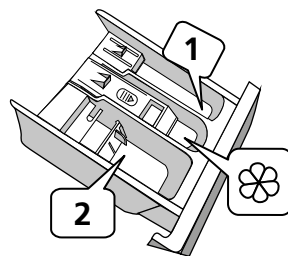

QUICK USER GUIDE

This washing machine automatically adjusts the level of the water to the type and quantity of washing. This system gives a reduction in energy consumption and a saving in washing times.

PROGRAMME SELECTION

- › Turn on the washing machine and select the required programme.
- › Adjust the washing temperature if necessary and press the required “function” buttons.
- › Press the **START/PAUSE** button to start washing.

NOTE:

Should power go out when the washing machine is running, a special memory saves the settings and, when power returns, the machine resumes the cycle from where it left off.

- › At the end of the programme, the message “End” will appear on the display.
- › Wait until the DOOR LOCKED light has gone out before opening the door.
- › Turn off the washing machine.
- › For any type of wash, see the programme table and follow the operating sequence as indicated.

CONTROL PANEL

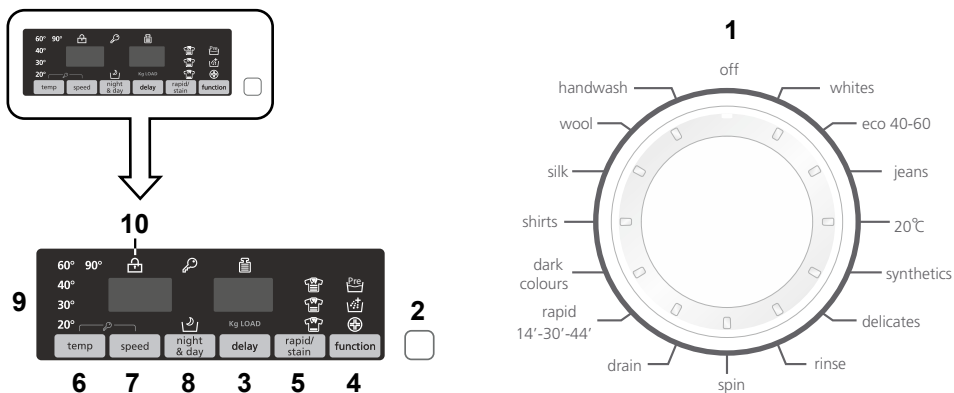

BUTTON	OPERATION
1	Programme Selector With Off Position
2	Start/Pause Button
3	Delay Start Button
4	Function Button
5	Rapid / Stain Level Button
6	Temperature Selection Button
7	Spin Speed Button
8	Night & Day Button
6 + 7	Key Lock
9	Digital Display
10	Door Locked Indicator Light



WARNING:

Do not touch the display while inserting the plug. The machine calibrates the systems during the first few seconds: touching the display could cause the machine to not work properly. In this case, remove the plug and repeat the operation.

OPENING THE DOOR

A special safety device prevents the door from being opened immediately after the end of the cycle. Wait for 2 minutes after the wash cycle has finished and the "Door Security" light has gone out before opening the door.

PROGRAMME SELECTOR WITH OFF POSITION

When the programme selector is turned the display lights up to show the settings for the programme selected. For energy saving, at the end of the cycle or with an inactivity period, the display level contrast will decrease and '5by' will appear in the display. This means the appliance is now in standby mode.

NOTE:

To switch the machine off, turn the programme selector to the **OFF** position.

Press the **START/PAUSE** button to start the selected cycle.

Once a programme is selected the programme selector remains stationary on the selected programme till cycle ends.

"**END**" will appear in the display at the end of the programme and the **DOOR LOCKED** light will go off. It will now be able to open the door.

Switch off the washing machine by turning the selector to **OFF**.

The programme selector must be returned to the **OFF** position at the end of each cycle or when starting a subsequent wash cycle prior to the next programme being selected and started.

START/PAUSE BUTTON

Close the door **BEFORE** selecting the button **START/PAUSE**.

Press to start the selected cycle.

When the **START/PAUSE** button has been pressed, the appliance can take few seconds before it starts working.

PAUSING THE MACHINE

Keep the **START/PAUSE** button pressed for about **2 SECONDS** (some light indicators and the residual time display will flash, showing that the machine is paused).

For safety reasons, in some wash cycle phases, the door can be opened only if the level of the water is below its lower edge and if the temperature is less than 45°C. If these conditions are met, wait for the **DOOR LOCKED** light to switch off before opening the door.

Press the **START/PAUSE** button again to re-start the programme from the point it had been paused at.

CANCELLING THE PROGRAMME

To cancel the programme, set the selector to the **OFF** position.

Wait 2 minutes until the safety device unlocks the door.

DELAY START BUTTON

This button allows you to pre-programme the wash cycle to delay the start of the cycle for up to 24 hours.

To delay the start use the following procedure:

- › Select the required programme.
- › Press the delay start button once to activate it (h00 appears on the display) and then press it again to set a 1 hour delay (h01 appears on the display). The pre-set delay increases by 1 hour each time the button is pressed, until h24 appears on the display, at which point pressing the button again will reset the delay start to zero.
- › Confirm by pressing the **START/PAUSE** button. The delay countdown will begin and when it has finished the programme will start automatically.

It is possible to cancel the delay start by turning the programme selector to **OFF**.

If there is any break in the power supply while the machine is operating, a special memory stores the selected programme and, when the power is restored, it continues where it left **OFF**.

The function buttons should be selected before pressing the **START/PAUSE** button.

FUNCTION BUTTON

This button allows you to choose between three different functions:

PRE-WASHING

This function provides a prewash and is particularly useful for heavily soiled loads.

NOTE:

Only available for some programmes, see Table of Programmes. It is recommended to use only 20% of the suggested quantity shown of the detergent pack.

EXTRA RINSE

This function allows you to add one rinse at the end of the washing cycle and is useful for people with delicate and sensitive skin, for which a small amount of detergent residue can cause irritations or allergies.

It is advisable to also use this function for children's clothes and for washing heavily soiled items, which requires a lot of detergent to be used, or for washing towelling items whose fibres mostly have the tendency to hold the detergent.

HYGIENE +

Activated when you set 60°C of temperature. This function allows deep cleaning of your clothes by maintaining the same temperature for the whole wash.

NOTE:

If an option is selected that is not compatible with the selected programme, the option indicator light will flash then turn off.

RAPID / STAIN LEVEL BUTTON

This button allows you to choose between two different function, depending on the selected programme.

RAPID

This button becomes active when you select the **RAPID (14/30/44 MIN.)** programme on the knob and allows you to select one of the three durations indicated.

STAIN LEVEL BUTTON

Once the programme has been selected the wash time set for that programme will be automatically shown.

This function allows you to choose between 3 levels of wash intensity modifying the length of the programme, depending on how much the fabrics are soiled (can only be used on some programmes as shown in the table of programmes).

TEMPERATURE SELECTION BUTTON

This button allows you to change the temperature of the wash cycles.

It is not possible to raise the temperature over the maximum allowed for the programme, in order to protect the fabrics.

If you want carry out a cold wash all the indicators must be off.

SPIN SPEED BUTTON

- › By pressing this button, it is possible to reduce the maximum speed, and if you wish, the spin cycle can be cancelled.
- › If the label does not indicate specific information, it is possible to use the maximum spin expected in the programme.
- › To prevent damage to the fabrics, it is not possible to increase the speed over the maximum allowed for the programme.
- › To reactivate the spin cycle press the button until you reach the spin speed you would like to set.
- › It is possible to modify the spin speed without pausing the machine.

An overdosing of detergent can cause excessive foaming. If the appliance detects the presence of excessive foam, it may exclude the spinning phase or extend the duration of the programme and increase water consumption.

The machine is fitted with a special electronic device, which prevents the spin cycle should the load be unbalanced. This reduces the noise and vibration in the machine and so prolongs the life of your machine.

NIGHT & DAY BUTTON

This option reduces the intermediate spin speed to 400rpm, where applicable, increases the water level during rinsing and keeps the laundry immersed in water after the final rinse.

During the phase in which the water is held in the tub, the relevant indicator light blinks to show that the machine is at a standstill.

Deselect the option to end the cycle with a spin dry (which may be reduced or cancelled using the appropriate button).

Due to the electronic control, the water in the intermediate phases is emptied silently, making this option very useful for washing at night.

KEY LOCK

Simultaneously pressing the **TEMPERATURE SELECTION** and **SPIN SPEED** buttons for about **3 SECONDS**, allows you to lock the keys. This way, you can avoid making accidental or unwanted changes if a button on the display is pressed accidentally during a cycle.

The key lock can be simply cancelled by pressing the two buttons simultaneously again or turning off the appliance.

DIGITAL DISPLAY

The displays indicator system allows you to be constantly informed about the status of the machine.

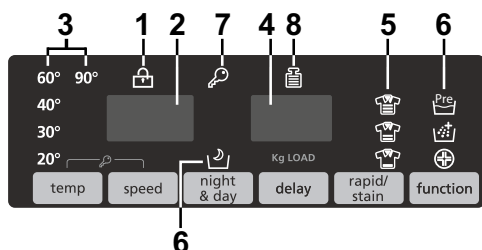

1) DOOR LOCKED INDICATOR LIGHT

The indicator light is illuminated when the door is fully closed.

Close the door before selecting the **START/PAUSE** button.

When **START/PAUSE** is pressed on the machine with the door closed, the indicator will flash momentarily and then illuminate.

If the door is not properly closed, the light will continue to flash for about 7 seconds, after which the start command will be automatically cancelled. In this case, close the door properly and press the **START/PAUSE** button.

A special safety device prevents the door from being opened immediately after the end of the cycle. Wait for **2 MINUTES** after the wash cycle has finished and the **DOOR LOCKED** light has gone out before opening the door. At the end of the cycle turn the programme selector to **OFF**.

2) SPIN SPEED INDICATOR LIGHTS

This shows the spin speed of the selected programme, you can reduce or omit by the relevant button.

3) WASH TEMPERATURE INDICATOR LIGHTS

This shows the washing temperature of the selected programme that can be changed (where allowed) by the relevant button. If you want carry out a cold wash all the indicators must be off.

4) CYCLE DURATION

When a programme is selected the display automatically shows the cycle duration, which can vary, depending on the function selected.

During the initial filling phase of the cycle the machine calculates the actual cycle time needed based on the load size, content and function selected. The real time of the wash will then be displayed. This time can recalculate during the wash depending on detergent levels and load balancing.

5) STAIN LEVEL INDICATOR LIGHTS

Once the programme has been selected, the indicator light will automatically show the stain level set for that programme.

Selecting a different stain level, will light up the relevant indicator.

6) FUNCTION INDICATOR LIGHTS

Can be selected by the relevant button.

7) KEY LOCK INDICATOR LIGHT

The indicator light shows that the keys are locked.

8) KG LOAD

NOTE:

This function is active only on selected programmes.

During the first minutes of the cycle, the “**KG LOAD**” indicator will remain on while the intelligent sensor weighs the laundry and adjusts the cycle time, water and electricity consumption accordingly.

Through every wash phase, “**KG LOAD**” allows you to monitor information on the wash load in the drum. In the first minutes of the wash it:

- › Adjusts the amount of water required.
- › Determines the length of the wash cycle.
- › Controls rinsing according to the type of fabric selected to be washed it.
- › Adjusts the rhythm of drum rotation for the type of fabric being washed.
- › Recognises the presence of too much soap suds, and if necessary, adjust the amount of rinse water.
- › Adjusts the spin speed according to the load, thus avoiding any imbalance.

WASHING PROGRAMMES

To clean different types of fabrics and various levels of dirt, the washing machine has specific programmes to meet every need of washing (see table of programmes).

WHITES

An intensive wash. The final spin at maximum speed gives more efficient removal.

ECO 40-60

The ECO 40-60 programme is able to clean normally soiled cotton laundry declared to be washable at 40°C or 60°C, together in the same cycle. This programme is used to assess the compliance with the EU Ecodesign legislation (environmentally friendly products design).

JEANS

For denim clothing. Darker garments should be washed separately several times before including in a mixed load. Wash denim textiles inside out.

20°C

This innovative programme, allows you to wash different fabrics and colours together, such as cottons, synthetics and mixed fabrics at only 20°C and provides an excellent cleaning performance. Consumption on this programme is about 40% of a conventional 40°C cotton wash.

SYNTHETICS

The washing and rinsing optimise the speed and rhythm of the drum action and water levels. The gentle spin, ensures a reduced formation of creases in the fabric.

DELICATES

This programme has reduced periods of drum rotation during the cycle and is particularly suitable for washing delicate fabrics. The wash cycle and rinses are carried out with a high level of water to ensure the best performance.

RINSE

This programme performs 3 rinses with an intermediate spin (which can be reduced or excluded by using the appropriate button). It is used for rinsing any type of fabric, for example after a wash carried out by hand.

SPIN

The programme carries out a maximum spin. It is possible to delete or reduce the spin with the **SPIN SPEED** button.

DRAIN

This programme drains out the water.

RAPID (14'-30'-44')

Washing cycle suggested for low loads and slightly dirty loads. With this programme it is recommended to reduce the quantity of detergent normally used, in order to avoid unnecessary waste.

Use the RAPID button to select one of three programmes available.

DARK COLOURS

Programme designed to mix all dark garments, avoid the loss of colour and the formation of creases. We recommend the use of liquid detergent.

SHIRTS

The washing cycle is optimised to reduce the creation of creases, keeping an excellent washing performance. It is also possible to further reduce the spin speed, to ensure easier ironing.

SILK

Dedicated programme for silk fabrics that are machine washable. The rotations of the drum are delicate, the temperature does not exceed 30°C and the programme ends with a gentle spin.

WOOL

This programme performs a wash cycle dedicated to the wool fabrics that can be washed in a washing machine.

HANDWASH

A gentle programme for hand wash only fabrics with a slow spin.

TABLE OF PROGRAMMES

PROGRAMME	KG MAX	ADJUST THE DURATION AND INTENSITY OF WASH	TEMP MAX	DETERGENT DRAWER		
				2		1
WHITES	9	•	90°C	•	•	•
ECO 40-60	9		60°C	•	•	
JEANS	3		40°C	•	•	
20°C	9	•	20°C	•	•	
SYNTHETICS	4.5	•	60°C	•	•	•
DELICATES	2.5		40°C	•	•	
RINSE	-	-	-		•	
SPIN	-	-	-			
DRAIN	-	-	-			
RAPID 14'	1.5		40°C	•	•	
RAPID 30'	2.5		40°C	•	•	
RAPID 44'	3.5		40°C	•	•	
DARK COLOURS	4.5	•	40°C	•	•	•
SHIRTS	4.5	•	30°C	•	•	•
SILK	2		30°C	•	•	
WOOL	2		30°C	•	•	
HANDWASH	2		30°C	•	•	

PLEASE NOTE:

When a programme is selected, the display shows the recommended wash temperature that can be reduced (where allowed) by the relevant button.

For the programmes shown you can adjust the duration and intensity of the wash using the STAIN LEVEL button.

Selecting the RAPID programme on the knob, it will be possible to select with the RAPID button, one of the three rapid programmes available among 14', 30' and 44'.

STANDARD PROGRAMME ACCORDING TO (EU) NO 2019/2023**ECO 40-60 PROGRAMME**

CLEANING AND MAINTENANCE

NOTE:

Disconnect the machine from the power supply before cleaning and maintenance.

To clean the washing machine exterior, use a damp cloth, avoiding abrasives, alcohol and/or solvents. To maintain a good wash performance we recommend that the soap drawer and pump filters are regularly cleaned. A monthly service wash, using a proprietary cleaner is also recommended.

MAINTENANCE WASH

Run the machine with an empty drum using the Cotton Programme at 90°C with your usual detergent.

NOTE:

Do not use more than a tablespoon of detergent. This is to prevent over-foaming inside the drum. Alternatively use a suitable washing machine cleaning detergent, making sure to follow the directions on the packaging.

DRAWER CLEANING

We recommend you clean the drawer to avoid accumulating detergent and additive residue.

To do this, extract the drawer using slight force, clean it with running water and reinsert it in its housing.

Ensure the siphon cap is correctly refitted.

FILTER CLEANING

The washing machine comes with a special filter able to trap large residue, such as buttons or coins, which could clog the drain.

Ensure all the water has been emptied from the drum.

Before unscrewing the filter, we recommend you place an absorbent cloth under it to keep the floor dry. A small amount of water will come out of the filter as you remove it - this is normal.

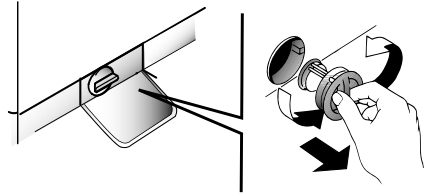

Turn the filter counter-clockwise to the stop limit.

Remove and clean the filter; when finished, replace it turning it clockwise. The filter handle will be locked when it is not possible to turn any further and the handle is horizontal. Applying a small amount of liquid soap on the filter seal will help refitting.

Repeat the previous steps in reverse order to reassemble all parts.

SUGGESTIONS FOR MOVING OR PROLONGED DISUSE

Should the washing machine be stored in an unheated room for a long period of time, drain all water from tubes.

Unplug the washing machine.

Detach the tube from the drainage system and clip on the rear of the machine and lower it, fully draining water into a bowl.

Secure the drain tube with the drainage system and clip on the rear of the machine when finished.

Keep the door glass and gasket clean.

The manufacturers warranty only covers faults within the product of a mechanical or electrical nature. Faults caused by handling, installation or misuse are not covered and may incur a charge for any repair visit to resolve.

TROUBLESHOOTING

BEFORE CALLING FOR SERVICE

Reviewing the charts on the following pages may save you from calling for service.

ERROR CODE FORMAT

MODELS WITH A DISPLAY: The error is shown by a number preceded by the letter "E" (example: E2 = Error 2).

ERROR SHOWN	POSSIBLE CAUSES AND PRACTICAL SOLUTIONS
E2 (with display)	The machine cannot load water.
	Make sure the water supply tap is open.
	Make sure the water supply hose isn't bent, kinked or trapped.
	Make sure the drain pipe is at the proper height (see installation section).
	Close the water supply tap, unscrew the filler hose from the back of the washing machine and make sure the "anti-sand" filter is clean and not blocked.
E3 (with display)	The washing machine does not drain water.
	Make sure the filter is not clogged
	Make sure the drain hose isn't bent, kinked or trapped.
	Make sure the home drainage system is not blocked and is allowing water to flow through without obstruction. Try to drain the water in the sink.
E4 (with display)	There is too much foam and/or water.
	Ensure the correct amount of detergent is being used and the detergent is designed for use in a washing machine.
E7 (with display)	Door problem.
	Make sure the door is correctly closed. Make sure the clothes inside the drum are not preventing the door from closing fully.
	If the door is locked, turn off and unplug the washing machine from the electrical supply socket, wait 2-3 minutes and reopen the door.
Any other code	Turn off and unplug the washing machine, wait a minute. Turn on the machine and restart a programme. If the error occurs again contact an Authorised Customer Service Centre directly.

PROBLEM	POSSIBLE CAUSES AND PRACTICAL SOLUTIONS
The washing machine does not work / start	Make sure the product is plugged into a working supply socket.
	Make sure power is on.
	Make sure the wall socket is working, testing it with another appliance such as a lamp.
	The door may not be correctly closed: open and close it again.
	Check whether the required programme was correctly selected and the start button pressed.
	Make sure the washing machine is not in pause or time delay mode.
Water leaked on the floor near the washing machine	This may be due to a leak from the seal between the tap, supply hose and fill valve; in this case, replace it and tighten the hose connections correctly.
	Make sure the front filter is correctly closed.
The washing machine does not spin	<p>The machine is fitted with a detection system that protects the load and product from damage if the load is not balanced before spinning. This may result in:-</p> <ul style="list-style-type: none"> - The machine attempts to balance the load, increasing the time of spin. - Reduction of the speed of spin to decrease vibrations and noise. - The spin cycle aborting to protect the machine and load. <p>If this is experienced remove the load de-tangle it, reload it and restart the spin programme.</p>
	This could be due to the fact that water has not been completely drained: wait a few minutes. If the problem persists, see Error 3 section.
	Some models include a "no spin" function: make sure it is not selected.
	Check which options are selected and their effect on the spin cycle.
	Excessive detergent can impede the spin cycle, ensure the correct amount of detergent is being used.
Strong vibrations / noises are heard during the spin cycle	The washing machine may not be fully levelled: if necessary, adjust the feet as indicated in the specific section.
	Make sure transport screws, rubber bungs and spacer tubes were removed.
	Make sure there are no foreign objects inside the drum (coins, hinges, buttons, etc).
Drum not spinning correctly	There could be an unbalanced load.
	Make sure the correct amount of clothing has been put in the drum. Remove excess clothing or add more clothing to balance the load.

The use of ecological detergents without phosphates may cause the following effects:

Cloudier rinse drain water: This effect is tied to the suspended zeolites which do not have negative effects on rinse efficiency.

White powder (zeolites) on laundry at the end of the wash: this is normal, the powder is not absorbed by fabric and does not change its colour. To remove the zeolites, select a rinse programme. In the future consider using slightly less detergent.

Foam in the water at last rinse: this does not necessary indicate poor rinsing. Consider using less detergent in future washes.

Abundant foam: This is often due to the anionic surfactants found in the detergents which are hard to eliminate from laundry. In this case, do not re-rinse to eliminate these effects: it will not help at all. We suggest conducting a maintenance wash using a proprietary cleaner.

If the problem persists or more help is required, please contact our Caple service team on **0117 938 7420** or via email **SERVICE@CAPLE.CO.UK**.





SPARE PARTS AVAILABILITY





The original spare parts for some specific components are available for a minimum of 7 or 10 years, based on the type of component, from the placing on the market of the last unit of the model.



For more info and to order spares, please contact Caple service or visit our website www.caple.co.uk



CARE SYMBOLS





The label and sign on the fabric can help you to choose the best way to launder your clothes.

Washing	
The figure quoted in the bucket is the maximum temperature the garment can be washed at. The number of bars under the symbol indicates the level of agitation permitted.	
	No bar under the symbol: = normal agitation
	One bar under the symbol: = reduced agitation
	Two bars under the symbol: = much reduced agitation
	Hand wash (if no temperature is specified, use the lowest temperature or cold)
	Do not wash

Professional cleaning	
	Dry clean only. The letters indicate the type of cleaning agent required.
	
	Professional Wet Clean only
	Do not dry clean

Bleaching	
	Any oxidising bleaching agent can be used
	Only use an oxygen based bleach or a non-chlorine bleach
	Do not bleach

Drying	
The number of dots indicates the drying temperature	
	Normal temperature
	Low temperature
	Do not tumble dry

Ironing	
The number of dots indicates the ironing temperature	
	Hot iron (max. sole plate temp. approx. 200 °C)
	Medium hot iron (max. sole plate temp. approx. 150 °C)
	Cool iron (max. sole plate temp. approx. 110 °C). Do not steam iron garments carrying this symbol as this could cause irreversible damage.
	Do not iron



Caple Service
Fourth Way
Avonmouth
Bristol
BS11 8DW

T: 0117 938 1900
E: service@caple.co.uk
www.caple.co.uk