



Integrated Tumble Dryer Instruction Manual

TDI4001



Contact Caple on 0117 938 7420 for spare parts or www.caple.co.uk

CONTENTS

Warnings	3
Environmental Protection	13
Warranty	13
Installation	14
Operation	19
Quick User Guide	21
Control Panel	22
Drying Programmes	27
Cleaning and Maintenance	29
Troubleshooting	33
Caple Contact Details	36

Keep these instructions for use with the appliance. If the appliance should be sold or passed on to others, make sure that the instructions are passed on with it. We thank you for taking note of these suggestions before installing and using the appliance. They have been written for your personal safety and the safety of others.

WARNINGS:

- Your machine is designed for use in a domestic environment. The warranty will be invalid if you use it for commercial purposes.
- This appliance is not intended for use by persons (including children) with reduced physical, sensory or mental capabilities, or lack of experience and knowledge, unless they have been given supervision or instruction concerning use of the appliance by a person responsible for their safety.
- This appliance can be used by children aged from 8 years and above and persons with reduced physical, sensory or mental capabilities or lack of experience and knowledge if they have been given supervision or instruction concerning use of the appliance in a safe way and understand the hazards involved.
- Children shall not play with the appliance.
- Cleaning and user maintenance shall not be made by children without supervision. Children of less than 3 years should be kept away unless continuously supervised.

- Keep the packing materials from your machine away from children to avoid hazards.
- Keep pets away from your machine.
- It could be possible for a child or pet to gain access to the tumble dryer through the porthole door. Therefore, please check the drum before using the appliance.
- **DO NOT** use the tumble dryer if you suspect that it is damaged in any way. Under no circumstances should you attempt to repair the appliance yourself. Repairs carried out by inexperienced persons may cause serious injury. Consult your local appointed service engineer and insist on genuine spare parts.
- The tumble dryer should be serviced by an appointed service organisation and only genuine parts used.
- It is recommended that the dryer be serviced annually by a person competent to service tumble dryers.
- It is dangerous to alter or modify the product in any way other than fitting authorised accessories.
- Do not allow fluff to accumulate around the tumble dryer. Risk of fire.
-  **WARNING: DO NOT** use the product if the fluff filter is not in position or is damaged; fluff could be ignited.
- Lint and fluff must not be allowed to collect on the floor around the outside of the machine.
- It is important to clean the lint filter after each drying cycle or the restrictions to airflow will extend drying times and could cause the safety cut-out to trip.

- It is important to clean fluff from the window of the dryer and around the door seal after each drying cycle. Failure to do so could result in water leaking.
-  Misuse of a tumble dryer may create a fire hazard.

INSTALLATION WARNINGS:

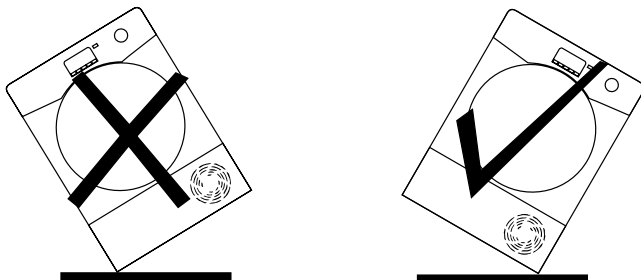

- During transport ensure that the dryer is in an upright position, if it's necessary you can flip on the side shown.
- If the product is on a different side, wait at least 4 hours so that the oil can flow back into the compressor. Failure to do this could result in damage to the compressor.
- The dryer must be installed by a Registered Installer.
- Do not install the product in a low temperature room or in a room where there is a risk of frost occurring. At temperatures around freezing point the product may not be able to operate properly: there is a risk of damage if the water is allowed to freeze in the hydraulic circuit (valves, hoses, pumps). For a better product performance, the ambient room temperature must be between 5-35°C. Please note that operating in cold conditions (between +2 and +5°C) might cause some water condensation and water drops on floor.
- Never install the dryer near curtains.

- The appliance must not be installed behind a lockable door, a sliding door or a door with a hinge on the opposite side to that of the tumble dryer, in such way that a full opening of the tumble dryer door is restricted.
- Please note it is not recommended that the dryer is placed directly next to ovens or cookers as the performance of the dryer may be affected.
- Do not stack the tumble dryer on top of other appliances.





VENTILATION WARNINGS:

- Install the rear of the appliance close to a wall or vertical surface.
- There should be a gap of at least 12mm between the machine and any obstructions. The inlet and outlet air should be kept clear of obstruction.
- **DO NOT** block the air inlets at the front and back of your dryer.
- **DO NOT** block the air inlets at the base and side of your dryer.
- Make sure carpets or rugs do not obstruct the base or any ventilation openings.
- Prevent items from falling or collecting behind the dryer as they may obstruct the air inlet and outlet.
- Adequate ventilation must be provided to avoid back flow of gases into the room from appliances burning other fuels, including open fires.

- Exhaust air must not be discharged into a flue which is used for exhausting fumes from appliances burning gas or other fuel.
- The rear of the dryer gets quite hot during use. Position the dryer so that the back is not accessible while in operation, but ensure that the sides have a space available to allow airflow.

LAUNDRY WARNINGS:

- Always refer to the laundry care labels for directions on suitability for drying.
- Fabric softeners, or similar products should be used as specified by the fabric softener instructions.
- Remove all objects from pockets such as lighters and matches.
- **DO NOT** exceed the recommended maximum load.
- **DO NOT** place articles in the dryer if anything other than a water solution has been used in the cleaning process.
- **DO NOT** dry unwashed items in the tumble dryer.
- **DO NOT** attempt to dry dripping wet articles.
- Clothes should be spin dried or thoroughly wrung before they are put into the tumble dryer.
- Under no circumstances should anything other than the recommended articles be placed in the tumble dryer.
- Glass fibre curtains should NEVER be put in this machine. Skin irritation may occur if other garments are contaminated with glass fibres.

-  **WARNING:** Foam rubber materials can, under certain circumstances, when heated become ignited by spontaneous combustion. Items such as foam rubber (latex foam), shower caps, waterproof textiles, rubber backed articles and clothes or pillows fitted with foam rubber pads **MUST NOT** be dried in the tumble dryer.
-  Do not tumble dry fabrics treated with dry cleaning fluids.
- Items that have been soiled with substances such as cooking oil, acetone, alcohol, petrol, kerosene, spot removers, turpentine, waxes and wax removers should be washed in hot water with an extra amount of detergent before being dried in the tumble dryer.
-  **WARNING:** When the hot surface symbol  is shown, the temperature rise during operation of the tumble dryer may be in excess of 60°C.
- The drum inside may be very hot. Always allow the dryer to complete the cool down period before removing the laundry.
- The final part of the tumble dryer cycle occurs without heat (cool down cycle) to ensure that the items are left at a temperature that ensures that the items will not be damaged.
-  **WARNING:** Never stop a tumble dryer before the end of the drying cycle unless all items are quickly removed and spread out so that the heat is dissipated.

- Do not lean on the door when loading the machine or use the door to lift or move the machine.
- Do not drink or reuse condensation water collected in the door container. Condensation water might be contaminated with lint; this may be hazardous to health and may cause material damage.

ELECTRICAL WARNINGS:

- Do not plug the machine in and switch it on at the mains until the installation is completed.
- The technical details (supply voltage and power input) are indicated on the product rating plate.
- Any electrical work required to install the appliance should be carried out by a qualified person.
-  **WARNING:** The appliance must not be supplied through an external switching device, such as a timer, or connected to a circuit that is regularly switched on and off by a utility. **NOT SUITABLE FOR USE WITH CONDENSING BOXES.**
- **DO NOT** use a two-way adaptor, or extension lead. The dryer must be connected to its own socket.
- This appliance must be Earthed.
- The socket outlet and the plug on the appliance must be of the same type.
- Do not touch the appliance when hands or feet are damp or wet.

- We recommend that the appliance is unplugged each time after use. It should always be disconnected from the electricity supply for long periods (i.e. weekends, if it is to be left unattended for holidays etc.).
- The special mains cable and plug assembly must only be replaced with a genuine part available from the manufacturer or service agent in order to avoid a hazard.
- Make sure that the electrical system is earthed, complies with all applicable law and that the (electricity) socket is compatible with the plug of the appliance. Otherwise, seek qualified professional assistance.
- The plug should be accessible for disconnection after the appliance has been installed.
- Always remove the plug before cleaning the appliance.



WARNING :

Fire Hazard / Flammable Materials.

- The appliance contains **R290**, an eco-sustainable refrigerating gas that is flammable. Keep open flames and sources of ignition away from the appliance.
- **DO NOT** damage the refrigerating circuit.
- Check there is no visible damage on the appliance. Do not use the appliance if it is damaged.
- Should there be any kind of problem, contact Caple Service.

WARNING:

- Ensure that the openings on the appliance and the openings of the compartment the appliance is fitted in are clear of obstructions.

WARNING:

- Do not damage the refrigerating circuit.
- Any repairs or interventions on the appliance must be carried out only by an authorised assistance service.
- Disposing of the device incorrectly could cause fires or poisoning.
- Dispose of the device correctly and do not damage the pipes used for the circulation of the refrigerating fluid.

APPROPRIATE USE:

- This appliance is intended to be used in household and similar applications such as:
 - › Staff kitchen areas in shops, offices and other working environments.
 - › Farm Houses.
 - › By clients in hotels, motels and other residential type environments.
 - › Bed and breakfast type environments.



ENVIRONMENTAL PROTECTION

Waste electrical products should not be disposed of with household waste. Please recycle where facilities exist. Check with your Local Authority or retailer for recycling advice. This appliance is marked according to the European directive on Waste Electrical and Electronic Equipment (WEEE).

By ensuring this product is disposed of correctly, you will help prevent potential negative consequences for the environment and human health, which could otherwise be caused by inappropriate waste handling of this product. The symbol on the product indicates that this product may not be treated as household waste. Instead it shall be handed over to the applicable collection point for the recycling of electrical and electronic equipment. Disposal must be carried out in accordance with local environmental regulations for waste disposal.

For more detailed information about treatment, recovery and recycling of this product, please contact your local council, your household waste disposal service or the retailer where you purchased the product.

CE DECLARATIONS OF CONFORMITY

This appliance has been manufactured to the strictest standards and complies with all applicable legislation, Low Voltage Directive (LVD) and Electromagnetic Compatibility (EMC).

UKCA DECLARATIONS OF CONFORMITY

This appliance has been manufactured to the strictest standards and complies with all applicable legislation.

TECHNICAL FICHE

This appliance conforms to all current and applicable energy regulations. To view the Technical Fiche that supports the energy labelling data, please visit the product page on our website www.caple.co.uk

WARRANTY:

Your new appliance is covered by warranty. The warranty card is enclosed - if it is missing, you must provide the following information to your retailer in order to receive a replacement: date of purchase, model and serial number. Registration can also be completed online by visiting www.caple.co.uk.

Ensure you keep your warranty card safe, you may need to show it to Caple Service together with proof of purchase.

If you fail to show your warranty card you will incur all repair charges.

Spare parts are only available from Caple Service and spare parts authorised centres.

INSTALLATION

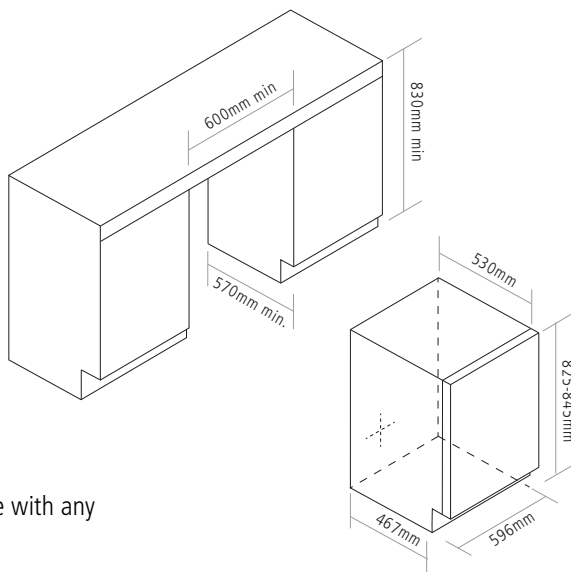

The tumble dryer is fully compatible with any 600mm deep kitchen units.

ADJUST THE HEIGHT OF THE DRYER

The 4 adjustable feet allow the height of the dryer to be adjusted from 825mm to a maximum of 845mm. Once the tumble dryer is in place, you can adjust the height by rotating the adjustable feet, to ensure the machine is level.

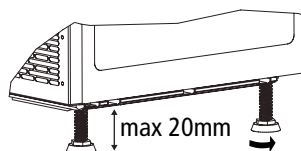

NOTE:

We suggest to put the dryer at the maximum height possible in order to avoid tilting, leaving at least 5mm from the top of the furniture.

Before fixing the hinges it's necessary to determine the depth of the dryer from the front part of the kitchen according to the depth of the kick plate (see diagram) and choose the right installation option.

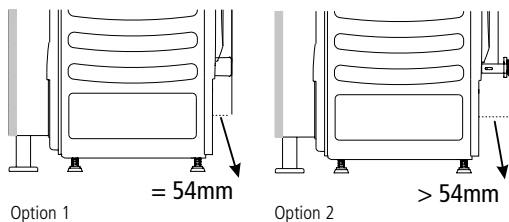

NOTE:

The distance does not consider the thickness of the kick plate of the kitchen.

MOUNTING THE FURNITURE DOOR TO THE APPLIANCE

When the position of the plinth is set back less than 54mm from the front of the furniture, install according to the following:

- › Position the template onto the reverse of the furniture door. It is possible to mount the hinges and closure magnet on the right or left-hand side depending on your requirements. Mark the screw hole positions then drill them out.

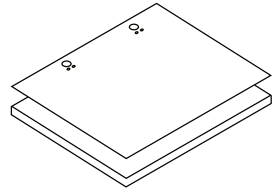

NOTE:

We suggest mounting the furniture door so that it opens towards the left, same direction as the porthole door.

- › Fix the hinges in place (on the door) with the 4 screws provided (1).
- › Fix the magnet (2) in place using screw (3).
- › If necessary, use the gasket (4) to adjust and achieve the appropriate assembly (down side).

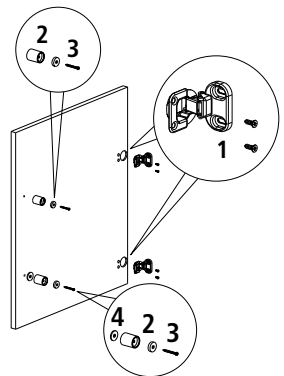

- › Mount the plate (5) on the right or left-hand side, depending on your installation requirements.
- › Place the plastic support (6) under the plate and fix it in position with screw (7).

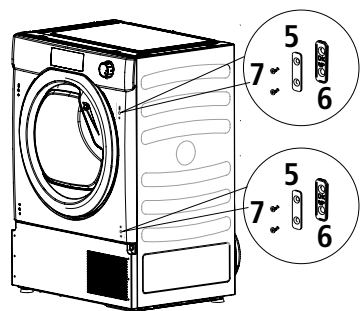

- › Mount the furniture door to the front of the dryer using the hinges.
- › Fix the spacers (1) in place with the 2 screws (2) and then fix the hinges with 2 screws (3).

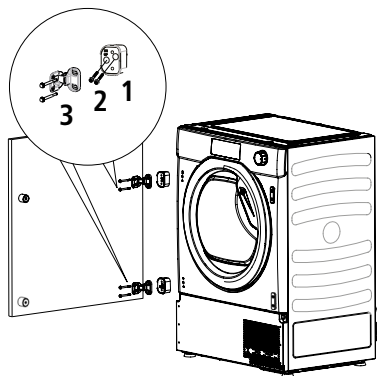

PLINTH VENTILATION

The plinth must have ventilation slots (min side/diameter 127mm hole) according to the dimensions on the fixing template. If the plinth is not high enough to accommodate the entire hole, cut only part of it.

- › Place the template onto the reverse of the plinth. Mark the screw hole positions, then drill them out.
- › Fix the plinth to the kick plate using 6 screws provided. (J)

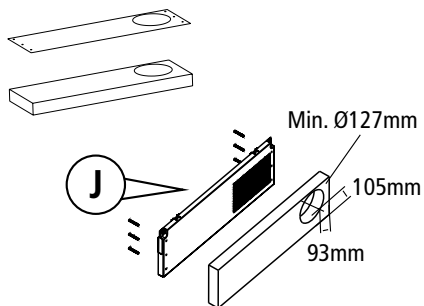

NOTE:

This is only possible with some types of kick plate (e.g. wood or plastic). We suggest to check with the kitchen suppliers.

- › Fix the kick plate to the dryer.
- › When using the full door, the door must have min $\text{Ø}127\text{mm}$ hole across the slots of the kick plate.

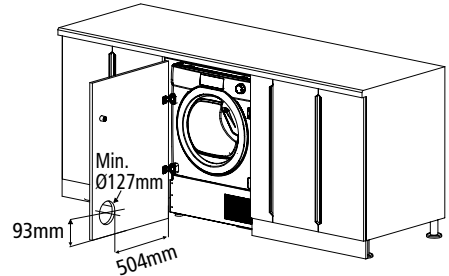
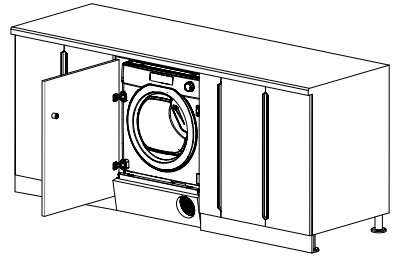

WARNING:

Without the airflow ventilation hole in the furniture door/plinth we can not guarantee the correct functionality of the appliance.

PLINTH GRILLE

When installing the appliance with a 150mm high (or less) plinth, it is possible to purchase a stainless-steel grille (GRILL/SENSE300) for the plinth cut out. To purchase, visit www.caple.co.uk.



ALTERNATIVE INSTALLATION - MOUNTING THE FURNITURE DOOR TO THE CARCASS

When the position of the plinth is set back more than 55 mm from the front of the furniture, install according to the following:

NOTE:

Components not supplied:

- › Hinges
- › Supports
- › Door stop

Firstly, slide the dryer into an opening of the size indicated on page 14.

NOTE:

As soon as the hinges are fixed on the furniture is not possible to slide the dryer in and out.

- › Fix the to the door of the furniture with standard hinges and supports (not supplied) and stop the door with a std hook (not supplied).

 Pay attention to position the bottom hinge is 40mm above the kick plate in order to facilitate it's removal.

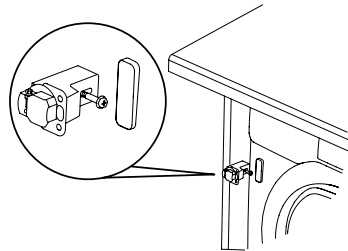

- › Fix the hinges to the door furniture.
- › Use the N°4 mount caps (7) to cover all the holes on the front of the dryer.

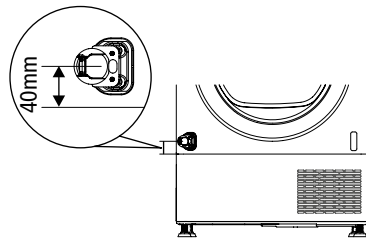

If the distance between the top of the dryer and the top of the furniture is more than 10mm, fix the N°2 L metal brackets (K) to the furniture sides, to avoid possible tilting.

A furniture plinth may now be run across the front of the dryer, but it's height will be dictated by the front kick plate.

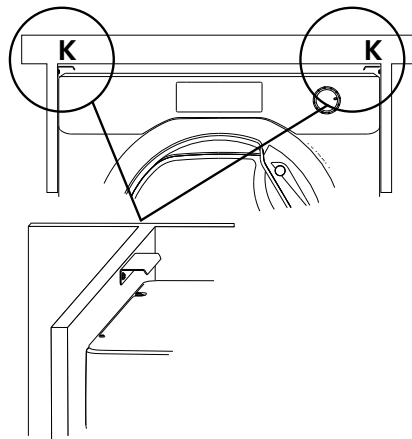

OPERATION

Before using the tumble dryer for the first time:

- › Please read this instruction booklet thoroughly.
- › Remove all items packed inside the drum.
- › Wipe the inside of the drum and door with a damp cloth to remove any dust which may have settled in transit.

CLOTHES PREPARATION

Make sure that the laundry you are going to dry is suitable for drying in a tumble dryer, as shown by the care symbols on each item.

Check that all fastenings are closed and that pockets are empty. Turn the articles inside out. Place cloths loosely in the drum to make sure that they don't get tangled.

DO NOT TUMBLE DRY

Silk, Nylon stockings, delicate embroidery, fabrics with metallic decorations, garments with PVC or leather trimmings.



IMPORTANT:

Do not dry articles which have been treated with a dry cleaning fluid or rubber cloths (danger of fire or explosion).

During the last 15 minutes, the load is always tumbled in cool air.

ENERGY SAVING





Only put into the tumble dryer laundry which has been thoroughly wrung or spin-dried. The drier the laundry the shorter the drying time thus saving electricity.

Always: Check that the filter is clean before every drying cycle.

Never: Put dripping wet items into the tumble dryer, this may damage the appliance.

DRYING GUIDE

The standard cycle COTTON DRY () is the most energy efficient and best suited for drying normal wet cotton laundry. The table below shows the approximate time and energy consumption of the main drying programmes.

	CAPACITY (KG)	7
	CLASS	A+
 Whites	Energy kWh	2,83
	Time Min.	302
 Whites	Energy kWh	2,62
	Time Min.	278
 Cotton	Energy kWh	2,25
	Time Min.	244
 Cotton ½	Energy kWh	1,20
	Time Min.	140
 Whites	Energy kWh	1,76
	Time Min.	194

INFORMATION FOR TEST LABORATORY

EN 61121 Programme To Use

Standard dry cotton → 

Iron Dry cotton → **Whites**

Easy-Care Textile → **Synthetics**

SORTING THE LOAD

Sort the load by cares symbols. These can be found on the collar or inside the seam:

 Suitable for tumble drying

 Tumble drying at low temperature only

 Tumble drying at high temperature



 Do not tumble dry

If the item does not have a care label, it must be assumed that it is not suitable for tumble drying.

- › **By amount and thickness:** Whenever the load is bigger than the dryer capacity, separate clothes according to thickness (e.g. towels from sheets).
- › **By type of fabric cottons / linen:** Towels, cotton jersey, bed and table linen.
- › **Synthetics:** Blouses, shirts, overalls etc. made of polyester or polyamid, as well as cotton/synthetic mixes.

Do not overload the drum. Large items when wet, exceed the maximum admissible clothes load (for example: sleeping bags, duvets).

QUICK USER GUIDE

1. Open the door and load the drum with laundry. Ensure that garments do not hinder closure of the door.
2. Gently close the door pushing it slowly until you hear the door “click” shut.
3. Turn the programme selector dial to select the required drying programme (see programme guide).
4. Press the  button . The dryer will start automatically and the indicator above the button will be continuously lit.
5. If the door is opened during the programme to check the laundry, it is necessary to press  to recommence drying after the door has been closed.
6. When the cycle is nearing completion the machine will enter the cool down phase, the clothes will be tumbled in cool air allowing the load to cool down.
7. Following the completion of the cycle the drum will rotate intermittently to minimise creasing. This will continue until the machine is switched OFF or the door is opened.
8. When the programme is complete the LED indicator will light.



Do not open the door during the automatic programmes in order to obtain a good drying result.

CONTROL PANEL

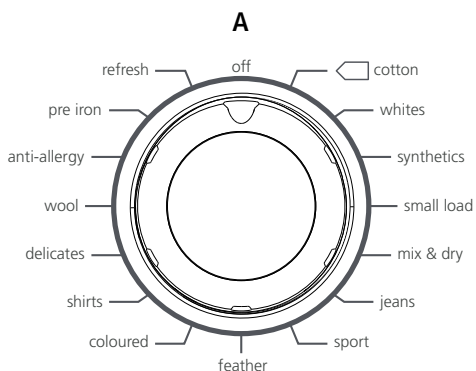
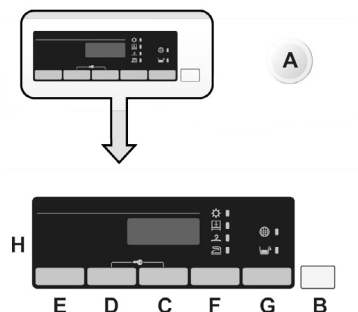

WARNING:

Do not touch the buttons while inserting the plug because the machine calibrates the systems during the first seconds: touching the buttons will cause the machine to not work properly. In this case, remove the plug and repeat the operation.

LANGUAGE SETTING

After connecting the machine to electrical network and turning it on, press the 'F' or 'G' button to see the available languages on the display. English is always the first language shown. Select the desired language by pressing the 'START/PAUSE' button. Changing the language: If you want to change the language setting, simultaneously press the 'F' and 'G' buttons for 5 seconds. 'ENGLISH' will appear on the display and you will be able to select a new language.

A - PROGRAMME SELECTOR

Rotate the knob in either direction to select the desired drying programme. To cancel the selections or switch off the dryer, rotate the knob to OFF.

B - START / PAUSE BUTTON

To start the selected programme and/or suspend it.

NOTE:

- › Close the porthole before pressing the **START/PAUSE** button.
- › To start the selected cycle with the pre-set parameters, press START/PAUSE. When the programme is running, the display will show the time to elapse.
- › If you want to modify the chosen programme, press the desired options buttons, modify the default parameters and then press START/ PAUSE button to start the cycle.

NOTE :

Only the options compatible with the set programme can be selected.

PROGRAMME DURATION

- › When a programme is selected the display automatically shows the cycle duration, which can vary, depending on the options selected.
- › Once the programme has started you will be kept informed constantly of the time remaining to the end of the drying cycle.
- › The appliance calculates the time to the end of the selected programme based upon a standard loading, during the cycle, the appliance corrects the time to the humidity level of the load.

PROGRAMME END

- › “END” (“End” on some models) will appear in the display at the end of the programme, it is now possible to open the door.
- › At the end of the cycle, turn off the appliance by turning the programme selector to the off position.

NOTE:

The programme selector must always be turned to the Off position at the end of the drying cycle before a new one can be selected.

PAUSING THE MACHINE

- › Keep the START/PAUSE button pressed for about 2 seconds (the name of the programme and the residual time display will flash, showing that the machine is paused).
- › Press the START/PAUSE button again to re-start the programme from the point it had been paused at.

CANCELLING THE SET PROGRAMME

> To cancel the programme, turn the programme selector to the off position.

NOTE:

If there is a break in the power supply whilst the machine is operating, when the power is restored, by pressing the START/PAUSE button, the machine will restart from the beginning of the phase it was in when the power was lost.

C - DELAY BUTTON

It allows to delay the start of the programme from 1 to 24 hours in 1-hour intervals. The delay selected is shown on the display. After pressing the START/PAUSE button the time shown decreases hour by hour. If you open the porthole door with delayed start set, after re-closing the porthole, press Start again to resume the counting.

D - TIME SELECTION BUTTON

It's possible to transform a cycle from automatic to programmed, up to 3 minutes after the start of the cycle. The progressive pressure increases the time in 10-minute intervals. After this selection, to reset the automatic drying functioning it is necessary to switch the dryer off. In case of incompatibility, all LEDs flash quickly 3 times.

E - MEMORY BUTTON

This option allows you to store the options set on a cycle.

MEMORY: Select the programme and the desired options, then press the MEMORY button for 3 seconds (before starting the cycle). The control light "memory" will blink for 2 seconds and the options connected to the cycle selected will be set.

RECALL: After the selection of the cycle, push the MEMORY button for recall of the stored options (not the cycle).

NOTE:

The delay start function cannot be memorised.

F - DRYING SELECTION BUTTON

This allows you to select the required dryness level, it is possible to choose for up to five minutes after the start of a drying cycle:

 **Ready to Iron:** Leaves the garments slightly wet to facilitate ironing.

 **Hanger Dry:** To make a garment ready to be hung on a coat hanger.

 **Wardrobe Dry:** For laundry that can be directly stored.

 **Extra Dry:** To get completely dry garments; ideal for full load.

This appliance is equipped with a Drying Manager Function. On automatic cycles, each level of intermediate drying, prior to reaching the one selected is indicated by a flashing neon light that indicates the degree of dryness that the garments have reached. In case of incompatibility, all LEDs flash quickly 3 times.

G - ANTI CREASE BUTTON

During the cycle the option sets alternate movements of the drum to reduce the folds and automatically sets the drying level to "Ready to Iron". This option activates an anti-crease movement of the drum pre-cycle in case of activation of the delay and at the end of drying cycle. It is activated every 10 minutes, up to 6 hours after the end of the drying cycle. To stop the movements, set the programme selector to OFF. This is useful when it's not possible to immediately remove the laundry.

H - DISPLAY

The display shows the remaining time for drying, the time until a drying cycle will start (if delayed start has been activated) and other notifications setting.

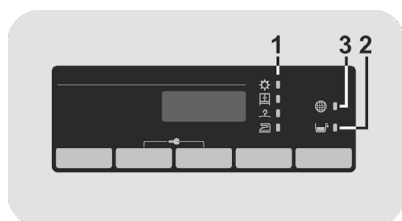

1. **Drying Selection Indicator Lights:**

These lights display the degrees of dryness that can be selected by the relevant button.

2.  **Water Tank:** Lights up when it is necessary to empty the water tank.

3.  **Filter Cleaning:** Lights when the cleaning of the filters is necessary (the door and the lower filter).

C + D - CHILDLCK BUTTON

This function allows you to prevent unwanted changes during the drying phase. Activation/ Inactivation: Push buttons 'C' and 'D' simultaneously for two seconds. In case of opening the 'porthole' with activated child lock, the cycle stops but the lock is kept. To restart the cycle, you must remove the lock and press START/PAUSE again.

When the dryer is off, the option is automatically inactivated. Child lock can be modified at any time of the cycle.

DRYING PROGRAMMES

PROGRAMME	PROGRAMME DESCRIPTION	CAPACITY (KG)	DRYING TIME (MIN)
COTTON	The cotton programme (hang dry) is the most efficient programme for energy consumption. Suitable for cottons and linens.	Full	*
WHITES	To dry cottons, sponges and towels.	Full	*
SYNTHETICS	To dry synthetic fabrics that need an accurate and specific treatment.	3	*
SMALL LOAD	Dedicated to get an even drying for extremely small loads without the risk of overdrying.	2	*
MIX & DRY	To dry different kind of fabrics as mix, synthetics together.	3	*
JEANS	Dedicated to fabrics like jeans or denim. It's recommended to turn the garments inside out before drying.	3	*
SPORT	For technical garments for sport and fitness, drying gently with special care to avoid shrinking and deterioration of elastic fibers.	3	*
FEATHER	Perfect cycle to dry duvets and quilts, revitalising the smoothness of the feathers.	3	*
COLOURED	A delicate and specific cycle to dry dark or colour cotton or synthetics garments.	3	*
SHIRTS	This specific cycle has been conceived to dry shirts minimizing tangles and folds thanks specific movements of the drum. It's recommended to take out the linens immediately after drying cycle.	2	*
DELICATES	To dry delicate fabrics that need an accurate and specific treatment.	3	*
WOOL	Woolen clothes: the programme can be used to dry up to 1kg of laundry (around 3 jumpers). It is recommended to reverse all clothes before drying. Timing can change due to dimensions and thickness of load and to spinning chosen during washing. At the end of the cycle, clothes are ready to be worn, but if they are heavier, edges can be a bit wet: it is suggested to dry them naturally. It is recommended to unload clothes at the very end of the cycle. Attention: felting process of wool is irreversible; please dry exclusively clothes with symbol (symbol "ok tumble"); this programme is not meant for acrylic clothes.	1	70'
ANTI-ALLERGY	One specific cycle that dry and in the same time helps to reduce the main allergens as dustmites, pet hair, pollens and residual of powder detergents.	3	Max 220'
PRE-IRON	This is a warm cycle that in only 12 minutes helps to relax folds and creases.	2	12'
REFRESH	The perfect cycle to remove the smells from the linens smoothing creases.	2	20'

*  **WARNING:**

The real duration of drying cycle depends by the starting humidity level of the laundry due to spin speed, type and amount of load, cleanliness of filters and ambient temperature.

Please pay attention that overloading or bulky loads can lead to the door opening. In this case, please reduce the load capacity to continue the drying cycle.

PROGRAMMES AND OPTIONS COMPATIBILITY

PROGRAMMES	SELECTABLE OPTIONS				
	DELAY	DRYING SELECTION	TIME SELECTION	ANTI CREASE	MEMORY
COTTON	•				•
WHITES	•	•	•	•	•
SYNTHETICS	•	•	•	•	•
SMALL LOAD	•				•
MIX & DRY	•	•	•	•	•
JEANS	•				•
SPORT	•	•			•
FEATHER	•				•
COLOURED	•	•		•	•
SHIRTS	•	•		•	•
DELICATES	•	•	•	•	•
WOOL	•				•
ANTI-ALLERGY	•		•		•
PRE IRON	•				•
REFRESH	•				•

CLEANING AND MAINTENANCE

CLEANING THE DRYER

- › Clean the filter and empty the water container after every drying cycle.
- › Regularly clean the bottom filter.
- › After each period of use, wipe the inside of the drum and leave the door open for a while to allow circulation of air to dry it.
- › Wipe the outside of the machine and the door with a soft cloth.
- › **DO NOT** use abrasive pads or cleaning agents.
- › To prevent the door sticking or the build up of fluff, clean the inner door and gasket with a damp cloth after every drying cycle.
- › Frequently check the fluff filter after use and clean if necessary.
*Air outlet (depending on model).

WARNING:

The drum, door and load may be very hot.

IMPORTANT:

Always switch off and remove the plug from the electricity supply before cleaning this appliance. For electrical data refer to the rating label on the front of the dryer cabinet (with the door open).

WARNING:

If you open the door mid cycle, before the cool down cycle has completed, the handle may be hot. Please use extreme caution when attempting to empty the water reservoir during the cycle.

Clean the filters before every cycle.

Pay attention that overloading or a bulk load can lead to the door opening. In this case, reduce the load capacity to continue the drying cycle.

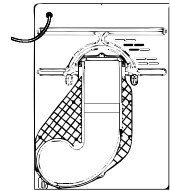
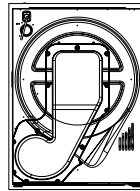

WATER CONTAINER

The water removed from the laundry during the drying cycle is collected in a container inside the door of the dryer. When the container is full the  indicator on the control panel will light, and the container **MUST** be emptied. However we recommend that the container is emptied after each drying cycle.

NOTE:

Very little water will collect during the first few cycles of a new machine as an internal reservoir is filled first.

REMOVING THE CONTAINER TANK IN THE DRAWER

- › Gently pull out the water container holding the handle. When it is full the water container will weigh about 6kg.
- › Tilt the water container to empty the water out through the spout.
- › When empty, replace the water container back as shown below. First insert the base of the container into position as shown (1) then gentle push the top into position (2).
- › Press  button to restart the cycle.

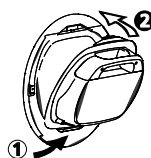
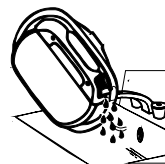
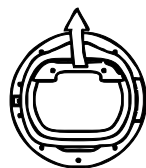

DOOR AND FILTERS

Pull on handle to open the door.

To restart the dryer, close the door and press start/pause button .

WARNING:

When the tumble dryer is in use the drum and door may be **VERY HOT**.

FILTERS

- › Pull the filter upwards.
- › Open filter as shown.
- › Gently remove lint using a soft brush or your fingertips.
- › Snap the filter together and push back into place.

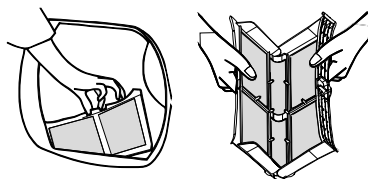

IMPORTANT:

To maintain the efficiency of the dryer, check that the fluff filter is clean before each drying cycle.

FILTER CARE INDICATOR

 Lights when the filter needs cleaning.

If the laundry is not drying check that the filter is not clogged.

Clogged filters could increase the drying time and cause damages and expensive cleaning operation. If you clean filters under water, remember to dry them.

CLEANING THE CONDENSER FILTER



Remove the kick plate.



Turn the locking levers ant-clockwise and pull out the front cover.



Gently remove the filter frame and clean any dust or fluff with a cloth from the filter. Do not use water to clean the filter.

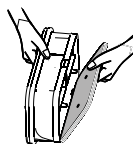

Remove the sponge gently from its place and then wash the sponge by holding it under a running tap turning it so to remove any dust or fluff.

Refit the front cover ensuring it is in the correct way (as indicated by the arrow) and pushed firmly into place.

Lock the levers by turning them clockwise.



Refit the kick plate.



WARNING:

Clean the filters before every cycle. Overloading or a bulk load can lead to door opening. In this case reduce the load capacity to continue the drying cycle.

TROUBLESHOOTING

BEFORE CALLING FOR SERVICE

Reviewing the information below may save you from calling for service.

DRYING TIME IS TOO LONG/CLOTHES ARE NOT DRY ENOUGH ON:

- › Have you selected the correct drying time/programme?
- › Were the clothes too wet? Were the clothes thoroughly wrung or spin-dried?
- › Does the filter need cleaning?
- › Is the dryer overloaded?

THE DRYER DOES NOT OPERATE:

- › Is there a working electricity supply to the dryer? Check using another appliance such as a table lamp.
- › Is the plug properly connected to the mains supply?
- › Is there a power failure?
- › Has the fuse blown?
- › Is the door fully closed?
- › Is the dryer switched on, both at the mains supply and at the machine?
- › Has the drying time or the programme been selected?
- › Has the machine been switched on again after opening the door?

THE DRYER IS NOISY ON:

- › Switch off the dryer and contact Service for advice.

THE FILTER CLEANING INDICATOR IS ON:

Does the filter need cleaning?

THE WATER TANK INDICATOR IS ON:

Does the water container need emptying?

THE HUMIDITY IN THE ROOM INCREASES

This is not a fault with the product. Humidity and condensation can form in the room when the product is in use. Ensure the room is adequately ventilated.

If the problem persists or more help is required, please contact our Caple service team on **0117 938 7420** or via email **service@caple.co.uk**.



Caple Service
Fourth Way
Avonmouth
Bristol
BS11 8DW

T: 0117 938 1900
E: service@caple.co.uk
www.caple.co.uk