



# Range cooker instruction manual

## CR9209



Contact Caple on 0117 938 7420 or for spare parts [www.caple.co.uk](http://www.caple.co.uk)





## CONTENTS

Safety instructions	3
Environmental protection	5
Warranty	6
For your safety	7
Instructions for installation	8
Electrical connection	9
Room ventilation	10
Gas installation	10
Instructions for use	15
Instructions for cooking	18
Maintenance and Cleaning	20
How to remove the oven door	21
Replacing the oven lamp	21
Caple Service contact details	24

Please keep this instruction manual for future reference





## SAFETY INSTRUCTIONS

This appliance is not intended for use by persons (including children) with reduced physical, sensory or mental capabilities, or lack of experience and knowledge, unless they have been given supervision or instruction concerning use of the appliance by a person responsible for their safety.

Children should be supervised to ensure that they do not play with the appliance.

Cleaning and user maintenance must not be made by children without supervision.

Never immerse the appliance in water.

This product is not designed for commercial use, it is a household appliance only. It is not intended to be used in:

- Staff kitchen areas in shops, offices and other working environments,
- Bed and breakfast type environments,
- By clients in hotels, motels and other residential type environments.

To avoid all risk, if the power cable is damaged, it must only be replaced by a Caple appointed engineer.

Appliances can be used by persons with reduced physical, sensory or mental capabilities or lack of experience and knowledge if they have been given supervision or instruction concerning use of the appliance in a safe way and understand the hazards involved.

Children must not play with this appliance.

When not in use and before cleaning, always isolate the appliance from the electrical supply.

## IMPORTANT

Read the instruction manual carefully before using the appliance for the first time.

This appliance must only be used for the purpose it is intended, for example domestic cooking. Other types of use are not permitted and may prove dangerous. Caple will not be held liable for any damage caused by the incorrect use of the appliance.

Do not use any accessories or attachments not recommended by Caple as this may result in fire, electric shock or injury.

To protect against fire, electrical shock and injury to persons, do not immerse cords or plugs in water or any other liquid.

Never touch the appliance with wet or damp hands.

Never pull the power cable as you could damage it.

If the appliance is faulty, do not attempt to repair it. Isolate it from the mains electric supply and contact Caple Service either by phone 0117 938 7420 or email [service@caple.co.uk](mailto:service@caple.co.uk).

Keep all packaging (including plastic bags, polystyrene foam etc) out of the reach and away from children.

Do not rest large or unstable objects on any part of the appliance.

## IMPORTANT

Caple cannot be held responsible for injuries or losses caused by incorrect use or installation of this product. Please note that Caple reserve the right to invalidate the guarantee supplied with this product following incorrect installation or misuse of the appliance. Under no circumstances should any external covers be removed for servicing or maintenance except by suitably qualified personnel.



## CE DECLARATIONS OF CONFORMITY

This appliance has been designed, constructed and marketed in compliance with safety requirements in force.

This appliance has been manufactured to the strictest standards and complies with all applicable legislation, including

- 73/23/EEC regarding "low Voltage".
- 89/336/EEC regarding " Electromagnetic Disturbances".
- 90/396/EEC regarding "Gas appliances".
- 89/109/EEC regarding "Materials in contact with food"

Moreover the above mentioned Directives comply with Directive 93/68/EEC.

- This household appliance has been designed for cooking and it must therefore be used for this purpose only



## ENVIRONMENTAL PROTECTION

Waste electrical products should not be disposed of with household waste. Please recycle where facilities exist. Check with your Local Authority or retailer for recycling advice.

This appliance is marked according to the European directive 2002/96/EC on Waste Electrical and Electronic Equipment (WEEE). By ensuring this product is disposed of correctly, you will help prevent potential negative consequences for the environment and human health, which could otherwise be caused by inappropriate waste handling of this product. The symbol on the product indicates that this product may not be treated as household waste. Instead it shall be handed over to the applicable collection point for the recycling of electrical and electronic equipment. Disposal must be carried out in accordance with local environmental regulations for waste disposal.

For more detailed information about treatment, recovery and recycling of this product, please contact your local council, your household waste disposal service or the retailer where you purchased the product.

Please keep this instruction manual for future reference

## CAUTION

Carefully read these instructions before using the appliance and keep them for future consultation.

Keep potentially hazardous packaging (plastic bags, polystyrene etc.) out of the reach of children.

## WARRANTY

Your new appliance is covered by warranty. The warranty card is enclosed - if it is missing, you must provide the following information to your retailer in order to receive a replacement: date of purchase, model and serial number (placed on the inside of the front appliance drawer).

Ensure you keep your warranty card safe, you may need to show it to Caple Technical Service together with proof of purchase.

If you fail to show your warranty card you will incur all repair charges. Spare parts are only available from Caple Technical Service and Spare Parts Authorised Centres.

## ATTENTION

- Before use, remove all plastic films protecting some parts of the appliance (fascia - panel, parts in stainless steel, etc)
- Do not use the appliance to heat the room.
- When the appliance is not in use, we recommend you turn it off, isolate from the electrical supply and ensure all gas taps are closed.

## IN THE EVENT OF A FIRE:

In the event of a fire, close the main valve of the gas pipe immediately and disconnect electrical supply. DO NOT pour water over flaming oil in any instance.

Do not store or use flammable products or aerosol containers near the burners when on or off.



## **FOR YOUR SAFETY**

Do not place children's toys above or near the appliance.

Keep children well away from the appliance: pans and parts of the appliance become very hot during use, also consider cooling down time.

To avoid accidents, pan handles should be turned to the back of the cooker, not out to the room or over adjacent burners.

When cooking, ensure you wear appropriate clothing. Avoid loose clothing (especially on the arms) and flammable materials; in the event of a fire such clothing may be a hazard resulting in serious injuries.

## **WARNING**

- Parts of the oven become hot when on, please keep children away from appliance to avoid any injuries.
- Never cook food directly onto the base of the oven
- Take care when opening and closing the oven door to avoid trapping fingers or objects in hinges
- Do not let children play with the oven door.
- Do not sit or put weight on the door while it is open

## **LOWER STORAGE DRAWER**

Do not put any flammable or plastic utensils in the storage drawer below the oven.



## INSTRUCTIONS FOR INSTALLATION

### Dimensions and installation features

#### WARNING:

- Prior to installation, ensure that the local distribution conditions (nature of the gas and gas pressure) and the adjustment of the appliance are compatible.
- The adjustment conditions for this appliance are stated on the rating plate.
- This appliance is not connected to a combustion products evacuation device.  
It should be installed and connected in accordance with current installation regulations. Particular attention should be given to the relevant requirements regarding ventilation.

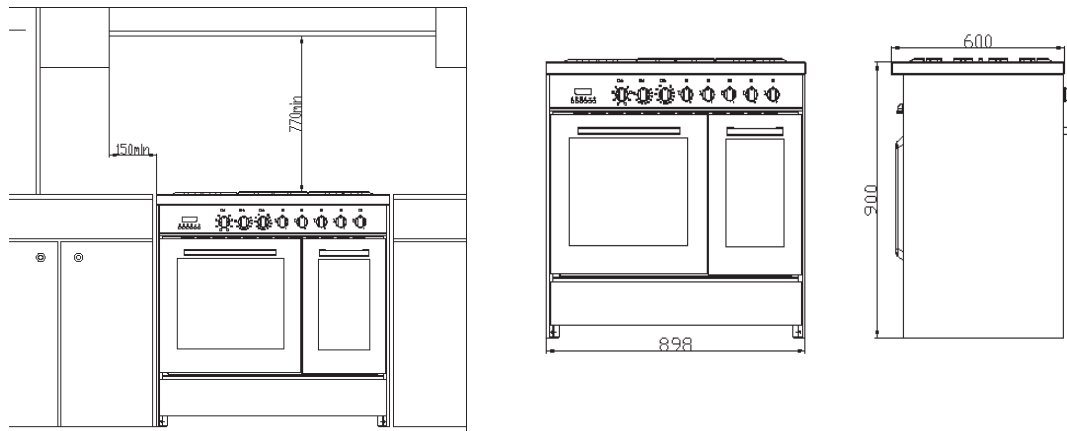

The cooker is supplied with an anti-tilting chain to prevent the appliance from tilting forward and causing accidental damage to the gas pipe. Make a hole in the wall behind, at the same height as the fixing chain. Insert the plug into the hole and then screw in the hook until it is firmly fixed to the wall. Fix the chain to the hook. You can adjust to level of the cooker by inserting the feet provided.

Equipment type: freestanding (class 1)  
Insulation class: class 1

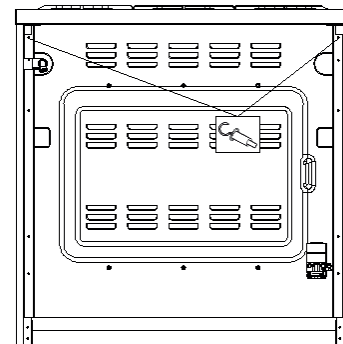



## ELECTRICAL CONNECTION

The appliance must be installed by a qualified person in accordance with the latest edition of the IEE Regulations and in compliance with the manufacturer instructions. Ensure that the voltage is the same as that stated on the rating plate. The rating plate can be found on the inside of the appliance storage drawer.

### **WARNING: THIS APPLIANCE MUST BE EARTHED**

The power supply must be fitted with a disconnect switch in which the distance between contacts permits total disconnection in accordance with overvoltage category III, as required by installation regulations.

Be sure that the earth wire (green/yellow) is not interrupted by the switch

Cable type HO5RRF3×2.5mm<sup>2</sup>

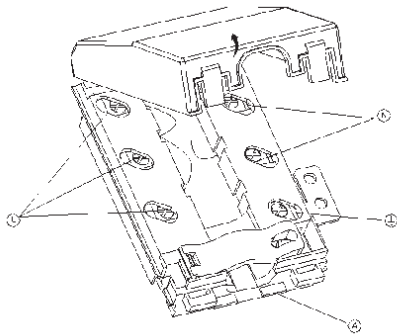

### Connection of the feeding cable to the mains

Connect the feeding cable to a plug suitable for the maximum load indicated on the rating plate of the product. If you are directly connecting the cable to the mains without a plug, it is necessary to insert a suitable omni-polar switch to the appliance, with minimum opening between contacts of 3mm (the earth wire should not be interrupted by the switch).

Before connecting to the mains, make sure that:

- The electrical counter, the safety valve, the feeding line and the socket are adequate to withstand the maximum load required (see rating plate).
- The supply system is regularly earthed according to the current regulations.
- The socket or the omni-polar switch can easily be reached after the installation of the oven.
- After carrying out the connection to the mains, check that the supplying cable does not come into contact with parts that may get hot.
- Never use reductions, shunts, adaptors which can cause overheating or burning.

The manufacturer is not liable for any direct or indirect damage caused by faulty installation or connection. It is therefore necessary that all installation and connection operations are carried out by qualified personnel complying with the local and general regulations in force.

Please keep this instruction manual for future reference

## ELECTRICAL FEATURES

Oven light	2× 25 W
Top inner heating element (NATURAL CONNECTION OVENS)	1200W
Top outer heating element (NATURAL CONNECTION OVENS)	800W
Bottom heating element (NATURAL CONNECTION OVENS)	1200W
Top inner heating element (MULTIFUNCTIONAL OVENS)	2250W
Top outer heating element (MULTIFUNCTIONAL OVENS)	1800W
Bottom heating element (MULTIFUNCTIONAL OVENS)	1250W
Rear heating element (MULTIFUNCTIONAL OVENS)	1800W
Ventilator motor	15W
Cooling fan	18W

## ROOM VENTILATION

- The appliance should be installed into a kitchen, room or space with an air supply in accordance with BS 5440-2: 2000.

### Note:

Regardless of room size, all rooms containing the appliance must have direct access to the outside air via a window that can be opened or equivalent.

- Where there are other fuel burning appliances in the same room, BS 5440-2: 2000 should be consulted to determine the correct amount of free area ventilation requirements.
- The above requirements allow also for use of a gas oven and grill but if there are other gas burning appliances in the same room, consult a qualified engineer.

## GAS INSTALLATION

### IMPORTANT

This appliance is supplied for use on NATURAL GAS or LPG (check the gas label attached on the appliance).

- Appliances supplied for use on NATURAL GAS: they are adjusted for this gas only and cannot be used on any other gas (LPG) without modification. The appliances are manufactured for conversion to LPG.

### Installation and Service Regulations (United Kingdom)

It is a legal requirement that all gas appliances are Installed and Serviced by a competent person in accordance with the current editions of the following Standards and Regulations or those regulations appropriate to the geographical region in which they are to be installed:

- Gas Safety (Installation and Use) Regulations
- Building Regulations
- British Standards
- Regulations for Electrical Installation

Installation and service of any gas product must be made by a suitably qualified and registered person competent on the type of appliance being installed or serviced and holding a valid certificate of competence for the work being carried out. Currently the proof of competence is the Accredited Certification Scheme (ACS) or S/NVQ that has been aligned to the ACS. It is also a requirement that all businesses or self employed installers are members of a class of person approved by the Health and Safety Executive. Failure to install the appliance correctly could invalidate any manufacturers warranty and lead to prosecution under the above quoted regulation.

Please keep this instruction manual for future reference



## Gas Connection

The installation of the gas appliance to Natural Gas or LP Gas must be carried out by a suitably qualified and registered installer. Installers shall take due account of the provisions of the relevant British Standards Code of Practice, the Gas Safety Regulations and the Building Standards (Scotland) (Consolidation) Regulations issued by the Scottish Development Department.

### Installation to Natural Gas

Installation to Natural Gas must conform to the Code of Practice, etc.  
The supply pressure for Natural Gas is 20 mbar.  
The installation must conform to the relevant British Standards.

### Installation to LP Gas

When operating on Butane gas a supply pressure of 28-30 mbar is required.  
When using Propane gas a supply pressure of 37 mbar is required.  
The installation must conform to the relevant British Standards.

## WARNING:

Only a suitably qualified and registered installer, also with technical knowledge of electricity should install the appliance. They should observe the Regulations and Codes of Practice governing such installation of gas appliances.

## Note:

It is recommended that the gas connection to the appliance is installed with a flexible connecting tube made to BS5386, conforming to all required British Standards

- Flexible hoses can be used where the sited ambient temperature of the hose does not exceed 70°C. These hoses must be manufactured in accordance with BS669 part 1 and be of the correct construction for the type of gas being used.
- Gas hoses designed for natural gas **MUST NOT** be used for supplying LPG gas (LPG gas hoses can be identified by a either a red band or stripe on the rubber outer coating of the hose). The hose should not be trapped, crushed or be in contact with sharp or abrasive edges.

Using a suitable leak detection fluid solution (e.g. Rocol) to check each gas connection one at a time. The presence of bubbles will indicate a leak. If there is a leak, tighten the fitting and then recheck for leaks.

## IMPORTANT

Do not test for leaks using a naked flame

## Converting from Natural Gas to LPG

To attach the appliance to a gas supply different from that for which it was set up (see gas type label inside the warming compartment door) proceed as follows:

- Remove the pan supports
- Remove the burners caps and burner heads
- With a 7mm socket screwdriver unscrew and remove the injectors.
- Replace the injectors with those supplied corresponding to the gas available (see Burner and Injector Characteristics table)
- Replace the various parts proceeding in reverse.
- Install with suitable hose compliant with the standards in force

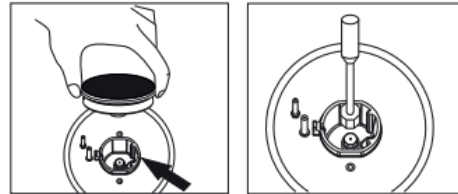

The flame on the small output is regulated by the factory.

When the injectors have been replaced, it will be necessary to regulate the minimum flame.

To regulate the minimum flame do the following:

- Light the burner
- Turn the knob to the minimum position
- Take out the knob (and gasket if there is one)
- Using a thin blade screwdriver to turn the by-pass screw located in the brass shaft (as shown right) turn screw fully clockwise then turn it anti-clockwise a 1/4 turn for the triple burner and 1/8 turn for all other burners. The result should be a small, stable flame which is uniform around the entire burner ring. If not, turn the by-pass screw anti-clockwise until satisfied with the flame
- Place the knob back on securely and turn it quickly from the maximum position to the minimum position, checking that the flame does not go out
- As the burners are fitted with a safety valve ensure the regulation obtained is sufficient to maintain heating of the thermocouple. If this is not the case, increase the minimum
- The burners do not require regulation of primary air.

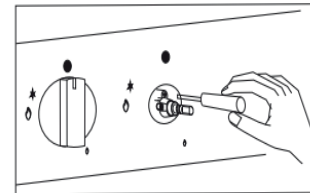

## Abnormal operation

ANY OF THE FOLLOWING ARE CONSIDERED TO BE ABNORMAL OPERATION AND MAY REQUIRE SERVICING:

- Yellow tipping of the hob burner flame.
- Sooting up of cooking utensils.
- Burners not igniting properly.
- Burners failing to remain alight.
- Burners extinguished by oven door.
- Gas valves that are difficult to turn.

If the appliance fails to operate correctly contact Caple Service e: [service@caple.co.uk](mailto:service@caple.co.uk) t: 0117 938 7420 .

## Burner and injector characteristic table

	Burner	By-pass (mm)	Consumption (*)							
			LPG							
			I3B/P(30)		I3+(28-30/37)				Natural gas I2H	
			G30		G30		G31		G20	
Input kw(g/h)	Main injector (mm)	Input kw(g/h)	Main injector (mm)	Input kw(g/h)	Main injector (mm)	Input kw(g/h)	Main injector (mm)			
1	Rapid	0.44	3.0 (218)	0.85	3.0 (218)	0.85	3.0 (214)	0.85	3.0	1.18
2	Semi-rapid	0.44	1.75 (127)	0.65	1.75 (127)	0.65	1.75 (125)	0.65	1.75	0.97
3	Auxiliary	0.44	1.0 (72.7)	0.50	1.0 (72.7)	0.50	1.0 (71)	0.50	1.0	0.72
4	Triple ring	0.44	3.7 (269)	0.95	3.7 (269)	0.95	3.7 (264)	0.95	3.7	1.40
Test point pressure			G30: 29mbar		G30: 29mbar G31: 37mbar				20mbar	

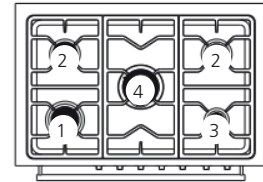

(\*) = With dry gas and with greater calorific power (Hs) at 15 and 1013.26mbar

## INSTRUCTIONS FOR USE

### GAS BURNERS

#### Description of the main parts of the appliance

### WARNING:

Read the instructions before installing or using this appliance.



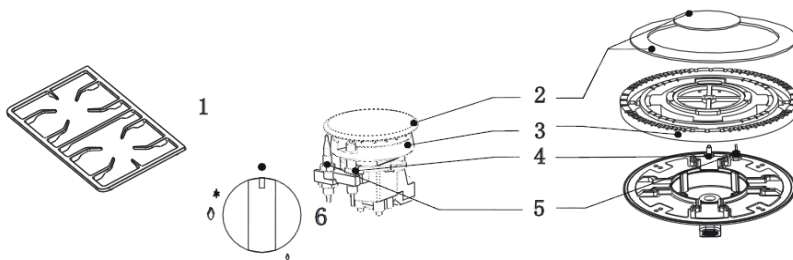









- This appliance should be installed in accordance with current regulations and should only be used in a well ventilated spaces. Do not use the appliance in a garage, basement and a room without windows, etc.
- Using a gas cooking appliance results in the production of heat and moisture in the room in which it is installed. Ensure that the kitchen is well ventilated: keep windows or doors open or use some form of extraction
- Prolonged intensive use of the appliance may require additional ventilation, for example opening a window, or for more effective ventilation, increase power level of extractor.



- 1 = pan support
- 2 = burner cap
- 3 = burner head
- 4 = spark plug
- 5 = safety valve
- 6 = control knob

Please keep this instruction manual for future reference

## Description of symbols

 FRONT LEFT BURNER	 FRONT CENTRAL BURNER	 CENTRAL BURNER
 REAR LEFT BURNER	 REAR CENTRAL BURNER	 ELECTRIC OVEN THERMOSTAT
 FRONT RIGHT BURNER	 LEFT CENTRAL BURNER	 MAIN OVEN (LEFT)
 REAR RIGHT BURNER	 RIGHT CENTRAL BURNER	 SMALL OVEN (RIGHT)

## Ignition and operation of the burners

In order to ignite a burner, press knob in and hold while rotating it anti-clockwise, do this until the index is aligned with the symbol corresponding to the maximum gas delivery (i.e. the large flame symbol).

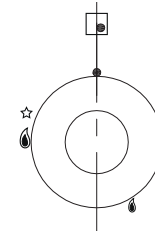

As this model is fitted with a safety valve once the flame is lit hold the knob and press for approx. 3-4 seconds until the burner stays lit. If the burner fails to ignite, wait one minute for the gas to dissipate before attempting to reignite. Once the flame is lit adjust the intensity by rotating the knob anti-clockwise, for example, from the maximum position to the minimum position (i.e. the small flame symbol). In order to turn the burner off, rotate the knob clockwise bringing the index back to its original position directing towards the closure symbol (•).

## Recommendations

In the event of a power failure, carry out the ignition operations described above by putting a gas lighter or a flame near the burner being careful not to burn yourself.

The model is fitted with safety valves that will automatically cut off the gas supply if the flame fails, blocking the gas delivery (e.g. if air blows out flame accidentally, spillage of liquids, etc.).

In any case, the ignition device must not be left on for longer than 15 seconds. Should the ignition manoeuvre fail, or should the burner accidentally turn off, immediately close the knob that was in use and repeat the ignition after one minute.

Once reignited, adjust the flame according to your requirements.

## Advice on the use of gas burners

For lower gas consumption and a better yield, use saucepans with diameter suitable for the burners, avoid the flame coming up around the side of the saucepan (see the Container Table).

Use only flat-bottomed pans.

As soon as liquid starts to boil, turn the flame down to a level sufficient to maintain boiling.

During cooking, when using fats and oils, be very careful not to overheat as it may catch fire.

Container Table (use flat-bottomed saucepans)

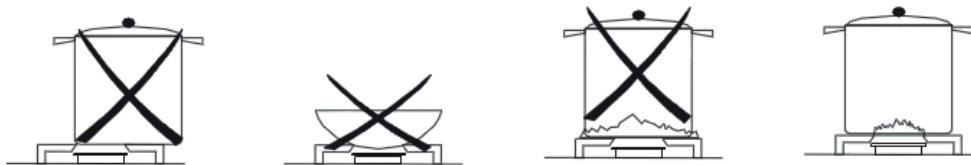

Burner	Saucepan min. Ø (mm)	Saucepan max. Ø (mm)
Auxiliary	90	160
Semi-rapid	130	180
Rapid	150	260
Triple ring	210	260

Please keep this instruction manual for future reference



## INSTRUCTIONS FOR USE

FOR OVEN COOKING

### Electric oven thermostat knob



Select cooking temperature by turning the knob clockwise to the required temperature – between 60°C and the MAX. The warming light will come on when the oven is heating up, the light will turn off when it has reached the required temperature. If the light begins to flash it means the oven has constantly maintained the selected temperature for a long period of time.

### Electric oven control knobs

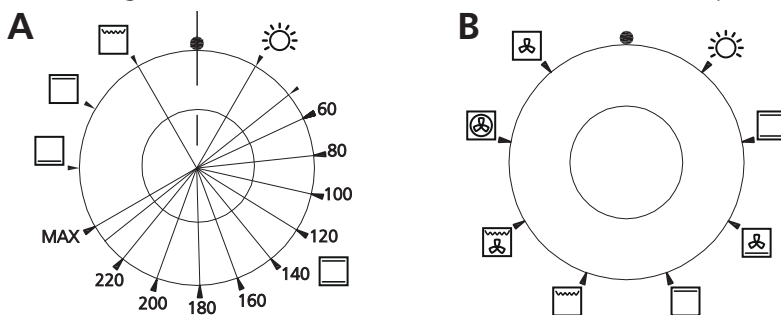
All cooking functions listed below must be used with the temperature range shown



#### Control A (small oven):

Top heat , Base heat  and grill  functions are all present to MAX (250°C).

The temperature selection section sets the conventional function  in the small oven.

Control A is for controlling the small oven only. Control B is used to select the required function for the main oven, then use the temperature dial to control the temperature for the main oven only.

### LIGHT

During use the light will remain on, the lamp can be turned on independently of any heating elements

### CONVENTIONAL

Thermostat between 60°C and MAX

The heat is provided from the top and bottom elements. The oven must be preheated before the food is placed inside. Static cooking provides optimum results with: cakes, pizzas, bread and for slow cooking of casseroles. Characteristics of static cooking: heat provided from above and below, cooking is possible only on middle shelf and should be centrally located in the oven.

### BASE HEAT

Thermostat between 60°C and MAX

Ideal for pastries and cakes and moist desserts in moulds. For best results complete cooking at the bottom especially with dishes requiring heat from the base. For maximum heat food is best placed at the bottom level.

### TOP HEAT

Thermostat between 60°C and MAX

Top oven – perfect for browning food at the end of cooking

### GRILL

Thermostat between 60°C and MAX

Grill element – use for toasting, melting cheese or browning. The pre-heat time should be no longer than 5 minutes. To operate, please select Full Grill function along with the temperature.

### TURBO GRILL

Thermostat between 60°C and 200°C

Grill Element and Fan – use for grilling meats, vegetables and poultry. Pre-heat oven, place food on grill rack in baking tray and place in the middle of the oven. Other food may be cooked underneath whilst grilling, the oven door must be closed for while grilling.

Please keep this instruction manual for future reference

## FAN HEAT

Thermostat between 60°C and MAX

The circular heating element and fan operate simultaneously spreading the heat evenly throughout the oven cavity. Various types of food can be cooked on different shelves, naturally with the appropriate cooking times. The oven must be preheated before the foods are placed inside. Fan Heat provides optimum results for: cakes, large quantities of foods and cooking various dishes simultaneously. To operate, please select Fan Heat function along with the temperature.

## TURBO DEFROST

Thermostat – no temperature selected

The fan located at the bottom of the oven makes the air circulate at room temperature around the food. This is recommended for the defrosting of all types of food, in particular, for food that does not require a lot of heat such as ice cream, cakes, cream or custard desserts. By using the fan, the defrosting time is approximately halved. In the case of meat, fish and bread, it is possible to accelerate the process using the Fan Heat and setting the temperature between 80°C and 100°C

## NOTE:

All the functions mentioned above switch the oven internal light on. A warning light on the control panel will stay lit until the temperature is reached; after it will light up intermittently. The oven door must be closed for all cooking methods.

## Electronic programmer

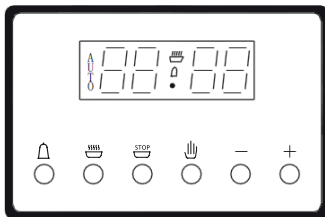

## LED programmer



- Showing time (0:00-24:00) and minutes.
- The screen shows 3 numbers and "AUTO" if the power is on
- To set the time, press the  button first, then + or – button to change digits to the correct time



## Manual operation setting

- If "AUTO" is flashing (automatic or a semi automatic program has been set), press  button to remove "AUTO" – the manual operation process is now on.

## Automatic setting

(set the full automatic starting and ending)

1. Press  button, set cooking time.
  2. Press  button, set finish time.
  3. Set temperature and cooking function by turning the thermostat knob and selector knob.
- After the setting above, "AUTO" will be flashing, which means the cooking process of the oven is set.

For example: if cooking time is 45 minutes and finish time is 14:00, press  and set cooking time to 45 minutes, then press  and set finish time to 14:00.

After the above setting, the screen will show the real time (hours and minutes) and "AUTO" will flash, this indicates the cooking time has been set.

When the clock turns to be 13:15 or between 13:14-13:15, the oven will automatically start the cooking process –  and "AUTO" should flash

When the clock turns to 14:00 cooking will automatically end, the alarm will sound and "AUTO" will flash.



To stop alarm press 



## Semi-automatic setting



Set the time of automatic starting and ending

### A. Set the time limit of cooking (10 hours maximum):

Press the  button to set the cooking time. The oven will start immediately –  and “AUTO” will flash.



Once cooking time is finished, the cooking process will stop automatically. “AUTO” will then flash and the alarm will sound. To stop alarm press .

### B. Set the finishing time (23 hours 59 minutes maximum):

Press the  button to set the finish time. The oven starts immediately and “AUTO” will flash. Once the oven reaches the finishing time the cooking process will stop automatically –  “AUTO” will then flash and the alarm will sound. To stop alarm press .

Whenever the related button is pressed, the set cooking process will be seen. Press the button and set to ‘0’ to cancel the cooking process – press the button again and the oven will be ready for manual operation.

Timer: 23 hours 59 minutes can be set as maximum.

When setting cooking time, press the  button and then + or – button, until the required cooking time shows on the screen. Once cooking time has been set the display will return to the time (hour, minute) press the  button to display remainder of cooking time.

Whenever the  button is pressed the remaining time will be shown.

When the set time reaches, the alarm will ring. To stop alarm press .

### Note:

After pressing the required button, the setting will be selected within 5 seconds. In the event of a power-cut, the display will turn off and the set times and real time (hour, minutes) will not display. Once power is back on, three “0” and “AUTO” show on the screen, this mean the oven has been automatically reset.

## Cooling ventilation

In order to cool down the exterior of the appliance, the model is equipped with a cooling fan, which comes on automatically when the oven is hot. When the fan is on, a normal flow of air can be heard exiting between the door and the control panel.

### Note:

When cooking is finished, the fan stays on until the oven cools down sufficiently.

## INSTRUCTIONS FOR COOKING

### Oven Cooking

For a perfect cooking, pre-heat the oven to the pre-set cooking temperature.

It is recommended only very large cuts of meat should be placed into a cold oven to minimise food splashes in the oven that can sometimes produce smoke. Use a deep baking dish to minimise this risk or high-edged containers, preferably ceramic containers to be placed on a shelf in the middle of the oven. The Table of Cooking Times show some examples of how to set the thermostat and the cooking time. The cooking time can vary according to the type of food, its size and volume. The table is acting as a guide please be aware some values may vary in different instances.

### Practical ways to save energy

The oven can be switched off some minutes before cooking end as the residual temperature is enough to complete cooking. Open the oven door only when it is absolutely necessary, if you wish to check on food look through the glass (the oven lamp is always on).

### General Advice

The oven offers various kinds of cooking functions:

- Conventional cooking for the cooking roasts
- Fan heat for cooking cakes and biscuits.

If fan heat is the selected cooking function it is recommended to take full advantage of it, cooking a variety of foods on different shelves can save time and energy.

### FAN ASSISTED

A continuous circulation of warm air is created, which allows food to be placed and cooked on different shelves at the same time. The oven will reach the pre-set temperature in a very short time.

### CONVENTIONAL COOKING

This is especially suitable for cooking meat that requires long, slow cooking as well as for cooking bread and sponge cakes. It is advisable to place the food into the oven when it has reached the selected cooking temperature (when the thermostat light goes out).

### GRILL COOKING

Pre-heat the oven for about 5 minutes. During grill operation the heat comes from above; it is based on the infrared radiation and is good for thinner cuts of meat and toasting. For best results, oil meat and fish and place on a grate/shelf. Depending on the thickness of the meat/fish place either closer or further away from grill element. .

The Table of Cooking Times shows some examples of cooking times and food positions. The cooking times vary according to the type of food, its size and volume.

### COOKING PASTRY

The air circulation of the oven assures an instantaneous and even heat distribution so there is no need to preheat the oven. However for delicate pastry the oven can be pre-warmed. More trays can be inserted into the oven together with the pastries, taking care not to use the top shelf position.

### COOKING TIMES

The Table of Cooking Times shows some examples for the adjustment of the thermostat and of the cooking time. The cooking times can vary according to the type of food and volume. The table is acting as a guide only please be aware some values may vary in different instances.





### Note

The times indicated in the table refer to the cooking of one portion only; for more than one portion, the cooking times should be increased by 5 -10 minutes (follow the recommended cooking instructions on the food packaging)





## TABLE OF COOKING TIME

The table below provides indicative shelf positions for use with your oven. Please note, the temperature and cooking times are to be used as a guide. According to different cooking habits, it may be necessary to make further modifications. Please add 15 minutes to the times indicated for preheating.

COOKING FUNCTION	FOOD TYPE	WEIGHT (kg)	SHELF POSITION	PREHEATING TIME (mins)	Temperature (°C)	Time (mins)
Conventional cooking 	Duck	1	3	15	200	65-75
	Roast veal or beef	1	3	15	200	70-75
	Roast pork	1	3	15	200	70-80
	Biscuits (short pastry)	-	3	15	180	15-20
	Tarts	1	3	15	180	30-35
Top heat 	Perfect for browning food	-	3-4		220	15
Grilling 	Sole and cuttlefish	1	4	5	Max	8-10
	Squid and prawns	1	4	5	Max	6-8
	Kebabs	-	-	-	-	
	Cod fillet	1	4	5	Max	10
	Grilled vegetables	1	3/4	5	Max	10-15
	Veal steak	1	4	5	Max	15-20
	Cutlets	1	4	5	Max	15-20
	Hamburgers	1	4	5	Max	7-10
	Mackerel	1	4	5	Max	15-20
	Toasted sandwiches	-	4	5	Max	2-3
	Chicken	1.5	-	5	Max	70-80
Lamb	1	-	5	Max	70-80	
Turbo grill 	Veal	1.5	-	5	200	70-80
	Potatoes	1.5	2	5	200	70-75
	Lamb	1.5	-	5	200	70-80
	Grilled chicken	1.5	3	5	200	55-60
	Cuttlefish	1.5	3	5	200	30-35

Please keep this instruction manual for future reference

COOKING FUNCTION	FOOD TYPE	WEIGHT (kg)	SHELF POSITION	PREHEATING TIME (mins)	Temperature (°C)	Time (mins)	
Fan heat 	Tarts	0.5	3	15	180	20-30	
	Cakes	1	2/3	15	180	40-45	
	Fruit cake	0.7	3	15	180	40-50	
	Sponge cake	0.5	3	15	160	25-30	
	Stuffed pancakes (on 2 racks)	1.2	2-4	15	200	30-35	
	Small cakes (on 2 racks)	0.6	2-4	15	190	20-25	
	Cheese puffs (on 2 cakes)	0.4	2-4	15	210	15-20	
	Cream puffs (on 3 cakes)	0.7	1-3-5	15	180	20-25	
	Biscuits (on 3 racks)	0.7	1-3-5	15	180	20-25	
	Meringues (on 3 racks)	0.5	1-3-5	15	90	180	
	Defrosting 	All frozen food					

Shelf positioning:

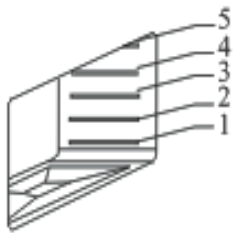

## Maintenance and cleaning

Do not steam clean appliance

- Before any maintenance or cleaning disconnect the appliance from the mains.
- Wash the enamelled parts with lukewarm water and detergent then dry immediately.
- Do not use abrasive products.
- Wash the burner outlet frequently with hot water and detergent make sure to remove any deposits which could block the flame outlet.
- Rinse the stainless steel parts thoroughly with water and dry them with a soft cloth.
- To clean the hob use slightly damp sponges and wiping cloths: do not use excessive amounts of water, if too much water is used it could penetrate the internal parts and damage electrical components. The pan supports of the hob can be washed in the dishwasher, dry immediately once dishwasher cycle has ended.
- For persistent stains use normal non-abrasive detergents or a little hot vinegar. Clean the glass parts with hot water, avoiding the use of rough cloths.
- Do not use stainless steel pads or acids for cleaning.
- To prevent ignition difficulties, carefully clean the lighting spark plugs regularly (ceramic and electrode).
- If the knobs become difficult to turn, contact a qualified engineer to lubricate the taps. Contact a qualified engineer to deal with any other problems which may arise during use.
- To prolong the brightness of enamelled parts clean after every use. Once the oven is cold, you will be able to easily remove the fat deposits using a sponge or cloth damp with warm soapy water or a non-abrasive detergent. Never use abrasive cloths or sponges that could cause permanent damage the enamel. DO NOT clean while hot.
- Always clean the appliance immediately after spillage to minimise permanent damage, it is recommended that the product is inspected at least every 5 years by an authorised technician.

Please keep this instruction manual for future reference



## Cleaning the lower grill

Only applicable for ovens with lower grill

### WARNING:

- Ensure all controls are in the "OFF" position and wait for the grill element to cool down.
- Support the front of the grill element while you remove the knurled screw. Lower the front of the element carefully to the rest position.
- When cleaning the oven make sure do not apply any forces to the grill element
- When cleaning is complete, carefully remove any cleaning chemicals and water from the grill element.
- Carefully raise the front of the element into position and secure with the knurled screw.
- Never use the oven when grill element is hanging down or not properly secure

### IMPORTANT:

Before using the oven and burners after cleaning please ensure:

- All parts are correctly positioned before igniting the burners again.
- All pan supports have rubber pads on and they are positioned correctly to increase stability and avoid scratches

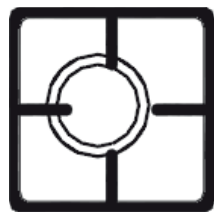

INCORRECT

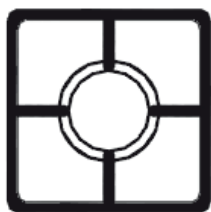

CORRECT

## How to remove the oven door

For a more thorough clean you can remove the oven door.

According to different structure of oven door purchased proceed as follows:

Oven door remove and assemble procedure:

- Open the door fully
- Lift up and turn the small levers situated on the two hinges
- Grip the door on the two external sides, shut it slowly but not completely
- Pull the door towards you pulling it out of its seat
- Reassemble the door by following the above procedures backwards.

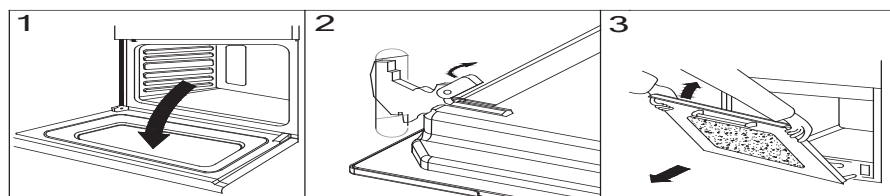

## Replacing the oven lamp

- Disconnect the oven from the power supply from the omni-polar switch used to connect the appliance to the electrical mains.
- Remove the glass cover of the lamp
- Remove the lamp and replace with a heat resistant lamp ensuring it is suitable for temperatures up to 300°C with the following characteristics:
  - Voltage: 220-240V
  - Wattage: 25W
  - Type: E 14
- Replace the glass cover and reconnect the oven to the mains power supply.

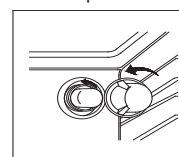

Please keep this instruction manual for future reference





Please keep this instruction manual for future reference





Please keep this instruction manual for future reference





Cable Service  
Fourth Way  
Avonmouth  
Bristol  
BS11 8DW

t: 0117 938 7420  
e: [service@caple.co.uk](mailto:service@caple.co.uk)  
[www.caple.co.uk](http://www.caple.co.uk)

Please keep this instruction manual for future reference

