



# QC900SS

Caple Quad 900mm Chimney



GB

INSTRUCTION ON MOUNTING AND USE

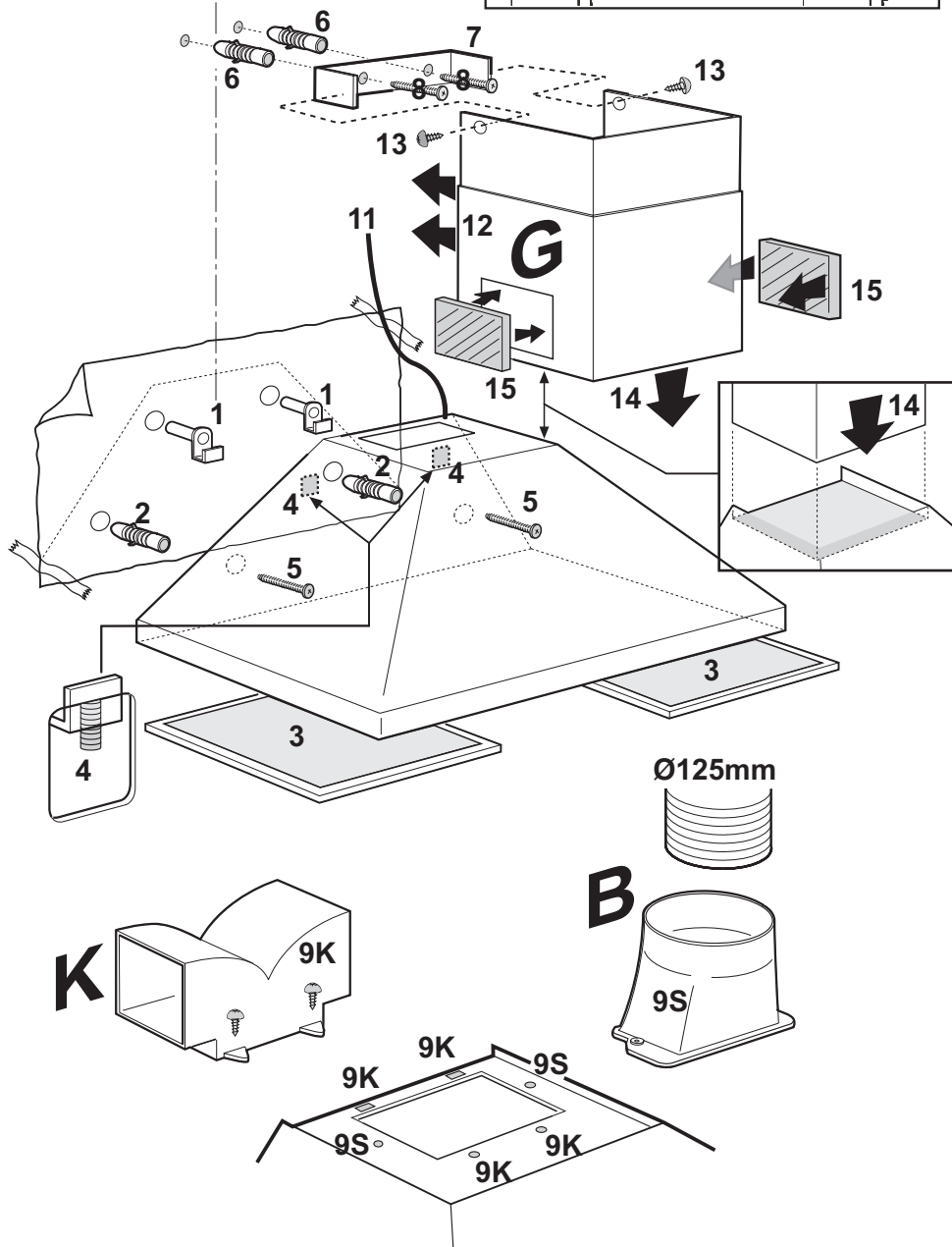
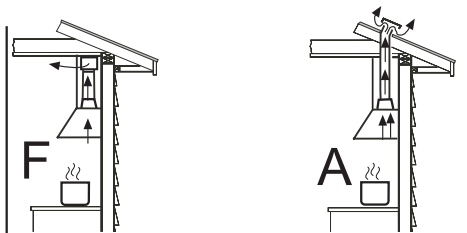

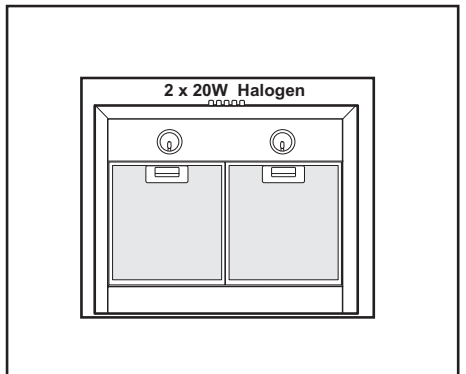
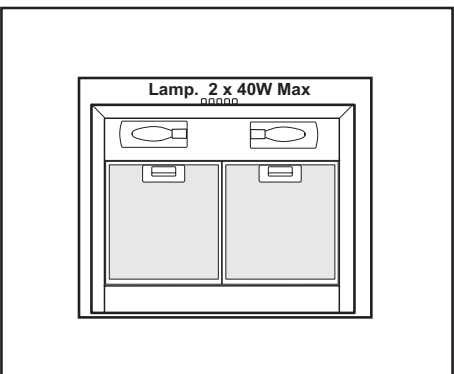
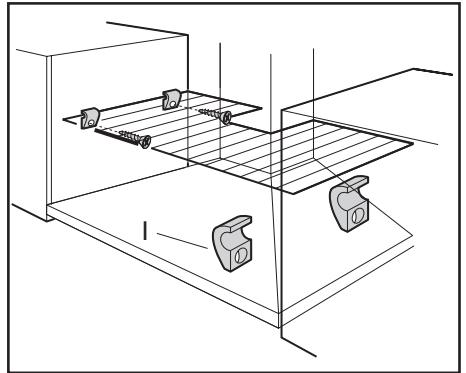
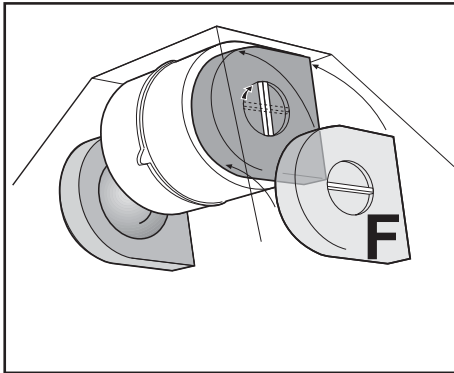
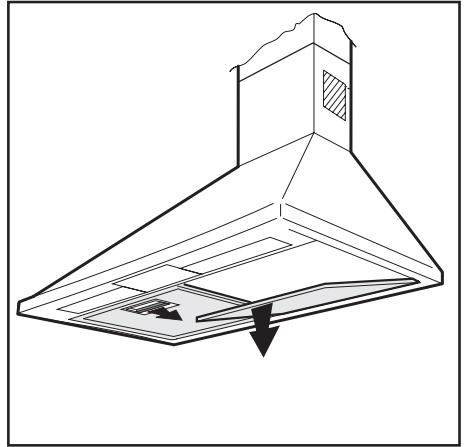
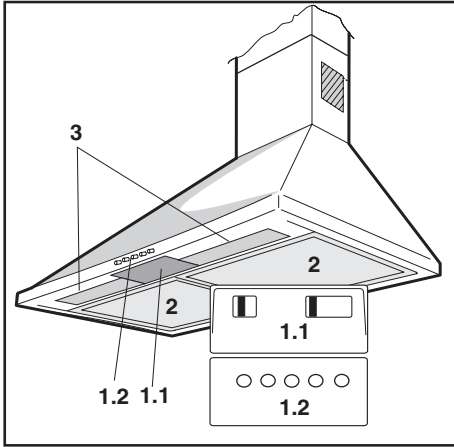

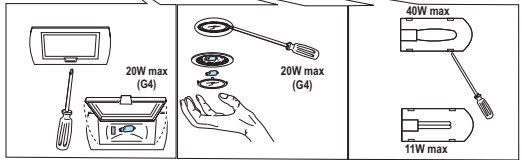
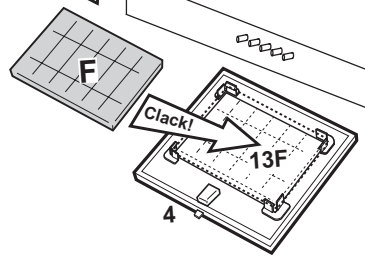
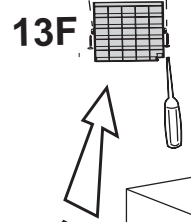
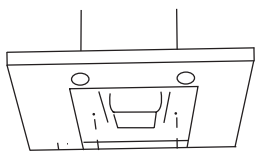
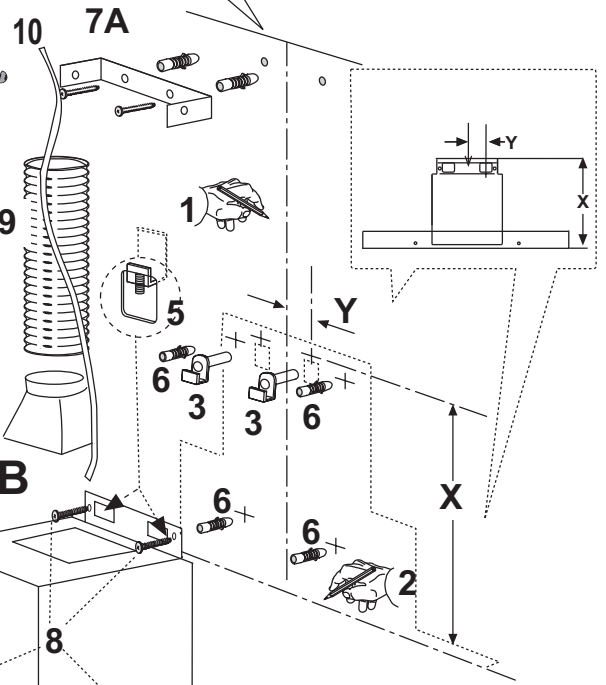
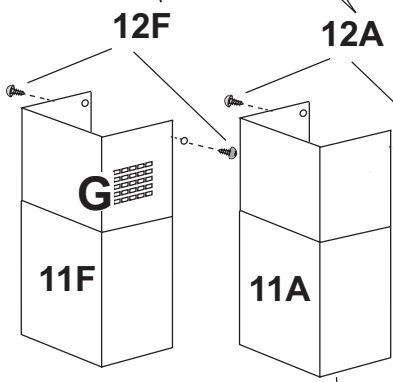
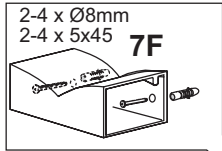
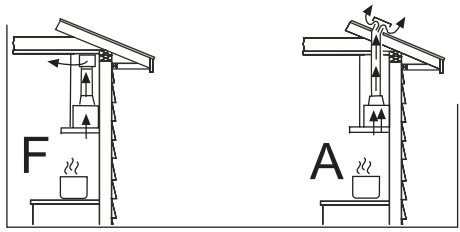
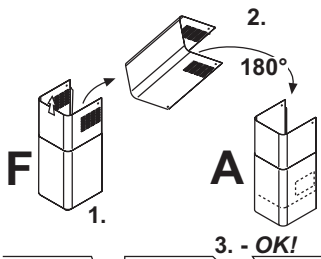

# GB INSTRUCTION ON MOUNTING AND USE

Consult the designs in the front pages referenced in the text by alphabet letters. Closely follow the instructions set out in this manual. All responsibility, for any eventual inconveniences, damages or fires caused by not complying with the instructions in this manual, is declined.

## Installation

The cooker hood must be placed at a minimum distance of 65 cm from the cooking plane for electric cookers and 75cm for gas or mixed cookers.

If the instructions for installation for the gas hob specify a greater distance, this has to be taken into account.

Do not tile, grout or silicone this appliance to the wall. Surface mounting only. Do not fix chimney flue to furniture or fly over shelves unless the chimney flue can be easily removed, in case maintenance is ever required.

## Use

The cooker hood is provided with an upper air exit B for discharging fumes externally for models including chimney flue (Suction Version A - exhaust pipe not supplied).

If cooking fumes and vapours cannot be externally discharged, the cooker hood can be used in the recirculating version F: the installation of 1 active charcoal filter F allows the recirculation of fumes and vapours through the upper grid G.

## Electrical connection

The electrical tension must correspond to the tension noted on the label placed inside the cooker hood. Connect the electrical plug, where provided, to the an easily accessible outlet in conformity with local standards in force.

Where an electrical plug is not provided (for direct connection to electrical network) place a standards approved bipolar switch with an aperture distance of not less than 3mm (accessible) from the contacts.

## Functioning

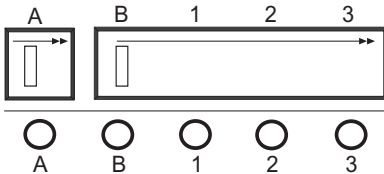

A. Lights ON/OFF

B. Motor speed OFF

1 - 2 - 3. Adjustment hood speed: minimum (1), average (2), maximum (3)

In the case of an excessive concentration of steam, adjust the hood to maximum speed. We advise starting the hood five minutes before beginning to cook and continue the function for at least 15 minutes after having finished cooking.

## Maintenance

Prior to any maintenance operation ensure that the cooker hood is disconnected from the electrical outlet.

### Cleaning:

The cooker hood should be cleaned regularly internally and externally.

For cleaning use a cloth moistened with denatured alcohol or neutral liquid detergents. Avoid abrasive detergents.

**Warning:** Failure to carry out the basic standards of the cleaning of the cooker hood and replacement of the filters may cause fire risks. Therefore we recommend observing these instructions.

### Anti-grease Filter:

must be cleaned once a month, with non abrasive detergents, by hand or in dishwasher on low temperature and short cycle.

When washed in a dishwasher, the grease filter may discolour slightly, but this does not affect its filtering capacity.

### Charcoal Filter (only for filter version):

The active charcoal filters F are not washable nor regenerative. It should be changed every 6 months in normal use.

*The active charcoal filters capture unpleasant cooking odours.*

### Replacing lightbulbs:

**Warning!** Prior to touching the light bulbs ensure they are cooled down.

Extract the lamp cover by levering it off with a small screwdriver or similar tool.

Replace the damaged light bulb.

Close the lamp cover (it will snap shut).

### Fastening of shelves (optional):

Fasten the four side supports (I) to the adjacent cabinets and place the shelf on the supports.

## Caution

This appliance is designed to be operated by adults. Children should not be allowed to tamper with the controls or play with the appliance.

Do not use the cooker hood where the grill is not correctly fixed! The suctioned air must not be conveyed in the same channel used for fumes discharged by appliances powered by other than electricity. The environment must always be adequately aerated when the cooker hood and other appliances powered by other than electricity are used at the same time. Flambé cooking with a cooker hood is prohibited. The use of a free flame is damaging to the filters and may cause fire accidents, therefore free flame cooking must be avoided. Frying of foods must be kept under close control in order to avoid overheated oil catching fire. Carry out fumes discharging in accordance with the regulations in force by local laws for safety and technical restrictions.

This appliance is marked according to the European directive 2002/96/EC on Waste Electrical and Electronic Equipment (WEEE). By ensuring this product is disposed of correctly, you will help prevent potential negative consequences for the environment and human health, which could otherwise be caused by inappropriate waste handling of this product.



The symbol  on the product, or on the documents accompanying the product, indicates that this appliance may not be treated as household waste. Instead it shall be handed over to the applicable collection point for the recycling of electrical and electronic equipment. Disposal must be carried out in accordance with local environmental regulations for waste disposal.

For more detailed information about treatment, recovery and recycling of this product, please contact your local city office, your household waste disposal service or the shop where you purchased the product.